

# Assembly Instructions

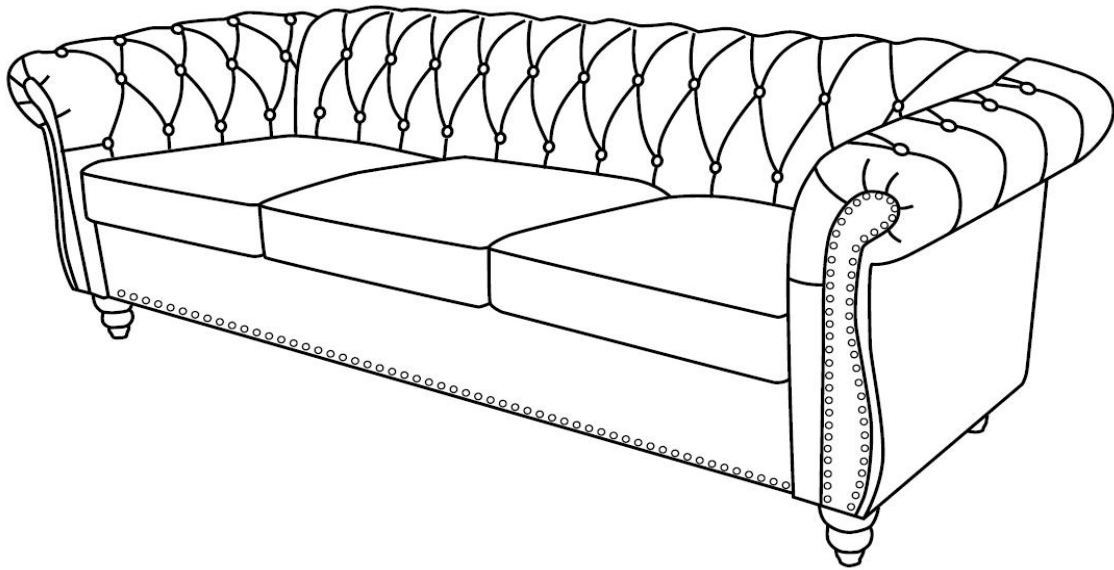



**Caution: You must read this before you proceed**

**Please look in the magic tape pouch for hardware packs and legs**

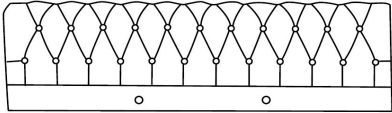
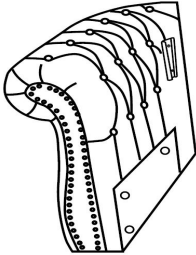
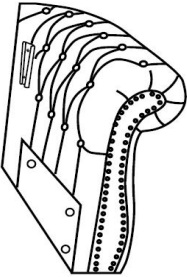

## SOFA

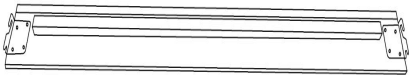

## Part List

Label	Picture	Description	QTY
A		Backrest	1
B		Left Armrest	1
C		Right Armrest	1
D		Seat	1
E		Front Rail	1
F		Seat Cushion	3
G		Leg	4

## Hardware List

Label	Picture	Description	QTY
①		Plastic Washer	7
②		Allen Wrench	1

## Assembly Preparation

Before Beginning  
Assembly:

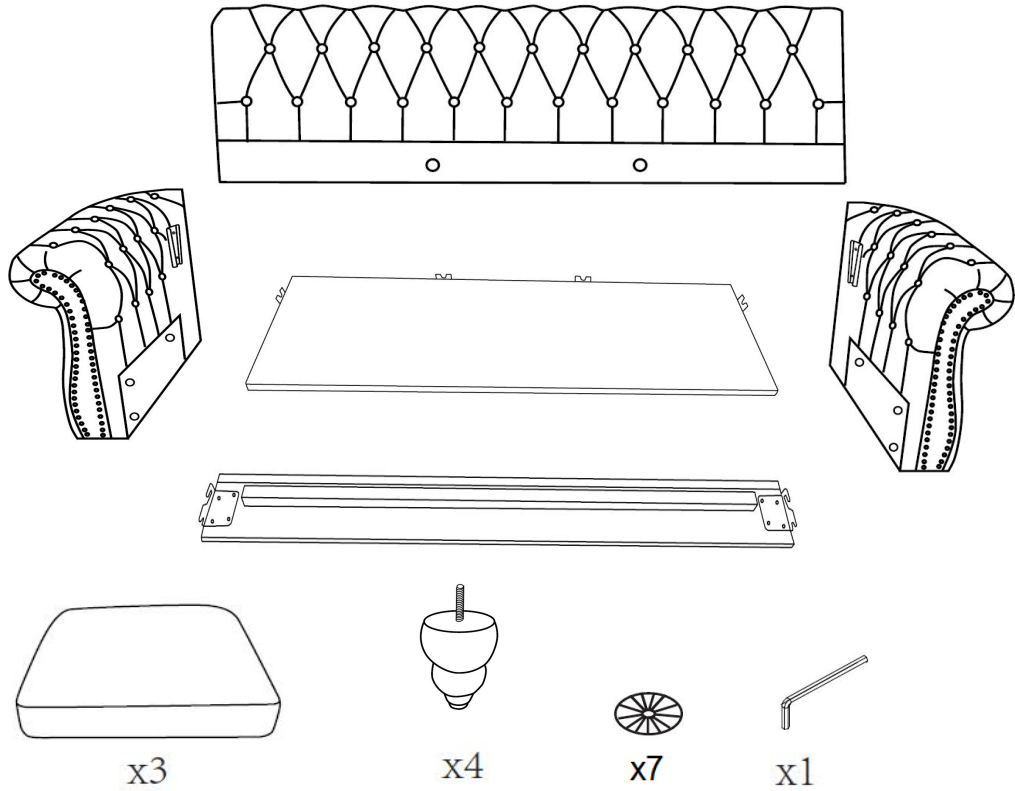

- Read instructions, cover to cover-



- Have 2 adults on hand for assembly-



- Do not assemble on flooring or carpet-



- Assemble on a clean non-marring surface (packing foam)-



- Save all packaging until finished-

## Assembly Steps

### OVERVIEW

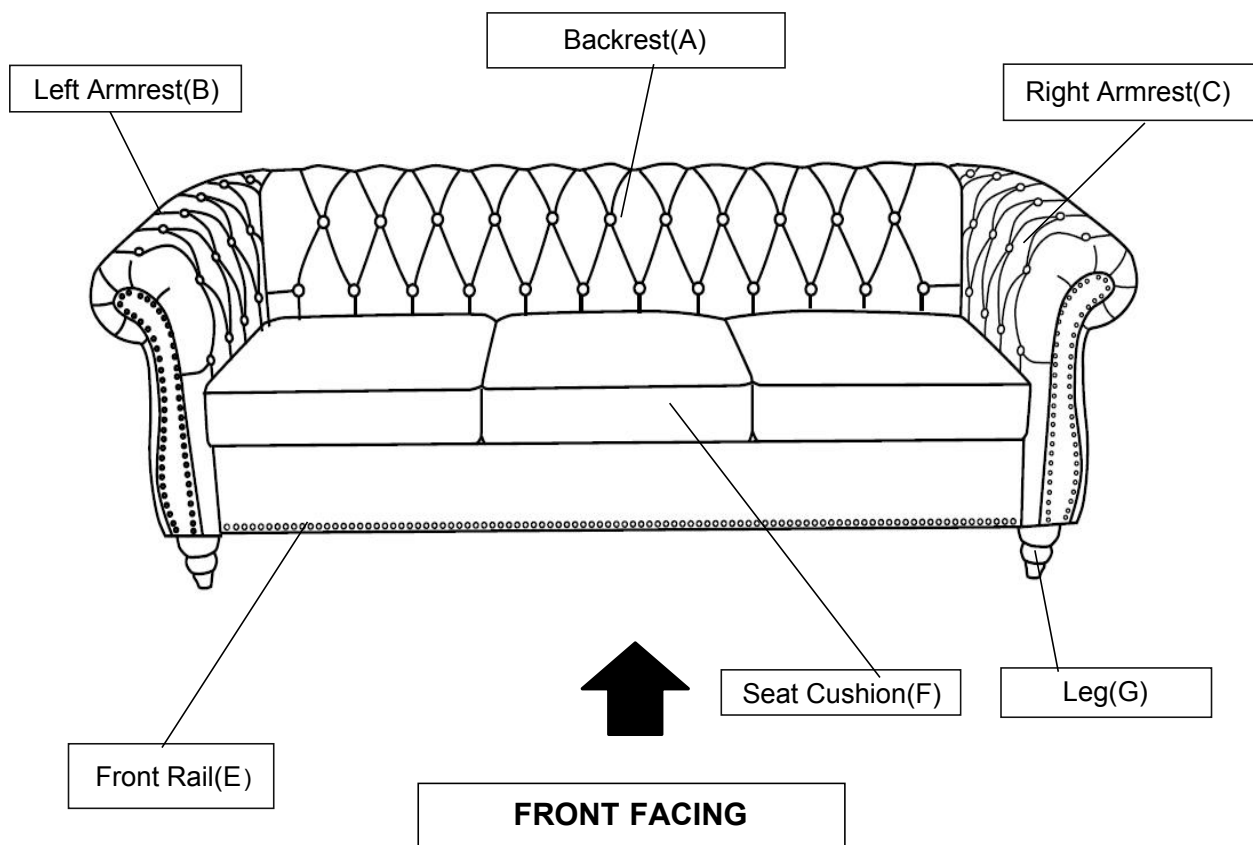

This Sofa has multiple parts and may require up to 60 minutes to assemble. To give you an overview of the Sofa parts, the above picture is to help you put the various parts into perspective. Please read through the instructions below to familiarise yourself with the parts and steps before assembly.

**Note: It is recommended that you have an adult partner to assist during the entire assembly process.**

**Step 1**

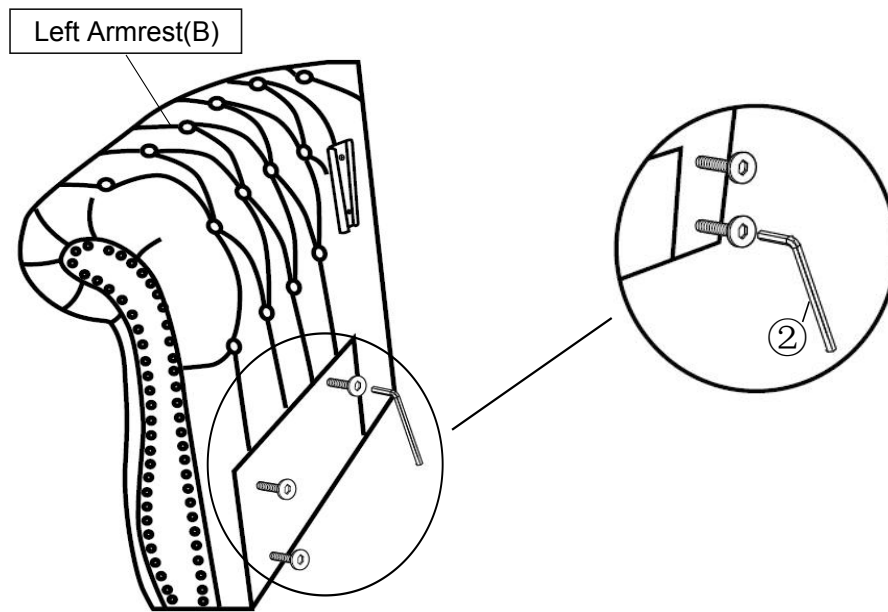

Open the carton and place all the parts on a clean, non-marring surface.  
Loosen the 3 bolts in Left Armrest(B) around half inch by Allen Wrench(2).  
Repeat the same step to loosen 3 bolts in Right Armrest(C).

**Step 2**

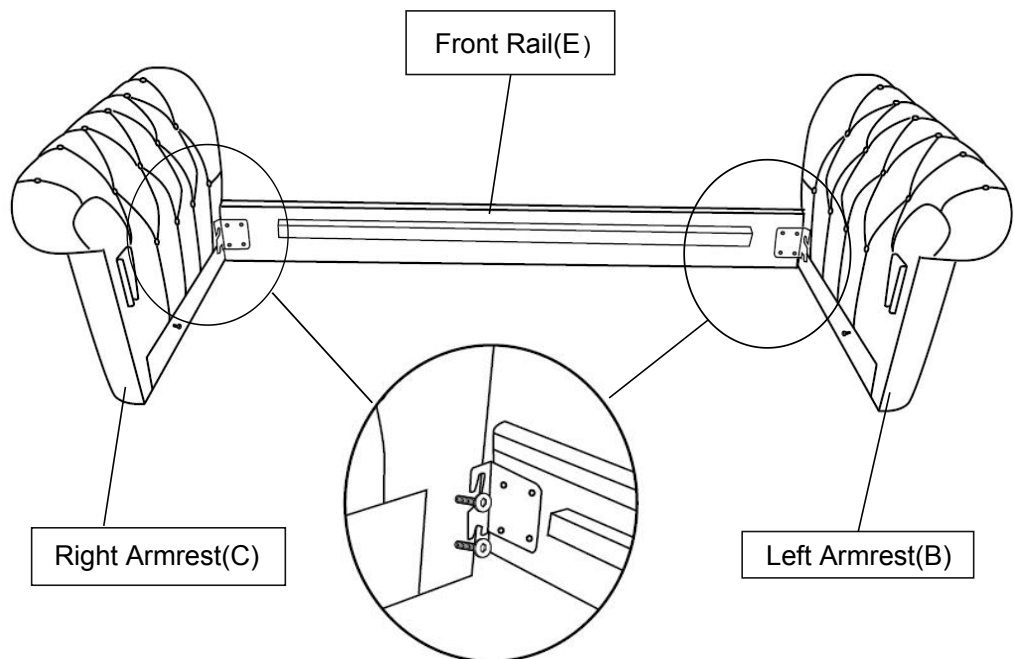

With the assistance of your partner, slide the hook in the end of Front Rail(E) into the bolts on the Left Armrest(B) and Right Armrest(C).

### Step 3

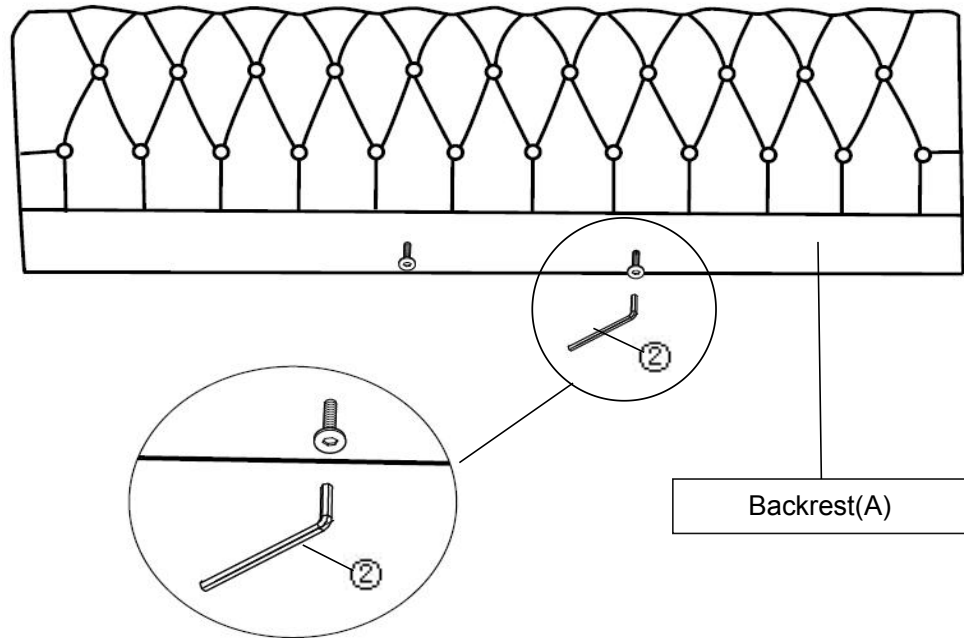

Loosen the 2 bolts in Backrest(A) around half inch by Allen Wrench(②).

### Step 4

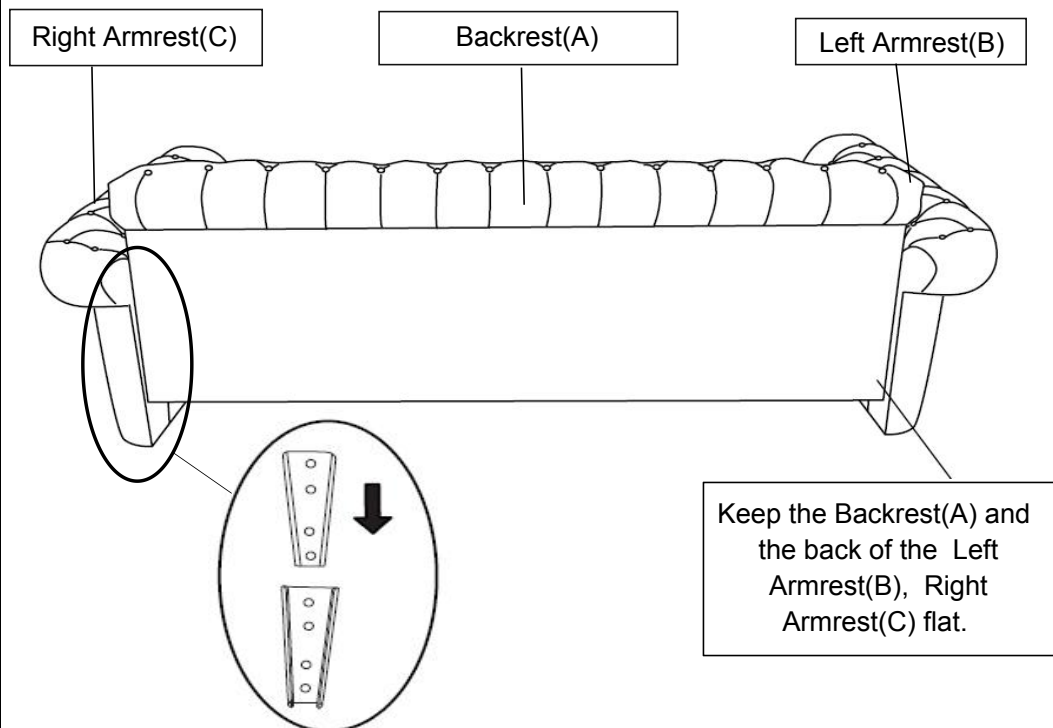

Slide the Tapered Connectors on the Backrest(A) into the Tapered Connectors on the Left Armrest(B) as shown in the picture.

Repeat the same process with the Right Armrest(C).

Note: Make sure the Tapered Connectors on Backrest(A) lock into the Tapered Connectors on the Left Armrest(B) and Right Armrest(C).

Keep the Backrest(A) and the back of the Left Armrest(B), Right Armrest(C) flat.

Assistance from an adult partner is necessary for this assembly process.

During this assembly process - do exercise caution. You may need to use your hand to press down and or pave away the padded surface to facilitate the 'slip and slide' assembly.

Caution: Ensure that your fingers do not get caught or pinched in the assembly process.

### Step 5

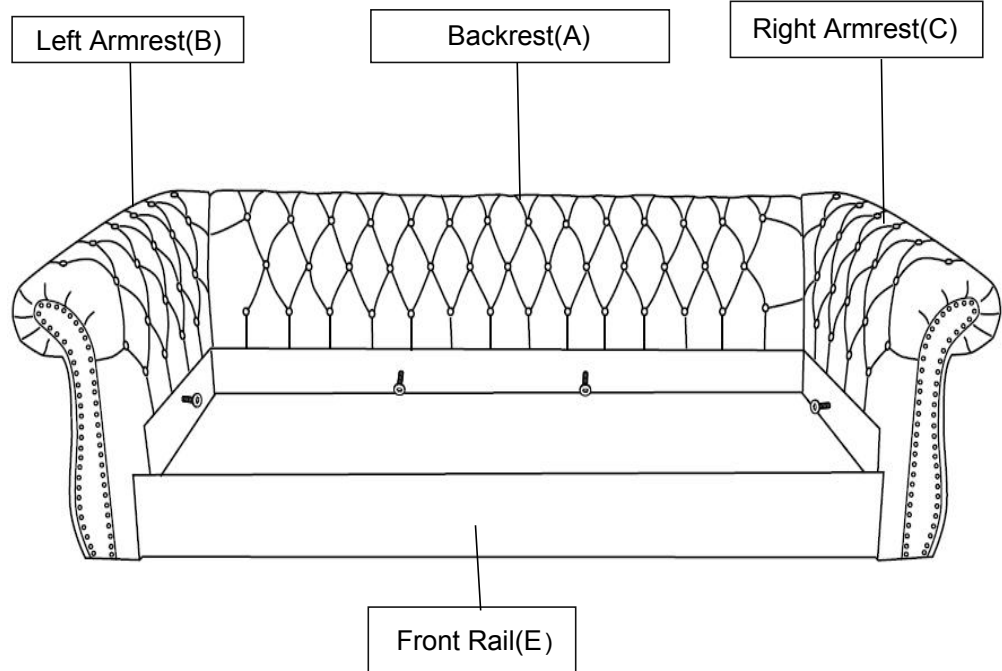

Turn the sofa upside down and place it on the front as shown.  
Assistance from an adult partner is necessary for this assembly process.

### Step 6

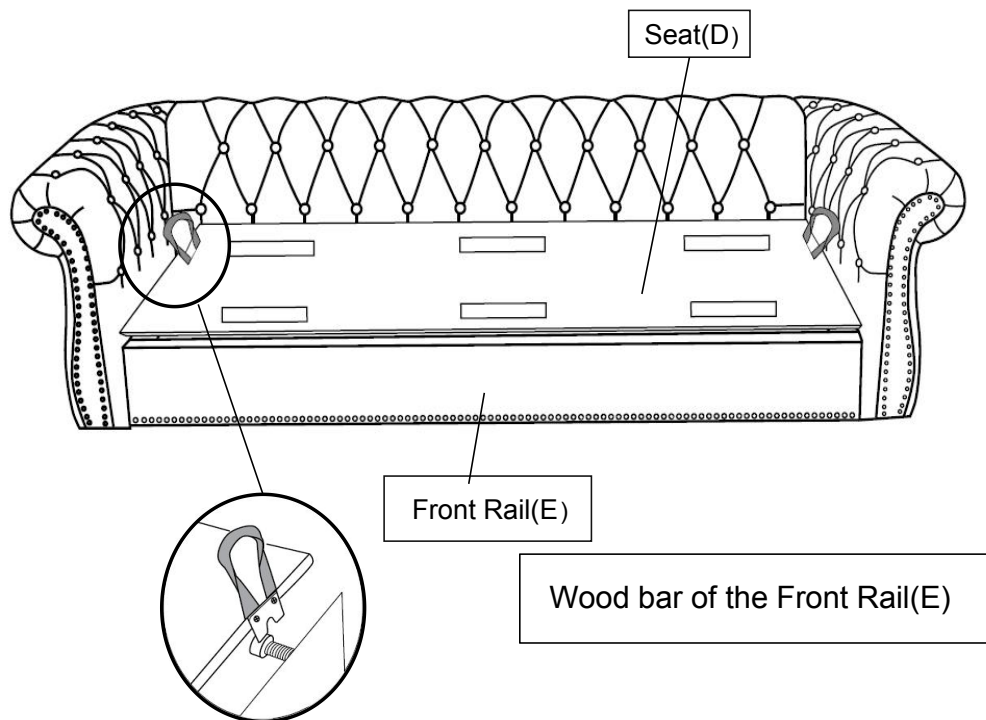

With the assistance of your partner, lift the rope on the two sides of Seat(D) by hand.  
Put the Seat(D) on the wood bar of the Front Rail(E) and then slowly place it down as shown above.  
**Note: All the u-shaped iron sheet need clamped to the bolt.**

**Step 7**

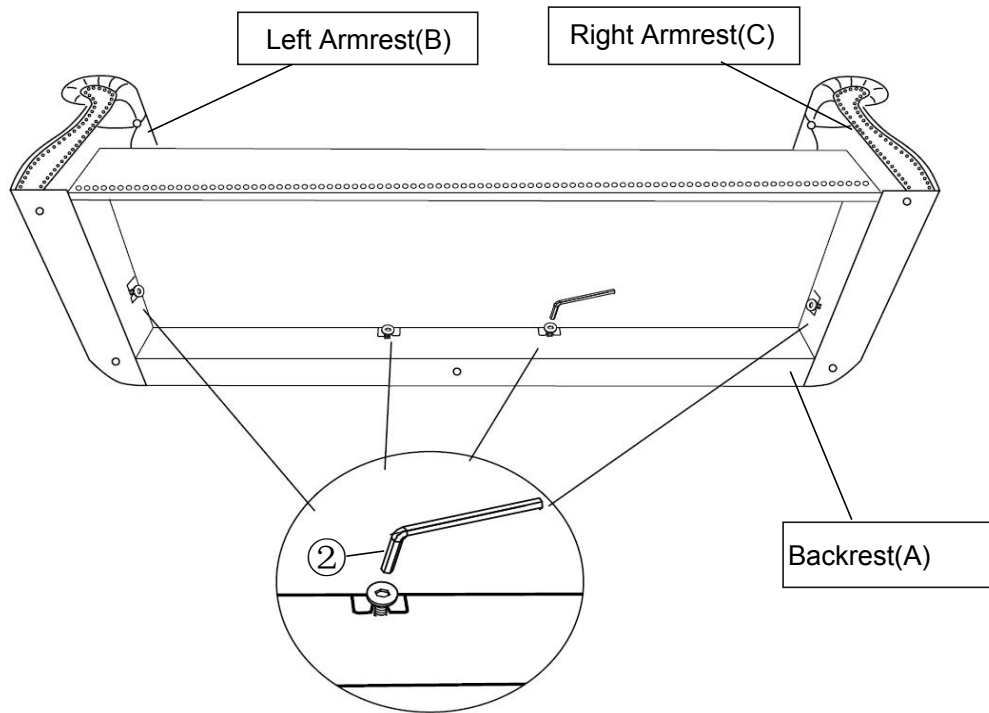

Tilt and lay the Sofa onto a flat surface.

Tighten the Bolts in the bottom of Backrest(A), Left Armrest(B) and Right Armrest(C) by Allen Wrench(②) as pictured above.

Tighten the Bolts fully in a sequential manner.

**Step 8**

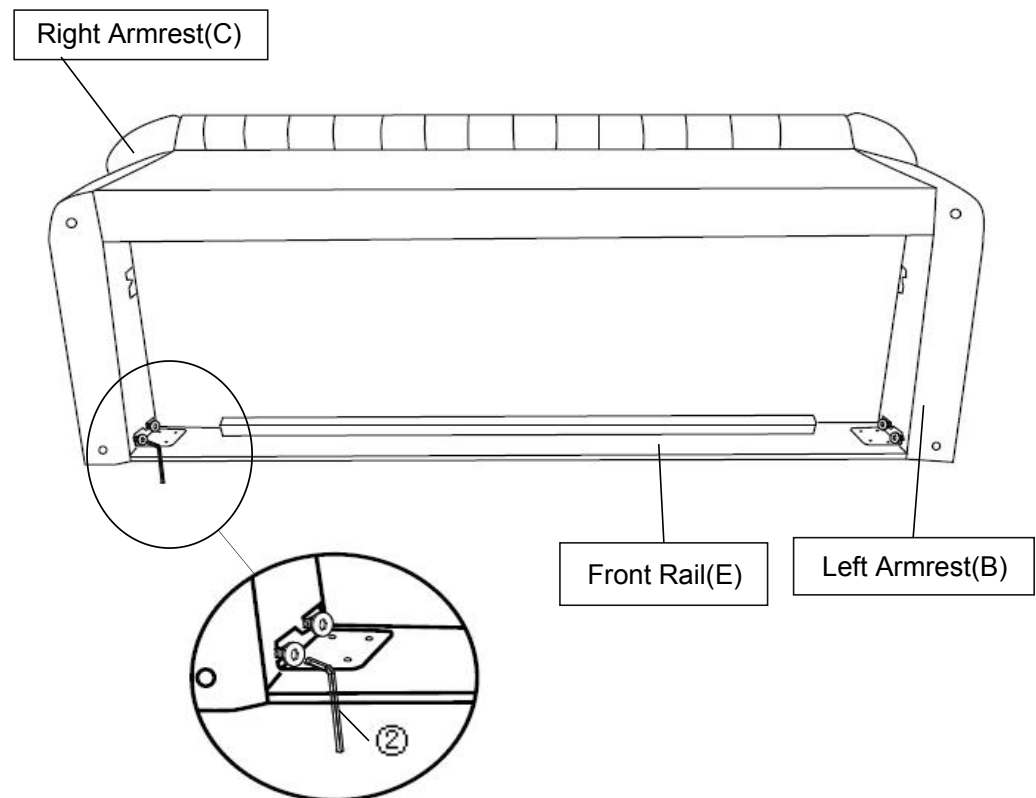

Change tilt and lay the Sofa another side onto a flat surface.  
Tighten all the Bolts at the end of bottom Left Armrest(B) and Right Armrest(C) by Allen Wrench(②) as pictured above.  
Tighten the Bolts fully in a sequential manner.

### Step 9

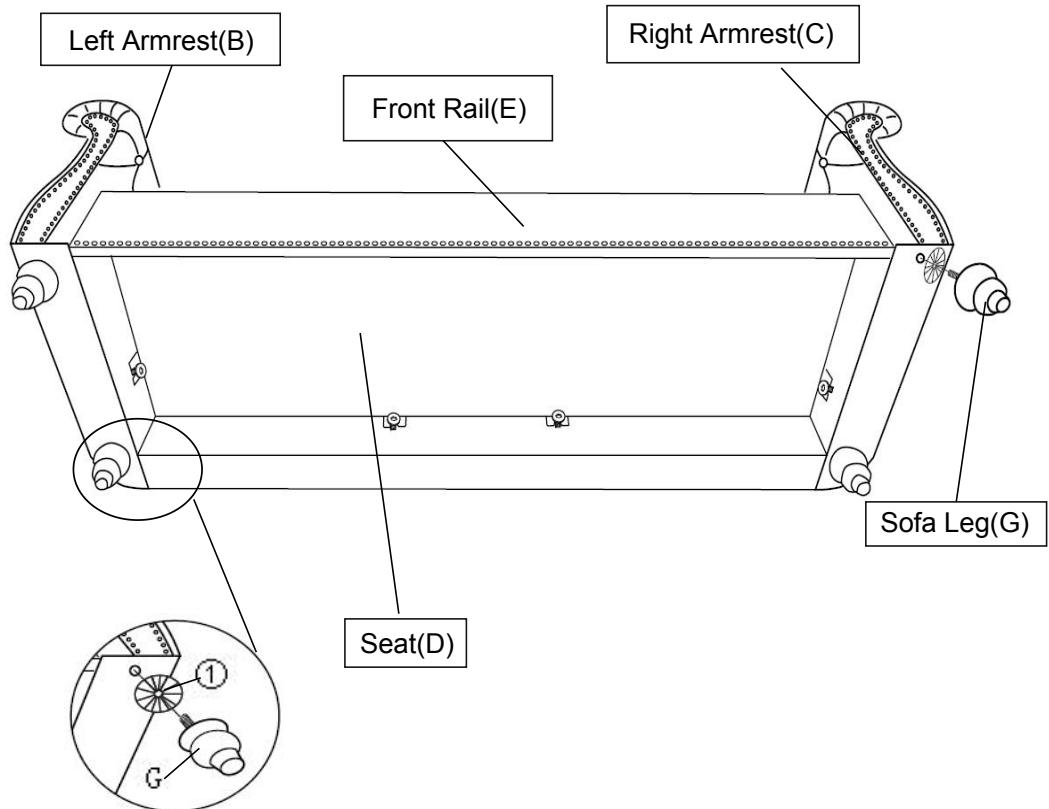

Install the Leg(G) at the bottom of Left Armrest (B) and Right Armrest(C) by placing Plastic Washer(①) on the threaded stem.  
Then insert threaded stem into the threaded mounting position at the bottom of Left Armrest(B) and Right Armrest(C).

Tighten by turning the Leg clockwise.

Note: The use of Plastic Washer(①) are OPTIONAL and are especially useful to help alleviate slight wobbles. Some Legs may need more than one whilst some legs may not need any.

Step 10

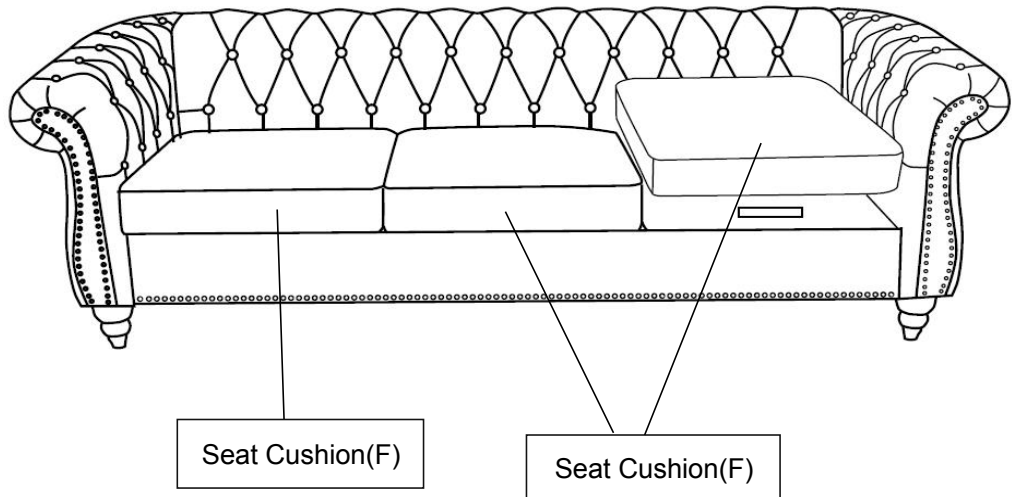

Turn the Sofa to its upright position.  
Place the Seat Cushions(F) onto the Sofa.

Step 11

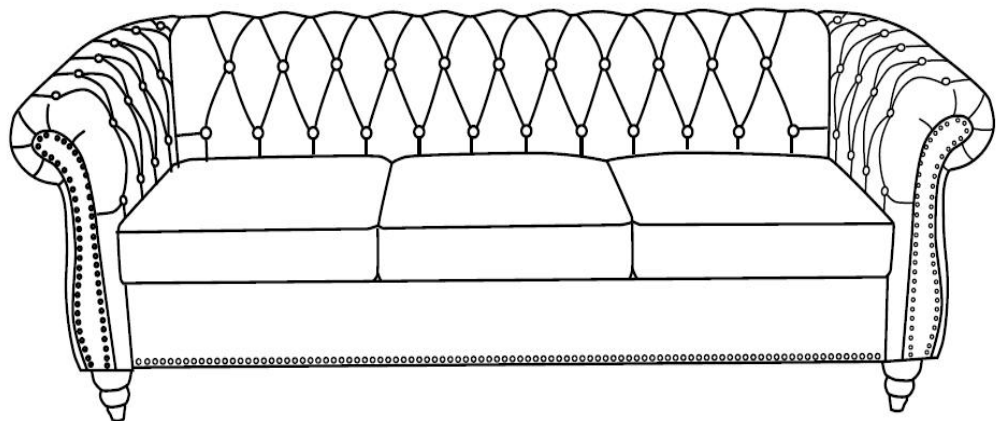

Your Sofa is ready for use.  
**This Sofa can only be used on a flat, level surface.**