

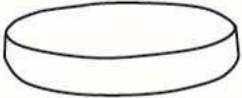

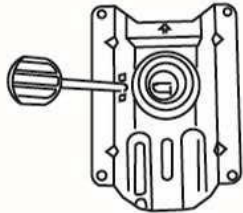



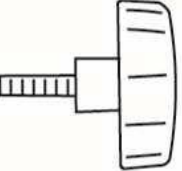

**IMPORTANT NOTICE:  
HARDWARE PACKAGE IS ATTACHED  
ON THE BOTTOM OF SEAT CUSHION.**

(1)x1  Seat Cushion	(2)x1  'Mechanism	(3)x1  Back Cushion W/ Back Support & Bellow
(4)x1  'Knob	(5)x1  / Gas Lift	(6)x1  / Base
(7)x1 	(8)x1 	(9)x5  / Casters
(A)x4 	M8X22 MECHANISM SCREW	

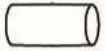

**Insert and loosely tighten all screws. When assembly is completed, fully tighten all screws before using. This chair is only intended for sitting. Any other use will void the warranty.**

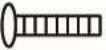
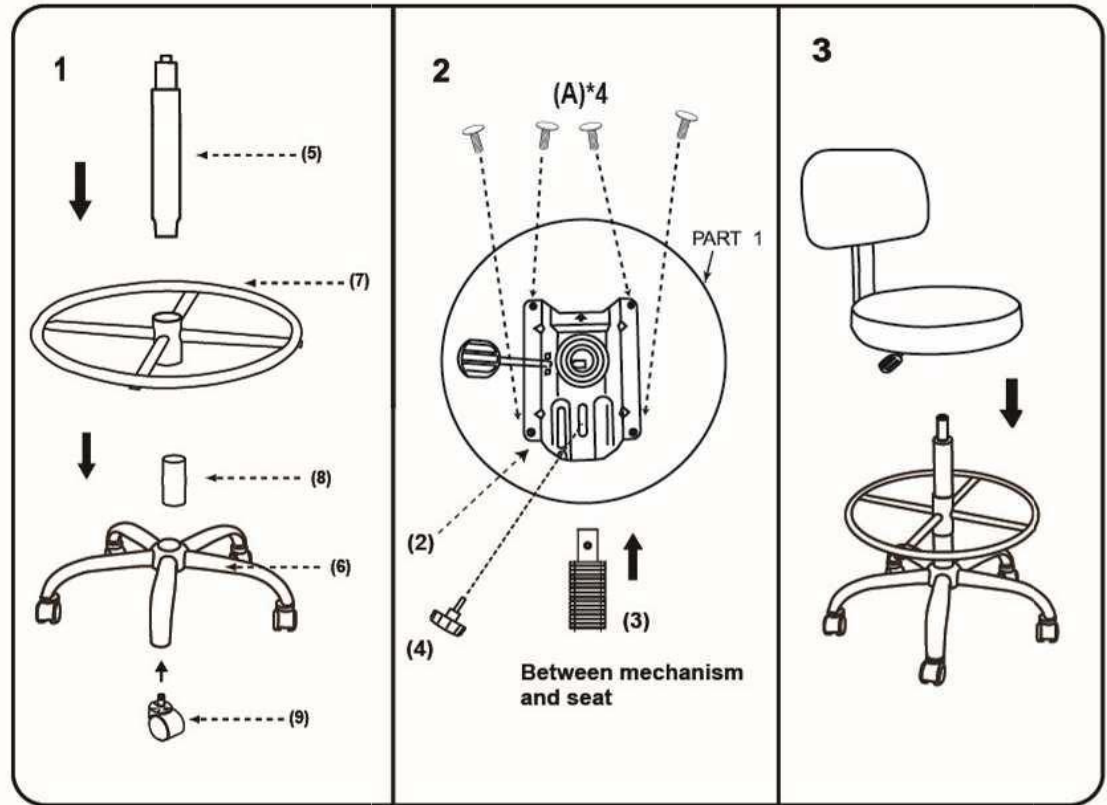