

EXPLODED VIEW

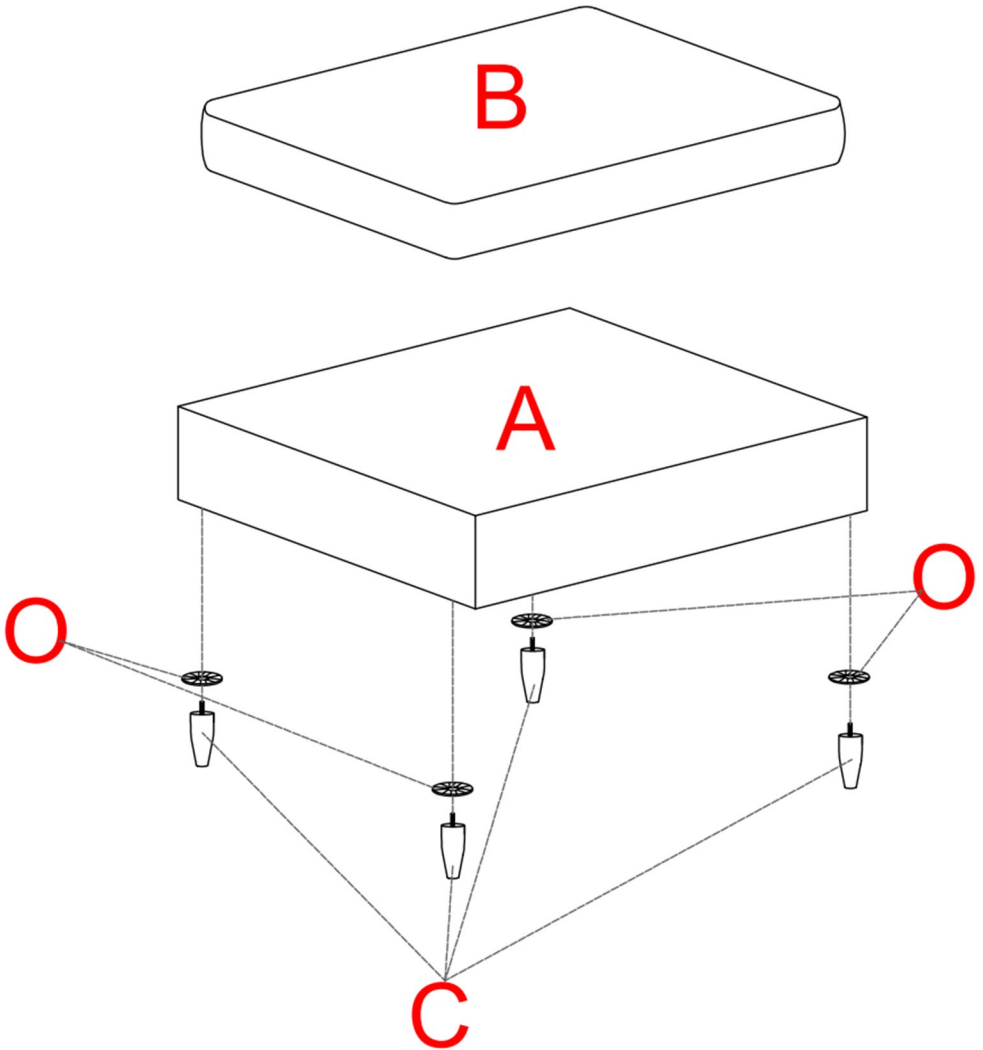

PARTS

A*1

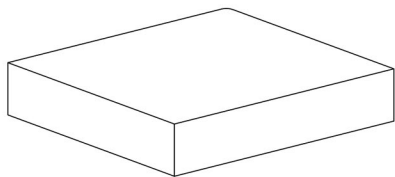

Sofe frame

B*1

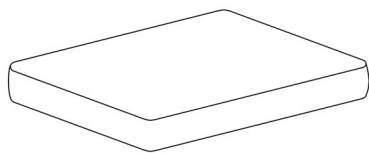

Seat cushion

HARDWARE

TOOL LIST

NOTE: Designated with (★) We provide additional spare parts in the hardware package

C*4



Legs

D*1



Metal buckle

O*4



Plastic washer

Please make sure all hardware&packing material fitting the list. Especially some small accessories may be missing during transportation. Please contact us if you have any question.

PRDOUCT DESCRIPTION

Elegant outlook, presenting a high class feeling to your living room

Corduroy fabric along with soft foam sponge, become high resilience cushions that offer you high quality relax

Firmly support solid wood legs and metal structure, giving support while long lasting

Highly customizable, simply connect them with everything we provide, and put them anywhere, anyway you want

Easy assembly, come with all the tools you need, enjoy the sofa in a moment

Dream



House

MAINTENANCE AND WARNING

Please read the manual thoroughly
before you start installing.

Please keep the product away from
sharp object.

Packaging and small parts may have
chocking hazard, please keep them away
from children and pets.

Please clean the product according to each
clean code, check the product description
for more information.

Please keep the product away from
fire.

If you have any other questions, please
contact us, we will be glad to help you out.

If the product is placed under direct
sunlight, the pattern or color might fade
away overtime.

Check the product periodically to make
sure everything is secured and tightened.

Always use proper tools for installation.

Do not jump on the product.



Around 15 min

step 1

After taking out of the cushions (B) from the air compression bag, please allow it to recover for a period of time. It might take up to 48 hours to be fully recovered, you may gently slap onto the cushion to speed up the process.

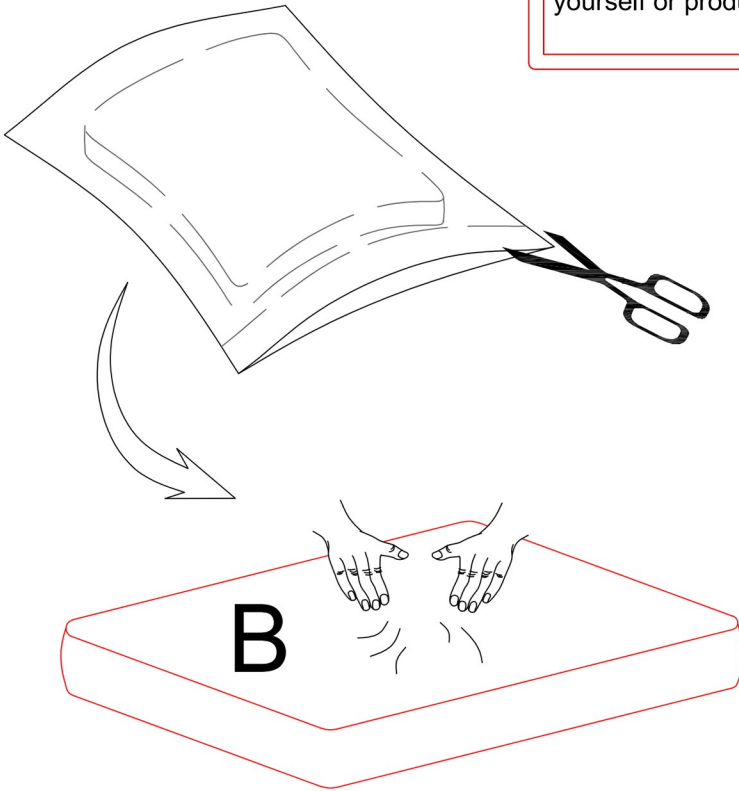

step 2

Screw the leg (C) and plastic washer (O) into each hole on seat frame (A) as shown. Make sure they are tightened.

Place the cushion (B) onto the frame (A) as shown.

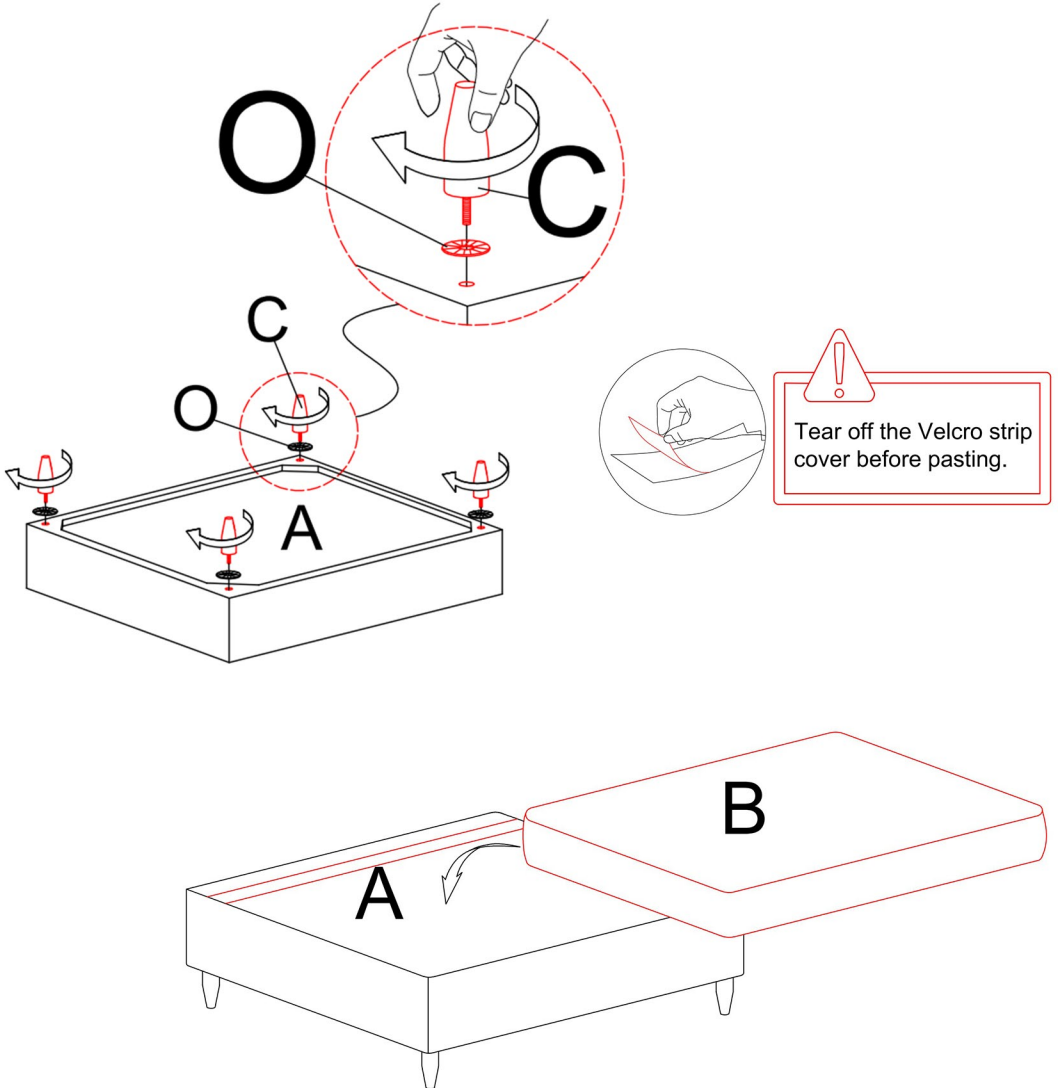

ITEM NO.CS0003-E1 OTTOMAN

WARRANTY

We strive to offer high quality product and we also try our best to satisfy each customer that order from us, no matter on products or services as needed. Each customer receives a record of their order, such as the order number or item receipt. For any items that are out of warranty period, you may still be able to purchase the replacement parts from our company if they are available.

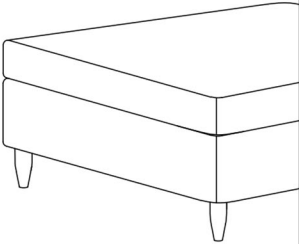

Are you having difficulty

with assembly? Missing parts?

Please contact us : info@firstopintl.com

Tel:(562)-781-3327

send an email with your order No. to us

For return, please check the return policy with the retailer or platforms you bought from.

Appreciate your purchasing from us.

Pop up your life by our furniture !

NOTICE

THE PILLOWS ARE FILLED WITH CUT SPONGE,
WHICH IS A PRODUCING TECHNIQUE.

WE PROMISE THAT ALL RAW MATERIALS
USED ARE BRAND NEW, SAFE TO USE,

AND IN ACCORDANCE WITH LAWS AND REGULATIONS,
WILL NOT EFFECT THE QUALITY AND SAFETY.

WE RECOMMEND ASK FOR PROFESSIONAL HELP IF NEEDED,
AND WE ALSO PROVIDE INSTALLATION VIDEO WITH THIS INSTRUCTIONS,
PLEASE CHECK THE STEPS CAREFULLY BEFORE YOU START.

IF YOU HAVE ANY QUESTIONS,
PLEASE FEEL FREE TO CONTACT US ANYTIME.

HAVE A GREAT DAY!



step 3

There is a metal hook inside the carton as a free part.

If you only purchased single part of the sofa, this hook will not be useful.

If you want to be combined with other sofa components (ottoman, chair, chaise etc), this hook can be used. Just use this hook to fix two parts together from the bottom to prevent displacement while using the products.

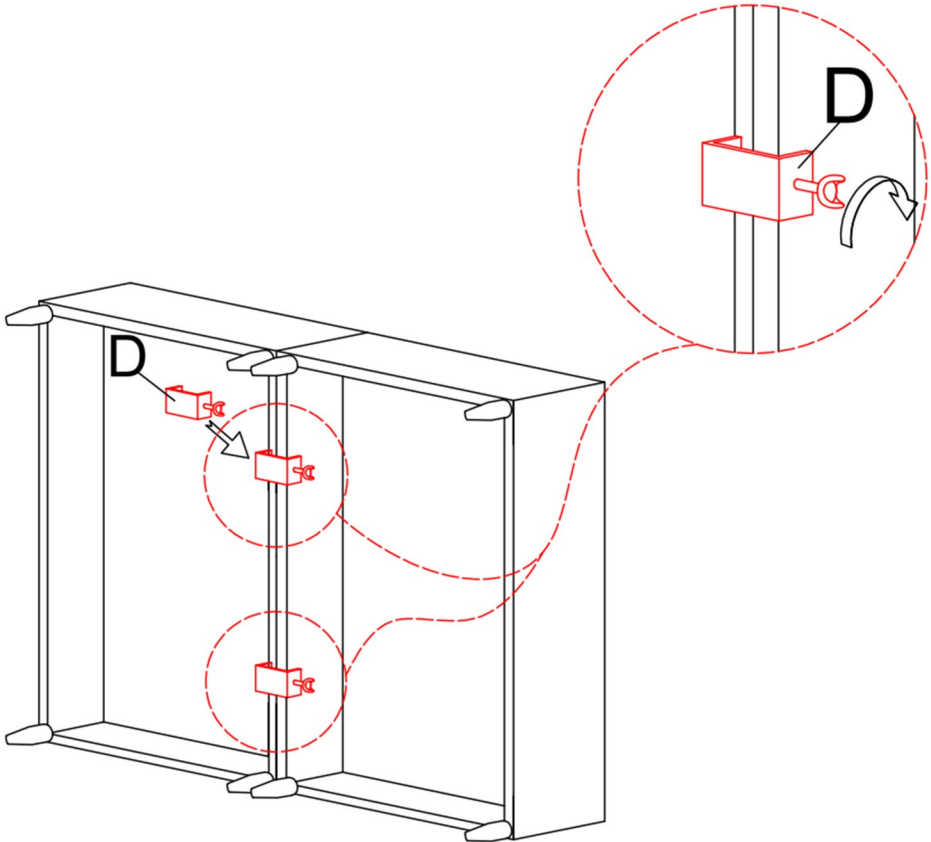



ASSEMBLY INSTRUCTIONS

Tel.(562)-781-3327

Please contact us:info@firstopintl.com

<https://www.dreamsidea.com>

DREAMS

IDEA

Instruction Manual



DREAMS/DEA

NO:CS0003-E1 OTTOMAN