

**Owner's  
Manual  
OUTDOOR  
PATIO HEATER  
STD**

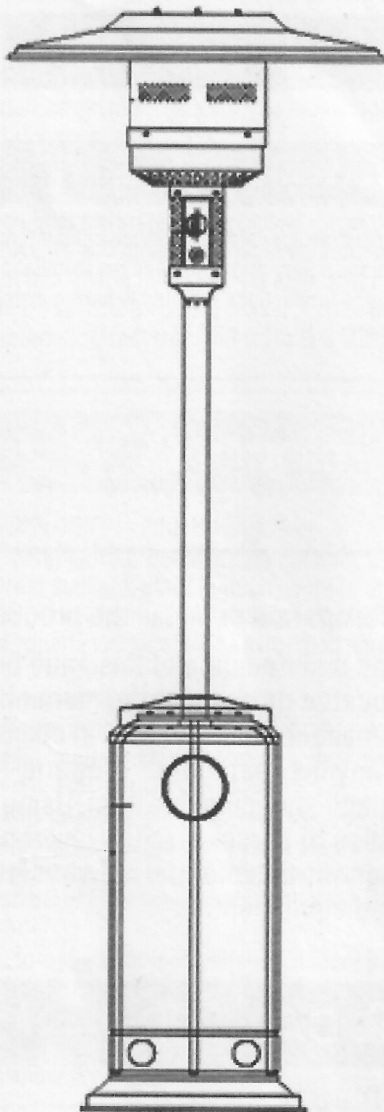

**⚠ DANGER**

**If you smell gas:**

- 1. Shut off gas to the appliance.**
- 2. Extinguish any open flame.**
- 3. If odor continues, keep away from the appliance and immediately call your gas supplier or fire department.**

**⚠ WARNING**

**Do not store or use gasoline or other flammable vapors and liquids in the vicinity of this or any other appliance. An LP-cylinder not connected for use shall not be stored in the vicinity of this or any other appliance.**

**⚠ WARNING: For Outdoor Use Only**

**⚠ DANGER**

**CARBON MONOXIDE HAZARD**

**This appliance can produce carbon monoxide which has no odor.**



**Using it in an enclosed space can kill you.**

**Never use this appliance in an enclosed space such as a camper, tent, car or home.**

**⚠ WARNING**

**Improper installation, adjustment, alteration, service or maintenance can cause property damage, injury or death. Read the installation, operation and maintenance instructions thoroughly before installing or servicing this equipment.**

**⚠ DANGER**

If you smell gas:

1. Shut off gas to the appliance.
2. Extinguish any open flame.
3. If odour continues, keep away from the appliance and immediately call your gas supplier or fire department.

**⚠ WARNING**

Do not store or use gasoline or other flammable vapours and liquids in the vicinity of this or any other appliance. An LP-cylinder not connected for use shall not be stored in the vicinity of this or any other appliance.

**⚠ WARNING: For Outdoor Use Only****⚠ DANGER****CARBON MONOXIDE HAZARD**

This appliance can produce carbon monoxide which has no odour.

Using it in an enclosed space can kill you.

Never use this appliance in an enclosed space such as a camper, tent, car or home.

**⚠ WARNING**

Improper installation, adjustment, alteration, service or maintenance can cause property damage, injury or death. Read the installation, operation and maintenance instructions thoroughly before installing or servicing this equipment.

**⚠ SAFETY INFORMATION**

Please read and understand this entire manual before attempting to assemble, operate or install the product.

This manual contains important information about the assembly, operation and maintenance of this patio heater. General safety information is presented in these first few pages and is also located throughout the manual. Keep this manual for future reference and to educate new users of this product. This manual should be read in conjunction with the labelling on the product. Safety precautions are essential when any mechanical or propane-fuelled equipment is involved. These precautions are necessary when using, storing and servicing this item. Using this equipment with the respect and caution demanded will reduce the possibilities of personal injury or property damage. The following symbols shown below are used extensively throughout this manual. Always heed these precautions, as they are essential when using any mechanical or fuelled equipment.

**⚠ DANGER**

DANGER indicates an imminently hazardous situation which, if not avoided, will result in death or serious injury.

**⚠ DANGER****FOR YOUR SAFETY**

If you smell gas:

1. Shut off gas to the appliance.
2. Extinguish any open flame.
3. If odour continues, keep away from the appliance and immediately call you gas supplier or fire department.

**⚠ DANGER**

Failure to comply with the precautions and instructions provided with this heater can result in death, serious bodily injury and property loss or damage from hazards of fire, explosion, burn, asphyxiation and/or carbon monoxide poisoning. Only persons who can understand and follow the instructions should use or service this heater.

**! DANGER**

- **EXPLOSION - FIRE HAZARD**
- Keep solid combustibles, such as building materials, paper or cardboard, a safe distance away from the heater as recommended by the instructions.
- Provide adequate clearances around air openings into the combustion chamber.
- Never use the heater in spaces which do or may contain volatile or airborne combustibles, or products such as gasoline, solvents, paint thinner, dust particles or unknown chemicals.
- During operation, this product can be a source of ignition. Keep heater area clear and free from combustible materials, gasoline, paint thinner, cleaning solvents and other flammable vapours and liquids. Do not use heater in areas with high dust content. Minimum heater clearances from combustible materials: 3 feet from the sides & 3 feet from the top.

**! DANGER**

- **EXPLOSION - FIRE HAZARD**
- Never store propane near high heat, open flames, direct sunlight, other ignition sources or where temperatures exceed 120 degrees F (49°C).
- Propane vapours are heavier than air and can accumulate in low places. If you smell gas, leave the area immediately.
- Never install or remove the propane cylinder while heater is lit, near flames, other ignition sources or while heater is hot to touch.
- This heater is red hot during use and can ignite flammables that are too close to the burner. Keep flammables at least 3 feet from sides & 3 feet from top. Keep gasoline and other flammable liquids and vapours well away from heater.
- Store the propane cylinder outdoors in a well-ventilated space out of reach of children. Never store the propane cylinder in an enclosed area (house, garage etc.). If heater is to be stored indoors, disconnect the propane cylinder for outdoor storage.

**! WARNING**

We cannot foresee every use which may be made of our heaters.  
Check with your local fire safety authority if you have questions about heater use.  
Other standards govern the use of fuel gases and heat producing products for specific uses. Your local authorities can advise you about these.  
If no local codes exist, follow National Fuel Gas Code, ANSI Z223.1. In Canada, installation must conform to local codes. If no local codes exist, follow the current National standards of CANADA CAN/CGA-B 149.2.

**! DANGER**

- **CARBON MONOXIDE HAZARD**
- This heater is a combustion appliance. All combustion appliances produce carbon monoxide (CO) during the combustion process. This product is designed to produce extremely minute, non-hazardous amounts of CO if used and maintained in accordance with all warnings and instructions. Do not block air flow into or out of the heater.
- Carbon Monoxide (CO) poisoning produces flu-like symptoms, watery eyes, headaches, dizziness, fatigue and possibly death. You can't see it and you can't smell it. It's an invisible killer. If these symptoms are present during operation of this product, get fresh air immediately!
- For outdoor use only.
- Never use inside house, or other unventilated or enclosed areas.
- This heater consumes air (oxygen). Do not use in unventilated or enclosed areas to avoid endangering your life.

**! WARNING**

WARNING indicates an imminently hazardous situation which, if not avoided, will result in death or serious injury.

**! WARNING**

Do not store or use gasoline or other flammable vapours and liquids in the vicinity of this or any other appliance. An LP-cylinder not connected for use shall not be stored in the vicinity of this or any other appliance.

**! WARNING: For Outdoor Use Only****! DANGER**

**CARBON MONOXIDE HAZARD**  
This appliance can produce carbon monoxide which has no odour. Using it in an enclosed space can kill you. Never use this appliance in an enclosed space such as a camper, tent, car or home.

**! WARNING**

Improper installation, adjustment, alteration, service or maintenance can cause property damage, injury or death. Read the installation, operation and maintenance instructions thoroughly before installing or servicing this equipment.

**! WARNING**

California Proposition 65  
Combustion by-products produced when using this product contain chemicals known to the State of California to cause cancer, birth defects and other reproductive harm.

**! WARNING****BURN HAZARD**

- Never leave heater unattended when hot or in use.
- Keep out of reach of children.

**! WARNING**

Certain materials or items, when stored under the heater, will be subjected to radiant heat and could be seriously damaged.

**! CAUTION****SERVICE SAFETY**

- Keep all connections and fittings clean. Make sure propane cylinder valve outlet is clean.
- During set up, check all connections and fittings for leaks using soapy water. Never use a flame.
- Use as a heating appliance only. Never alter in any way or use with any device.

**! CAUTION**

CAUTION indicates an imminently hazardous situation which, if not avoided, may result in minor or moderate personal injury, or property damage.

**! WARNING**

- This product is fuelled by propane gas. Propane gas is invisible, odourless and flammable. An odourant is normally added to help detect leaks and can be described as a "rotten egg" smell. The odourant can fade over time so leaking gas is not always detectable by smell alone.
- Propane gas is heavier than air and leaking propane will sink to the lowest level possible. It can ignite by ignition sources including matches, lighters, sparks or open flames of any kind many feet away from the original leak. Use only propane gas set up for vapour withdrawal.
- Store or use propane gas in compliance with local ordinances and codes or with ANS/NFPA 58. Turn off propane when not in use.

**! WARNING**

- Alert children and adults to the hazards of high surface temperatures. Stay away from these surfaces to avoid burning skin or igniting clothing.
- Carefully supervise young children when in the vicinity of the heater.
- Do not hang clothing or any other flammable materials from the heater, or place on or near the heater.
- Replace any guard or protective device removed for servicing the appliance prior to placing back in service.
- Installation and repair should be done by a qualified service person. The heater should be inspected before use and annually by a qualified service person. More frequent cleaning may be required as necessary. It is imperative that the control compartment, burners and circulating air passageway of the appliance be kept clean.

**PREPARATION**

Before beginning assembly of product, make sure all parts are present. Compare parts with package contents list and hardware contents above. If any part is missing or damaged, do not attempt to assemble the product. Contact customer service for replacement parts.

**Estimated Assembly Time: 60 minutes**

Tools Required for Assembly (not included):  
Phillips screwdriver w/ medium blade. Leak Detection Solution.

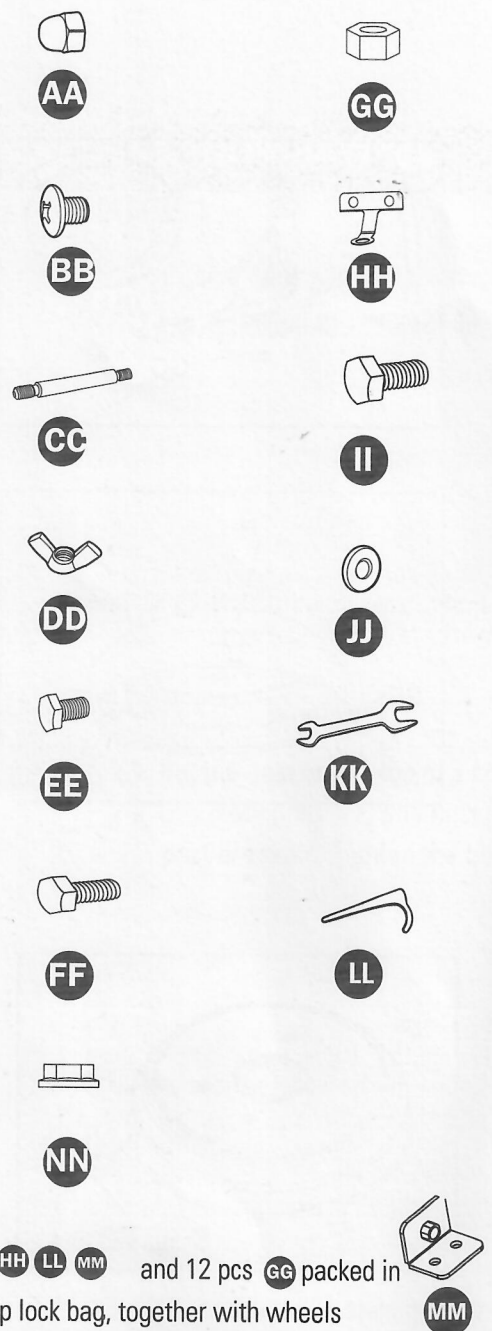

HH LL MM and 12 pcs GG packed in Zip lock bag, together with wheels MM

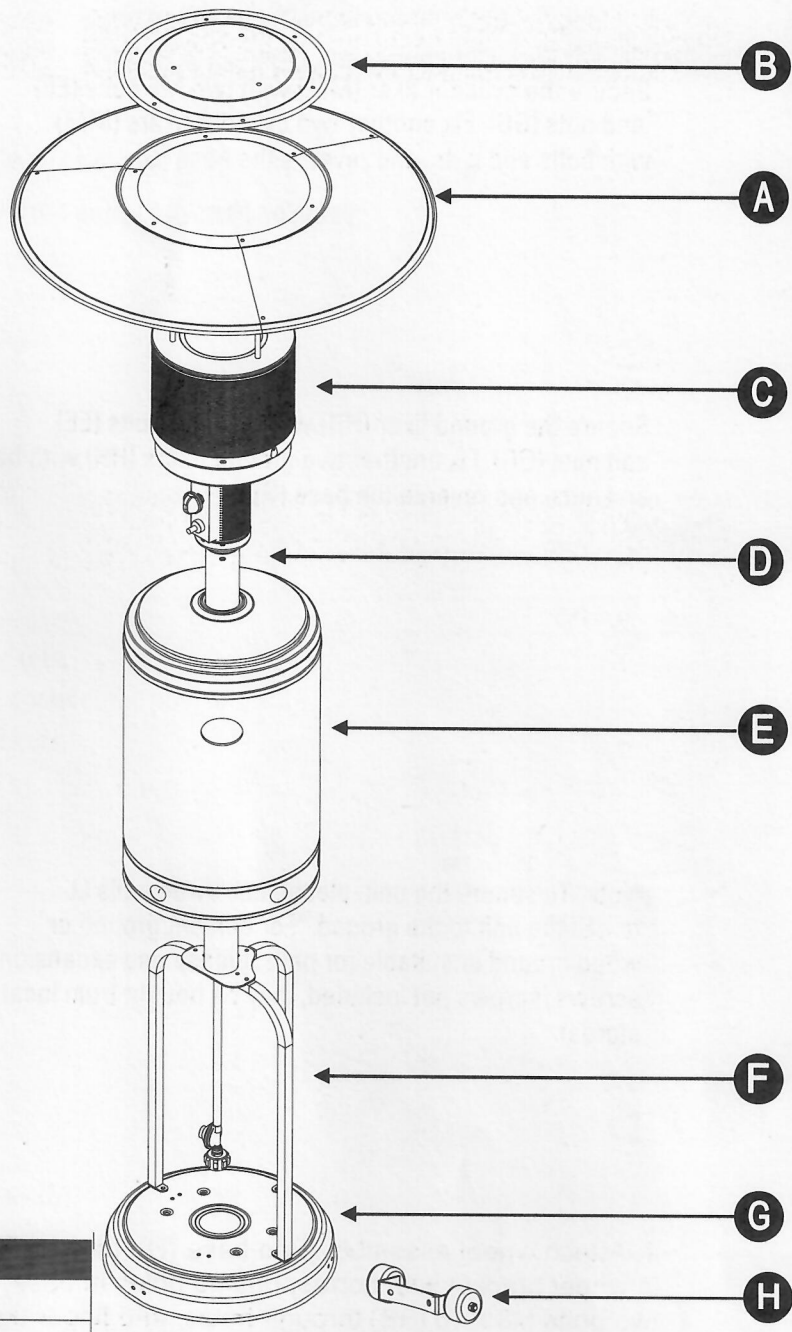

PART	DESCRIPTION	QUANTITY
AA	M6 Cap Nut	9
BB	M6*8 Bolt	9
CC	Reflector Stud	3
DD	Wing Nut	3
EE	M6*12 Bolt	12
FF	M6*30 Bolt	6
GG	M6 Nut	18
HH	Anchoring Arm	3
II	M8*15 Bolt	5
JJ	M8 Big Washer	9
KK	M6/M8 Wrench	1
LL	Anchoring	3
MM	Cylinder Fixer	3
NN	M8 Flange	2

PART	DESCRIPTION	QUANTITY	
A	Reflector	3	
B	Flame screen	1	
C	Burner	1	
D	Post	1	
E	Tank housing	1	
F	Tank housing support	3	
G	Stand	1	
H	Wheel Kit	1	For optional

Secure the cylinder fixer (MM) with two M6 bolts (EE) and nuts (GG). Fix another two cylinder fixers (MM) with bolts and nuts, and reverse the base (G).

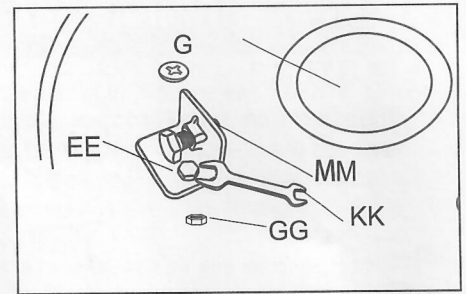

Secure the ground fixer (HH) with two M6 bolts (EE) and nuts (GG). Fix another two ground fixers (HH) with bolts and nuts, and reverse the base (G).

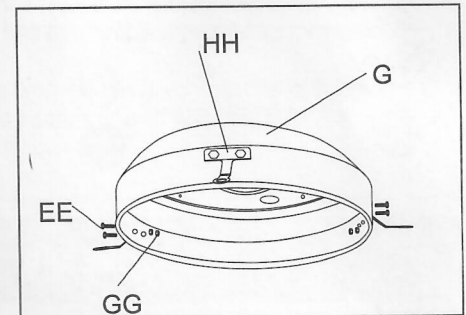

Note: To secure the unit, please use three nails LL to nail the unit to the ground. For cement ground or wood ground unsuitable for nails, please use expansion screws (screws not included, may be bought from local stores).

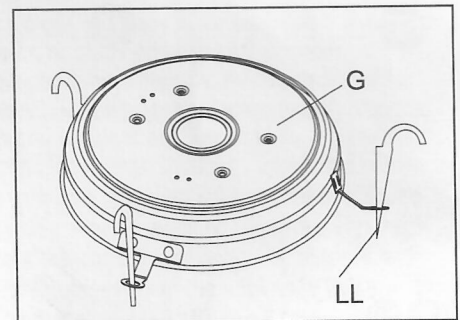

1. Attach wheel assembly (I) to base (H). Line up holes in wheel bracket with corresponding holes in base, insert two bolts M8 x 16 (BB) through holes, and finger tighten two M8 flange nuts (AA). Be sure that the wheel assembly is parallel to the base, and fully tighten bolts.

#### Hardware Used

● NN M8 Flange nut  x 2

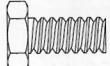
● II Bolt M8 x 16  x 2

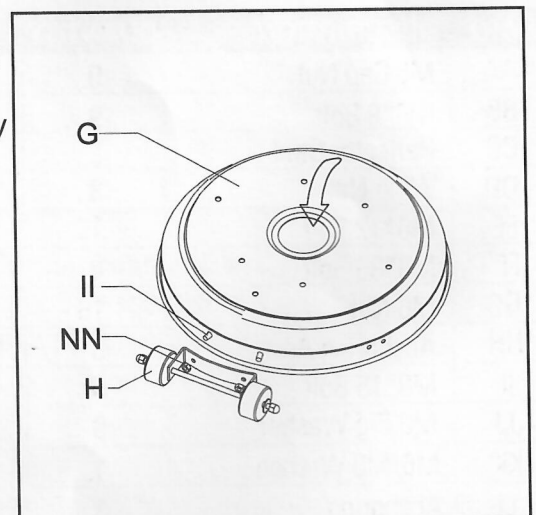

**STEP 1**

- 1-1. Position the 3 post brackets on the base as shown in the picture.
- 1-2. Use 3 bolts (M8 x 15 mm) to assemble the post, brackets and stand.

II\*3

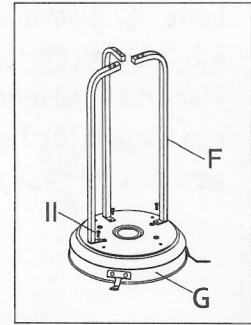
**STEP 2**

- 2-1. Put the post on the top of 3 post brackets.
- 2-2. Use 6 M6 bolts (FF) and nuts (GG) to connect the post to the 3 post brackets. Tighten the bolts and nuts.

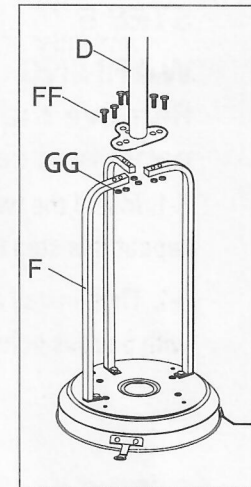
FF\*6  
GG\*6**STEP 3**

- 3-1. Place the tank housing (E) on the base (G).

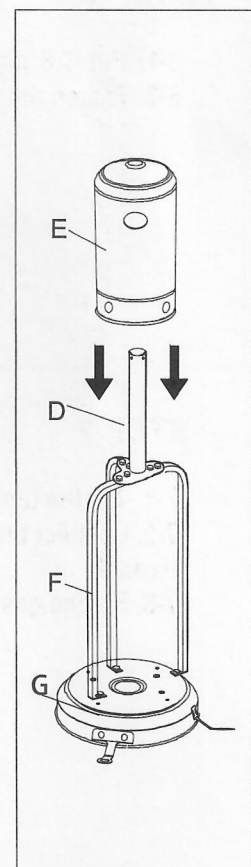

**STEP 4**

4-1. Attach a reflector stud (CC) and three washers Ø8 (JJ) to the top of the burrer (C). Tighten the reflector stud.

4-2. Unscrew the four screws that are preassembled on the head assembly (C). Place the head assembly (C) into the top of the post (D) by inserting the regulator into the post (D). Tightly fasten the previously removed screws back into the head assembly (C) through the slots at the top of the post (D).

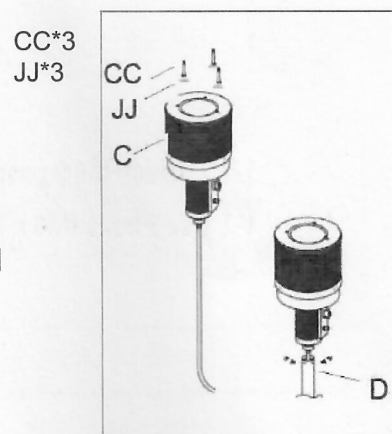
**STEP 5****WARNING**

**Remove the plastic protective coating on the reflector panel and centre the reflector before assembling!**

5-1. Install the two reflectors with 1 cross bolt M6\*8 (BB) and 1 ball nut M6 (AA), repeat this step to install the third reflector.

5-2. Then install and lock the centre disc and the newly installed reflector with 6 cross bolts M6\*8 (BB) and 6 ball nuts M6 (AA).

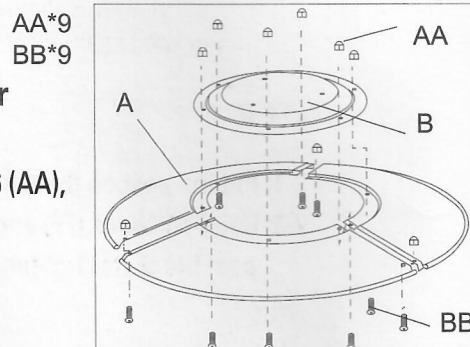
**STEP 6**

6-1. Put Ø8 mm washer (JJ) on each reflector stud (CC).

6-2. Fasten the reflector with 3 washers and 3 wing nuts (DD).

DD\*3  
JJ\*6

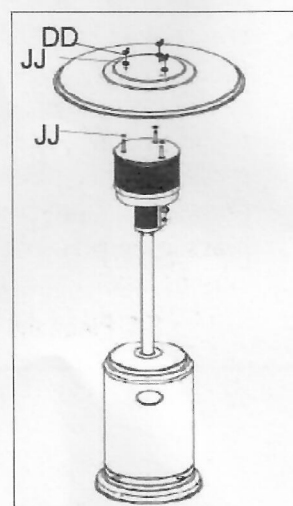
**STEP 7**

7-1. Lift the tank housing and rest it on the post plate.

7-2. Connect the regulator to the gas cylinder and tighten it with an adjustable wrench.

7-3. Put the gas cylinder on the base.

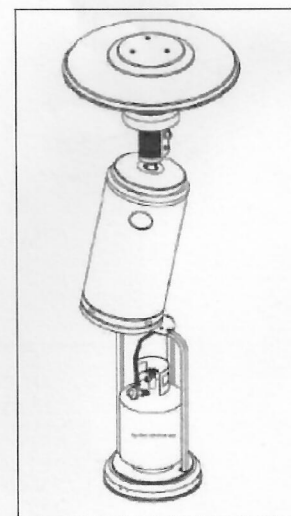

11. Screw gas hose (C) and regulator (E) onto propane 8 cylinder (not included). Do not cross-thread.

Every part of the heater should be secure against displacement and should be constructed to maintain a fixed relationship between essential parts under normal and reasonable conditions of handling and usage. Parts not permanently secured should be designed so they cannot be incorrectly assembled and cannot be improperly located or misaligned in removing or replacing during cleaning or other servicing.

**Not included.**

Use a standard 20 lb. (Not included.) propane cylinder only (approximately 12.2 in./ 31 cm. in diameter and 17.9 in. / 45.5 cm high).

Use this heater only with a propane vapour withdrawal supply system. See chapter 5 of the standard for storage and handling of liquefied petroleum gas, ANS/NFPA 58. Your local library or fire department should have this book. Storage of an appliance indoors is permissible only if the cylinder is disconnected and removed from the appliance. A cylinder must be stored outdoors in a well-ventilated area out of the reach of children. A disconnected cylinder must have dust caps tightly installed and must not be stored in a building, garage or any other enclosed area. The maximum inlet gas supply pressure: 250 psi /1750 kPa. The minimum inlet gas supply pressure: 5 psi /35 kPa. Manifold pressure with regulator provided: 11 inch W.C/ 2.74 kPa. The pressure regulator and hose assembly supplied with the appliance must be used. The installation must conform with local codes, or in the absence of local codes, with National fuel gas code, ANSI Z223.1/NFPA54, Natural gas and propane installation code, CSA B149.1, or Propane storage and handling code, B149.2.

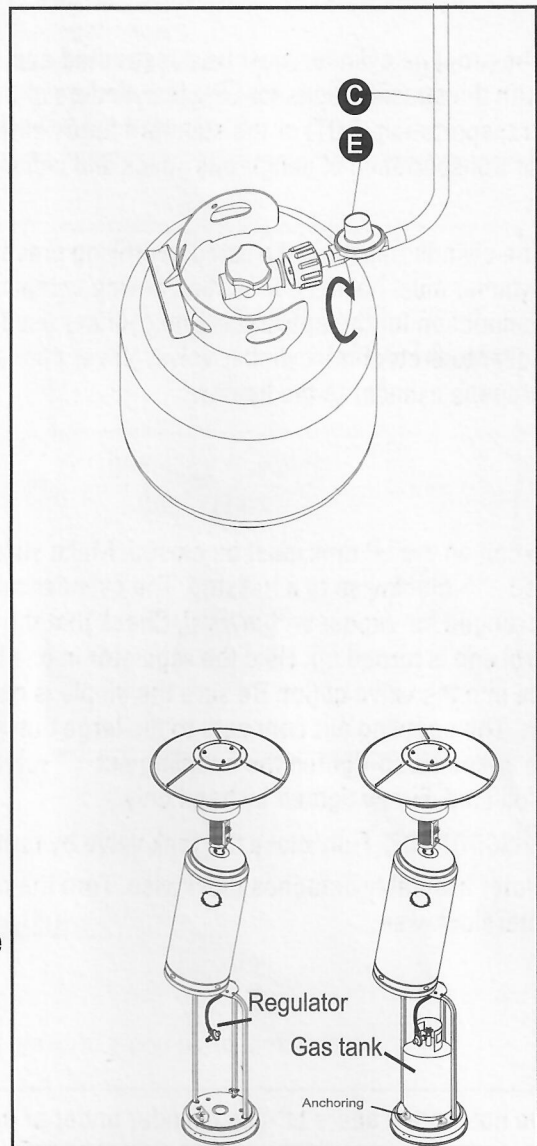

A dented, rusted or damaged propane cylinder may be hazardous and should be checked by your cylinder supplier. Never use a propane cylinder with a damaged valve connection.

The propane cylinder must be constructed and marked in accordance with the specifications for LP gas cylinders of the U.S. Department of Transportation (DOT) or the standard for cylinders, spheres and tubes for transportation of dangerous goods and commission, CAN/CSA-B339.

The cylinder must have a listed overfilling prevention device. The cylinder must have a connection device compatible with the connection for the appliance. The cylinder used must include a collar to protect the cylinder valve. Never connect an unregulated propane cylinder to the heater.

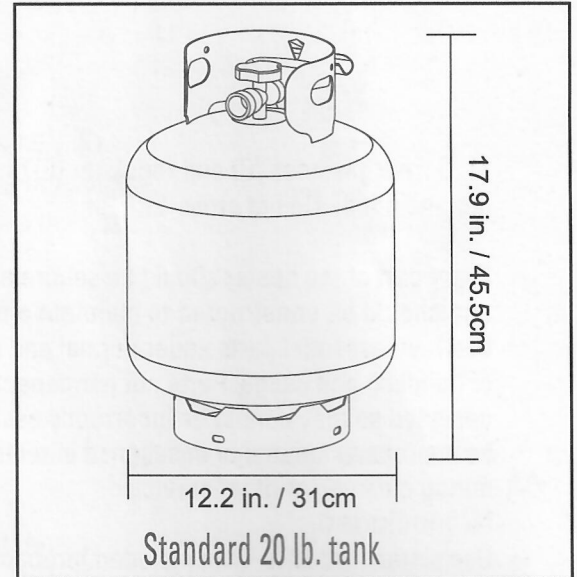

The knob on the LP tank must be closed. Make sure that the knob is turned ↻ clockwise to a full stop. The cylinder supply system must be arranged for vapour withdrawal. Check that the control knob on the control unit is turned off. Hold the regulator in one hand and insert the nipple into the valve outlet. Be sure the nipple is centred in the valve outlet. The coupling nut connects to the large outside threads on the valve outlet. Hand-tighten the coupling nut ↻ clockwise until it comes to a full stop. Firmly tighten by hand only.

**To Disconnect:** Fully close the tank valve by turning ↻ until the regulator assembly detaches clockwise. Turn the coupling nut ↻ counterclockwise.

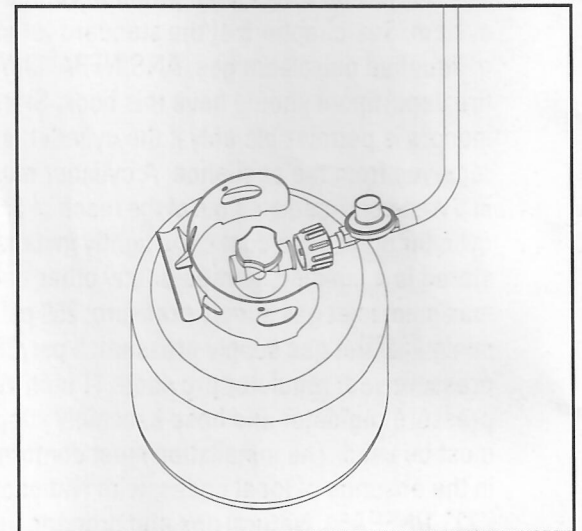

- Do not store a spare LP-gas cylinder under or near this appliance;
- Never fill the cylinder beyond 80 percent full;
- Place the dust cap on the cylinder valve outlet whenever the cylinder is not in use. Only install the type of dust cap on the cylinder valve that is provided with the cylinder valve. Other type of caps or plugs may result in leakage of propane.

**WARNING:** AA battery needed, not included. Please dispose of or recycle the batteries according to municipal requirements. Swallowed small batteries can cause **CHOKING HAZARD**. Seek immediate medical attention if batteries are swallowed or inhaled. Keep children away from the small batteries.

To check for a leak:

1. Make 2-3 oz. leak check solution (one part liquid dishwashing detergent and three parts water).
2. Apply several drops of solution where regulator connects to cylinder and to all hose and valve connections.
3. Make sure all patio heater and light valves are OFF.
4. Turn cylinder valve ON.

**If bubbles appear at any connection, there is a leak.**

1. Turn cylinder valve OFF.
2. If leak is at regulator/cylinder valve connection: Disconnect, reconnect, and perform another leak check. Apply the soapy solution to all hose and valve connections. If you continue to see bubbles after several attempts, cylinder valve is defective and should be returned to cylinder's place of purchase.
3. If leak is at hose/regulator connection: This part is defective and you should contact the customer service department for replacement.

**If NO bubbles appear at any connection, the connections are secure.**

**NOTE:** Whenever gas connections are loosened or removed, you must perform a complete leak test.

## WARNING

- Perform all leak tests outdoors.
- Extinguish all open flames.
- NEVER leak test when smoking.
- Do not use the heater until all connections have been leak tested and do not leak.

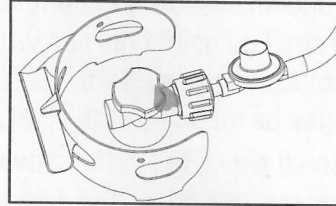

Regulator / Cylinder  
connection

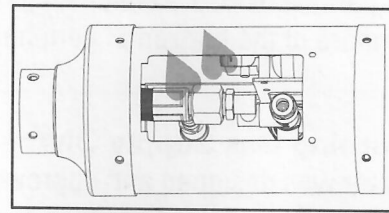

## DANGER

- CARBON MONOXIDE HAZARD
- For outdoor use only. Never use inside house, or other unventilated or enclosed areas. This heater consumes air (oxygen). Do not use in unventilated or enclosed areas to avoid endangering your life.

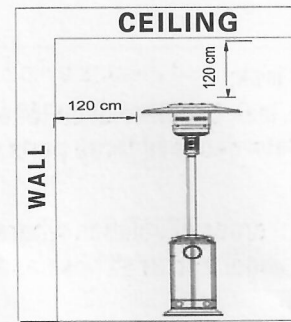

**Caution:** Do not attempt to operate until you have read and understood all General Safety Information in this manual and all assembly is complete and leak checks have been performed.

This appliance shall be used only in a well-ventilated space and shall not be used in a building, garage or any other enclosed area.

An appliance may be installed with shelter no more inclusive than:

- 1) With walls on all sides, but with no overhead cover. **Always maintain a clearance of 1.2 m (47") from combustible materials from the top and side.**
- 2) Within a partial enclosure which includes an overhead cover and no more than two side walls. These side walls may be parallel, as in a breezeway, or at right angles to each other.
- 3) Within a partial enclosure which includes an overhead cover and three side walls, as long as 30 percent or more of the horizontal periphery of the enclosure is permanently open.

### Before Turning Gas Supply ON:

1. Your heater was designed and approved for outdoor use only. Do NOT use it inside a building, garage, or any other enclosed area.
2. Make sure surrounding areas are free of combustible materials, gasoline and other flammable vapours or liquids.
3. Ensure that there is no obstruction to air ventilation. Be sure all gas connections are tight and there are no leaks.
4. Be sure the cylinder cover is clear of debris. Be sure any component removed during assembly or servicing is replaced and fastened prior to starting.

### Before Lighting:

1. Heater should be thoroughly inspected before each half year use, and by a qualified service person at least annually. If relighting a hot heater, always wait at least 5 minutes.
2. Inspect the visible portion of the hose before each use of the appliance. If the hose leaks, it must be replaced prior to operation. Only use the replacement hose assembly specified by manufacturer.
3. The pressure regulator and hose assembly supplied with the appliance must be used. Replacement pressure regulators and hose assemblies must be those specified by the appliance manufacturer.

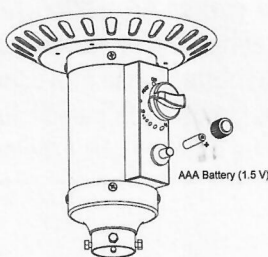

### Assembling the battery

Before use, please purchase AAA batteries by yourself, unscrew the black igniter spring cover counterclockwise, put the positive pole outward into the igniter, and screw back the black igniter spring cover.

**Lighting:**

1. Turn on the valve on the gas cylinder.
  2. Press and turn the control knob to PILOT position (anti-clockwise 90°). (Figure 1)
  3. Holding down the control knob, press the igniter button several times until the main flame is ignited. Release the control knob 10 seconds after the ignition.
  4. Press lightly and turn the variable control knob to HI (maximum) position and leave it there for 5 minutes or more before turning the knob to the desired temperature setting. (Figure 2)
  5. If the burner flame goes out, turn off the heater and wait at least 5 minutes or more to let the gas dissipate before re-lighting to avoid gas explosion.
- Repeat steps 2 to 4.

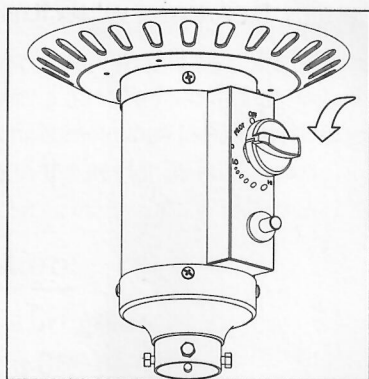

Figure 1

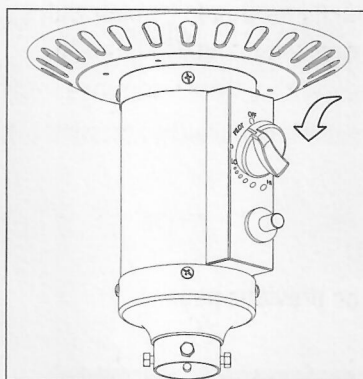
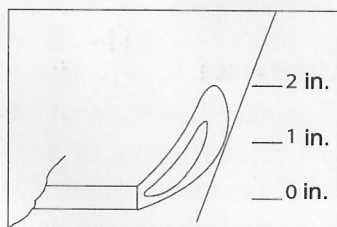

Figure 2

**Note:** Improper operation can cause injury or property damage. If pilot fails to remain lit, all valves should be closed and you should wait for at least 5 minutes before attempting to light it again. If you experience any ignition problem, please consult "Troubleshooting" on page 17.

**Caution:** Avoid inhaling fumes emitted from the heater's first use. Smoke and odour from the burning of oils used in manufacturing will appear. Both smoke and odour will dissipate after approximately 30 minutes. The heater should NOT produce thick black smoke.

**Note:** The burner may be noisy when initially turned on. Turn the knob to the level of heat desired.



Normal

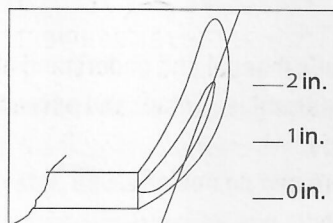

Abnormal

**WARNING****FOR YOUR SAFETY**

Be careful when attempting to manually ignite this heater. Holding in the control knob for more than 10 seconds before igniting the gas will cause a ball of flame upon ignition.

**When Heater is ON:**

Emitter screen will become bright red due to intense heat. The colour is more visible at night. Burner will display tongues of blue and yellow flame. These flames should not be yellow or produce thick black smoke, indicating an obstruction of airflow through the burners. The flame should be blue with straight yellow tops. If excessive yellow flame is detected, turn off heater and consult "Troubleshooting" on page 16.

**Re-lighting:**

1. Turn control knob to OFF.
2. Repeat the "Lighting" steps on previous page.

**WARNING****FOR YOUR SAFETY**

Heater will be hot after use. Handle with extreme care.

**Shut Down:**

Turn cylinder valve clockwise to OFF and disconnect regulator when heater is not in use.

**Note:** After use, some discolouration of the emitter screen is normal.

**Operation Checklist**

For a safe and pleasurable heating experience, perform this check before each use.

**Before Operating:**

1. I am familiar with entire owner's manual and understand all precautions noted.
2. All components are properly assembled, intact and operable.
3. No alterations have been made.
4. All gas connections are secure and do not leak.
5. Wind velocity is below 10 mph.
6. Unit will operate at reduced efficiency below 40°F.
7. Heater is outdoors (outside any enclosure).
8. There is adequate fresh air ventilation.

9. Heater is away from gasoline or other flammable liquids or vapours.
10. Heater is away from windows, air intake openings, sprinklers and other water sources.
11. Heater is at least 2.3 feet on top and at least 3.3 feet on sides from combustible materials.
12. Heater is on a hard and level surface.
13. There are no signs of spider or insect nests.
14. All burner passages are clear.
15. All air circulation passages are clear.
16. Children and adults should be alerted to the hazards of high surface temperatures and should stay away to avoid burns or clothing ignition.
17. Young children should be carefully supervised when they are in the area of the heater.
18. Clothing or other protective material should not be hung from the heater, or placed on or near the heater.
19. Any guard or other protective device removed for servicing the heater must be replaced prior to operating the heater.
20. Installation and repair should be done by a qualified service person. The heater should be inspected before use and at least annually by a qualified service person.
21. More frequent cleaning may be required as necessary. It is imperative that control compartment, burner and circulating air passageways of the heater be kept clean.

### **After Operation**

1. Gas control is in OFF position.
2. Gas tank valve is OFF.
3. Disconnect gas line.

## **CARE AND MAINTENANCE**

---



### **WARNING**

#### **FOR YOUR SAFETY:**

- Do NOT touch or move heater for at least 45 minutes after use.
- Reflector is hot to the touch.
- Allow reflector to cool before touching.

To enjoy years of outstanding performance from your heater, make sure you perform the following maintenance activities on a regular basis:

Keep exterior surfaces clean.

1. Use warm soapy water for cleaning. Never use flammable or corrosive cleaning agents.
2. While cleaning your unit, be sure to keep the area around the burner assembly dry at all times. Do not submerge the control valve assembly. If the gas control is submerged in water, do NOT use it. It must be replaced.
  - a. Keep the appliance area clear and free from combustible materials, gasoline and other flammable vapours and liquids.
  - b. Do not obstruct the flow of combustion and air ventilation.
  - c. Keep the ventilation opening(s) of the cylinder enclosure free and clear from debris.
3. Air flow must be unobstructed. Keep controls, burner, and circulating air passageways clean.

Visually check portions of the hose assembly located within the confines of the heater post. Inspect the entire hose assembly at least annually, disassembling the reflector and burner. Inspect the hose assembly for evidence of excessive abrasion, cuts, or wear. Suspected areas should be leak tested. Then assembling the reflector and burner again following with step 6 and 7.

- Gas odour with extreme yellow tipping of flame.
- Heater does NOT reach the desired temperature.
- Heater glow is excessively uneven.
- Heater makes popping noises.
- Spiders and insects can nest in burners or orifices. This dangerous condition can damage the heater and render it unsafe for use. Clean burner holes by using a heavy-duty pipe cleaner. Compressed air may help clear away smaller particles.
- Carbon deposits may create a fire hazard. Clean dome and burner screen with warm soapy water if any carbon deposits develop.

Note: In a salt-air environment (such as near an ocean), corrosion occurs more quickly than normal. Frequently check for corroded areas and repair them promptly.

**TIP:**

Use high-quality automobile wax to help maintain the appearance of your heater. Apply to exterior surfaces from the pole down. Do not apply to emitter screen or domes.

### Storage

Between uses:

- Turn control knob OFF.
- Disconnect LP source.
- Store heater upright in an area sheltered from direct contact with inclement weather (such as rain, sleet, hail, snow, dust and debris).
- If desired, cover heater to protect exterior surfaces and to help prevent build-up in air passages.

Note: Wait until heater is cool before covering.

### During periods of extended inactivity or when transporting:

- Turn control knob OFF.
- Disconnect LP source and move to a secure, well-ventilated location outdoors.
- Store heater upright in an area sheltered from direct contact with inclement weather (such as rain, sleet, hail, snow, dust and debris).
- If desired, cover heater to protect exterior surfaces and to help prevent build-up in air passages.

Never leave LP cylinder exposed to direct sunlight or excessive heat.

Note: Wait until heater is cool before covering.

### Service

Only a qualified service person should repair gas passages and associated components.

Caution: Always allow heater to cool before attempting service.

PROBLEM	POSSIBLE CAUSE	CORRECTIVE ACTION
Burner won't light	Propane cylinder is frosted over	Wait until the propane cylinder warms up and is defrosted
	Blockage in orifice	Clear blockage
	Control knob is not in ON position	Turn control knob to ON
Burner flame is low	Gas pressure is low	Turn cylinder valve OFF and replace cylinder
	Outdoor temperature is less than 40°F and tank is less than 1/4 full	Use a full cylinder
	Control knob fully ON	Check burner and orifices for blockage
Carbon build-up	Dirt or film on reflector and burner screen	Clean reflector and burner screen
Thick black smoke	Blockage in burner	Remove blockage and clean burner inside and outside

This product is inspected, tested and carefully packaged to minimize the chance of damage during shipment. If a part within one year from the date of purchase proves to be defective in material or fabrication under normal use, the part will be repaired or replaced. The Company's obligation under the warranty is to replace or repair defective parts at our discretion. Any expenses or damage resulting from the installation, removal or transportation of the product will be the responsibility of the owner and are not covered by this warranty. The owner assumes all other risks arising out from the use or misuse of the product. The warranty will be void if the product damage or failure is deemed by the Company to be caused by accident, alteration, misuse, abuse, incorrect installation or removal, or connection to an incorrect power source by the owner. The Company neither assumes, nor authorizes any person or entity to assume for it any obligation or liability associated with its products.

This For Living product carries a one (1) year warranty against defects in workmanship and materials. Trileaf Distribution agrees to replace the defective product free of charge within the stated warranty period, when returned by the original purchaser with proof of purchase. This product is not guaranteed against wear or breakage due to misuse and/or abuse.