

Variante 1

Variante 2

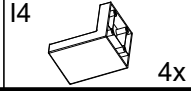

1

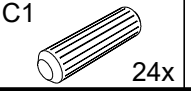
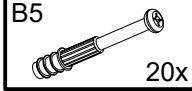
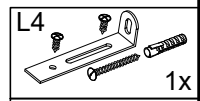
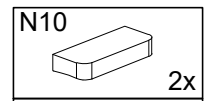
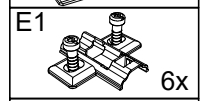
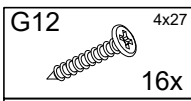
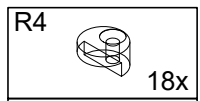
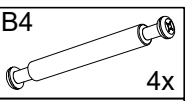
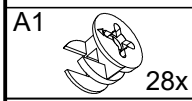
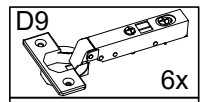
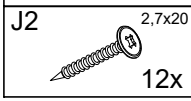
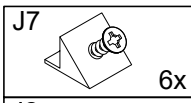
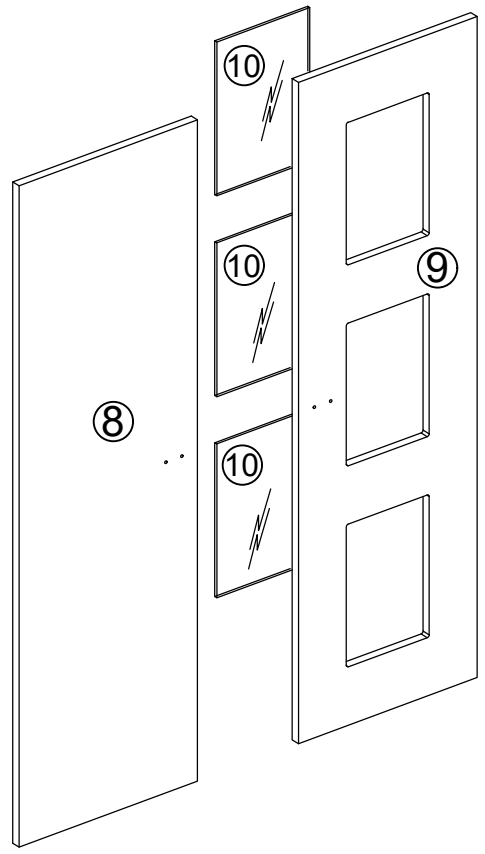
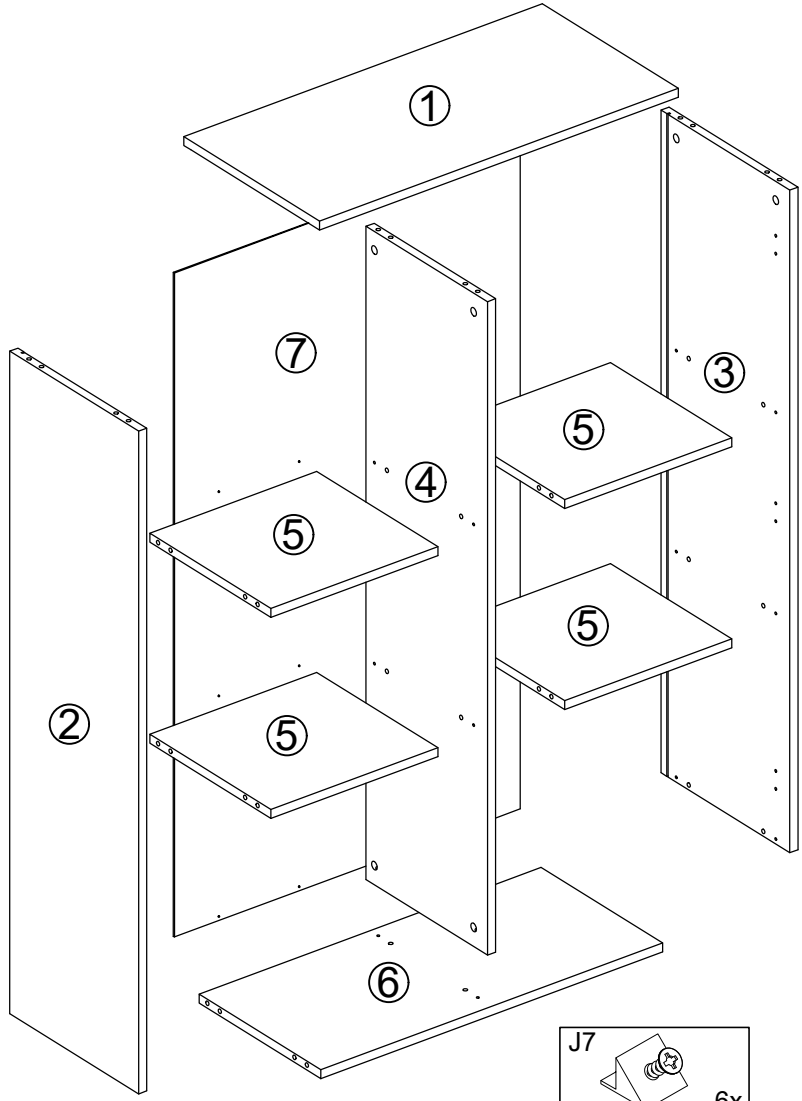
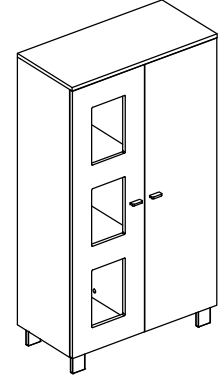
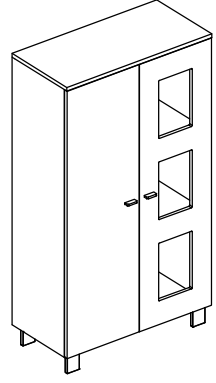
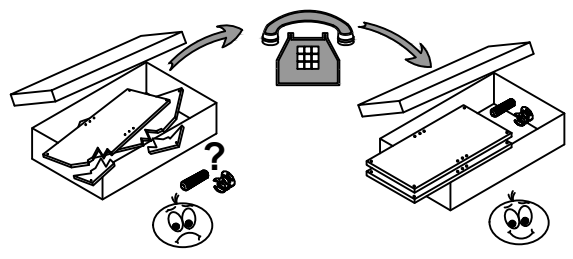
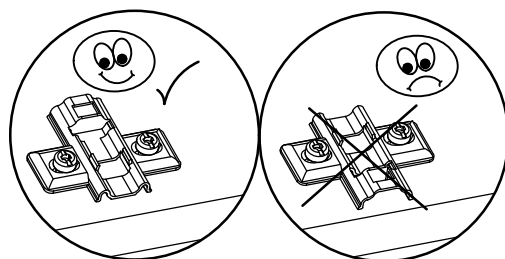
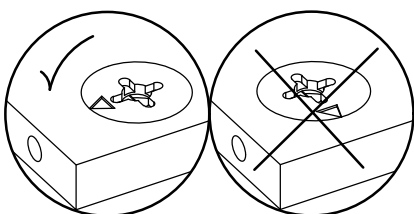
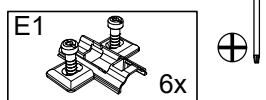
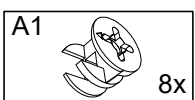
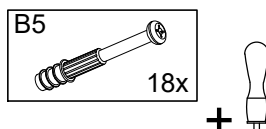
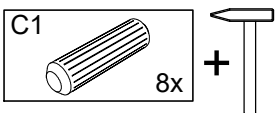
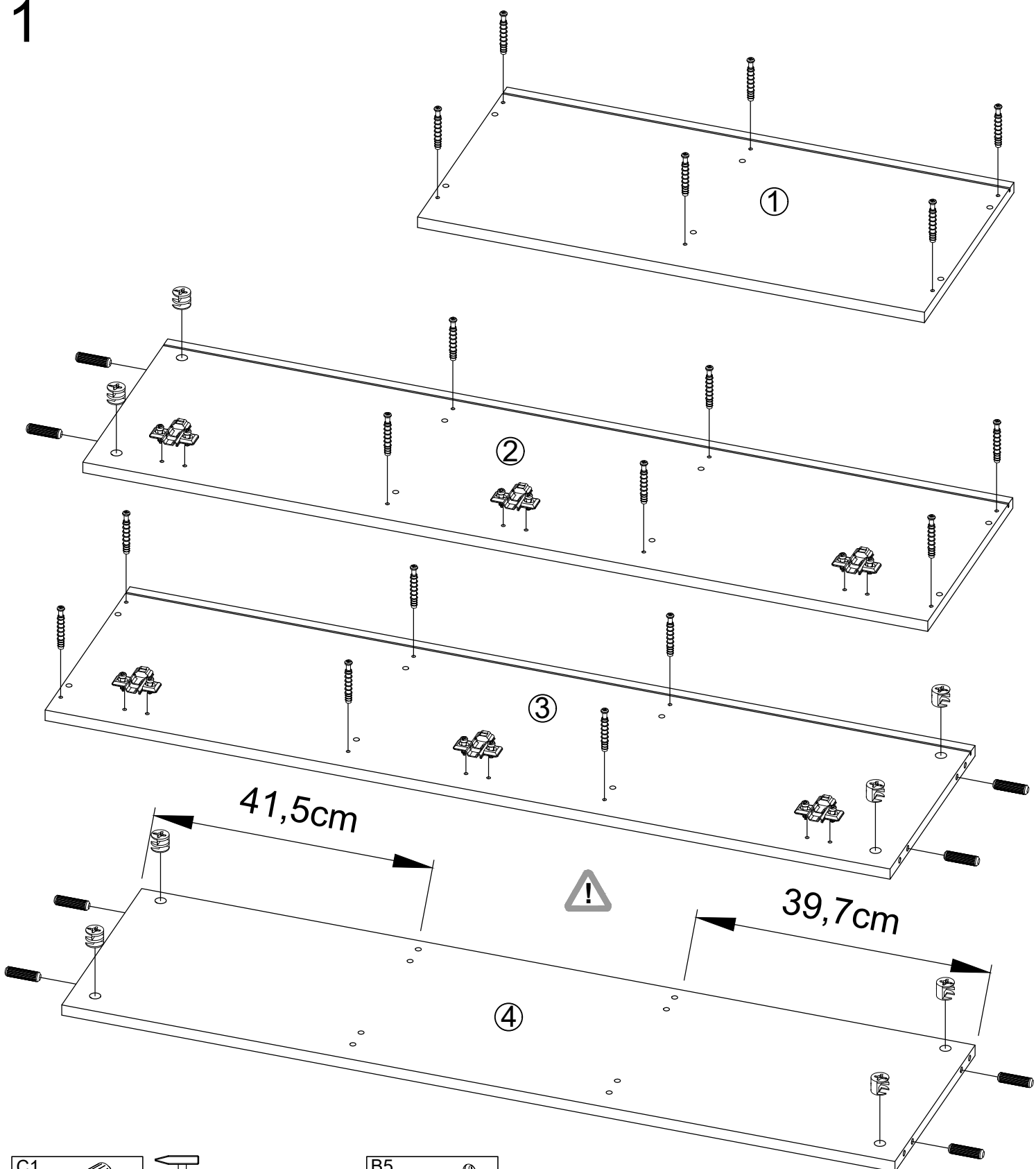

2

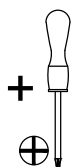
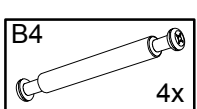
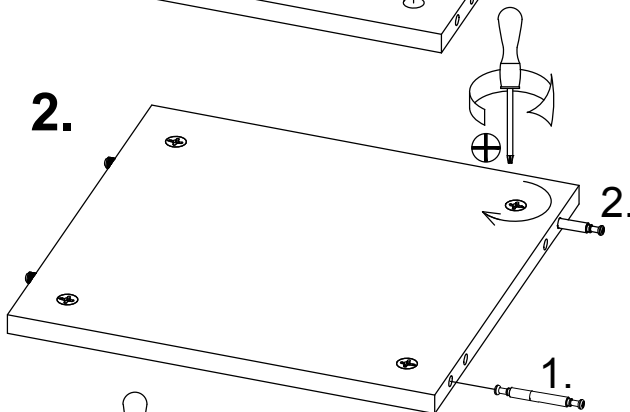
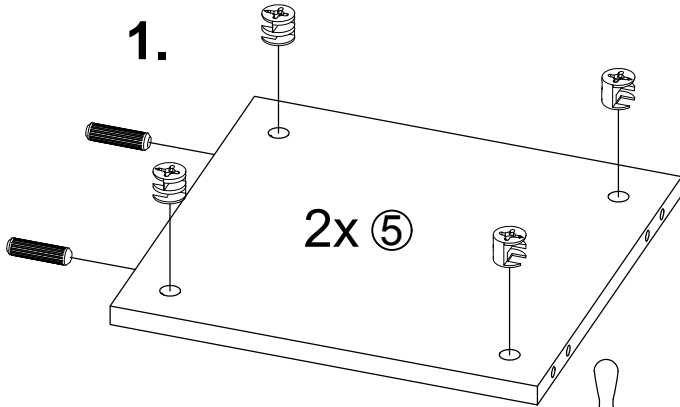
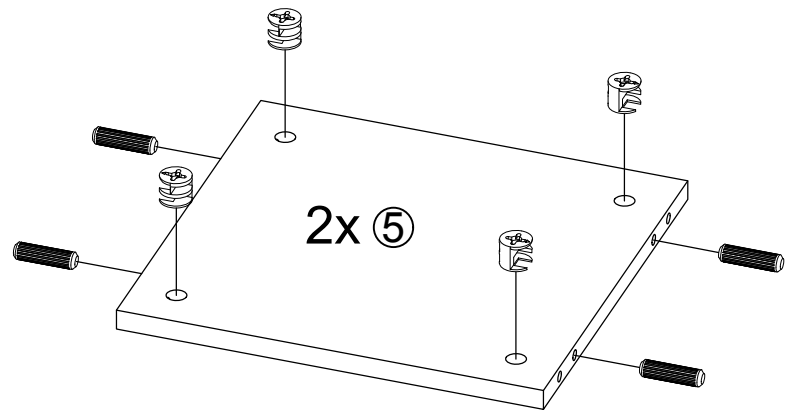
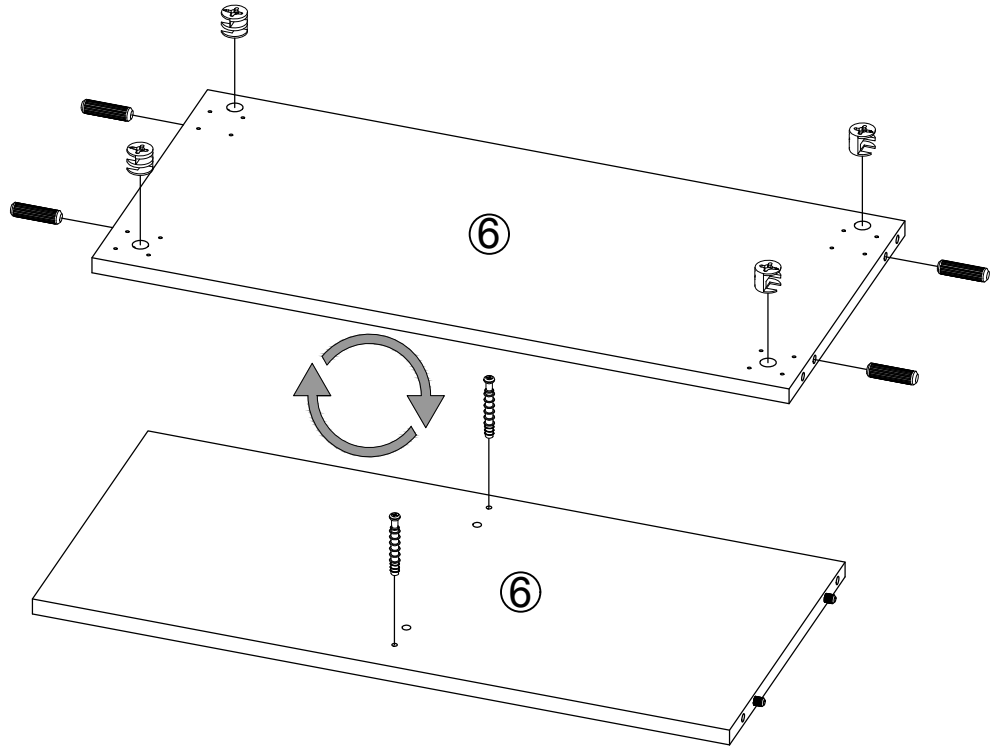
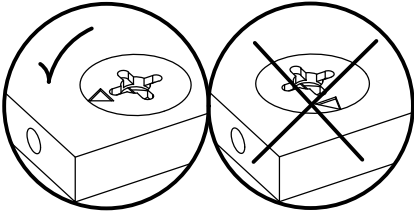
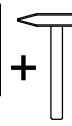
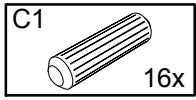
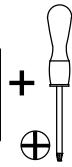
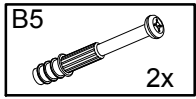

3

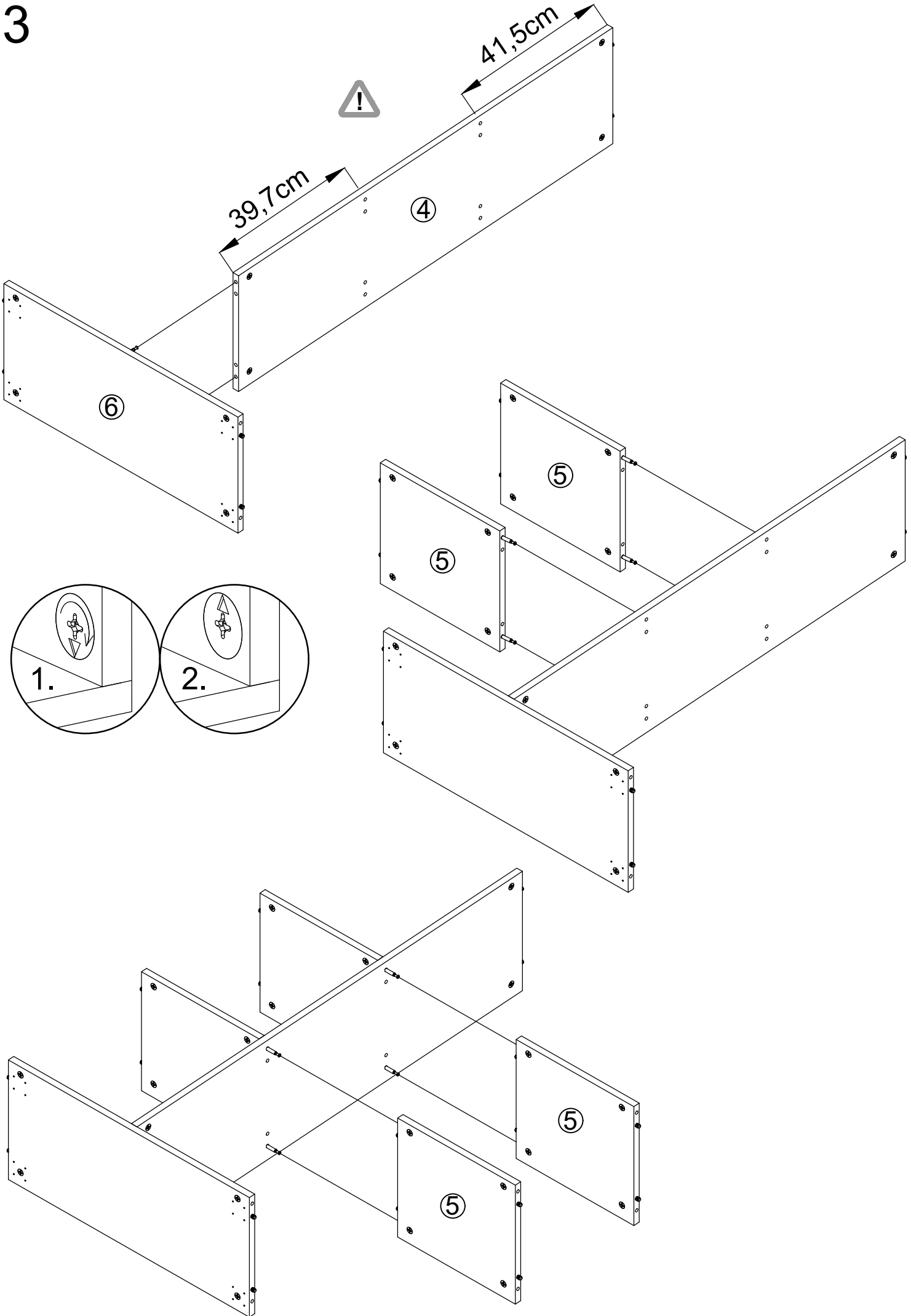

4

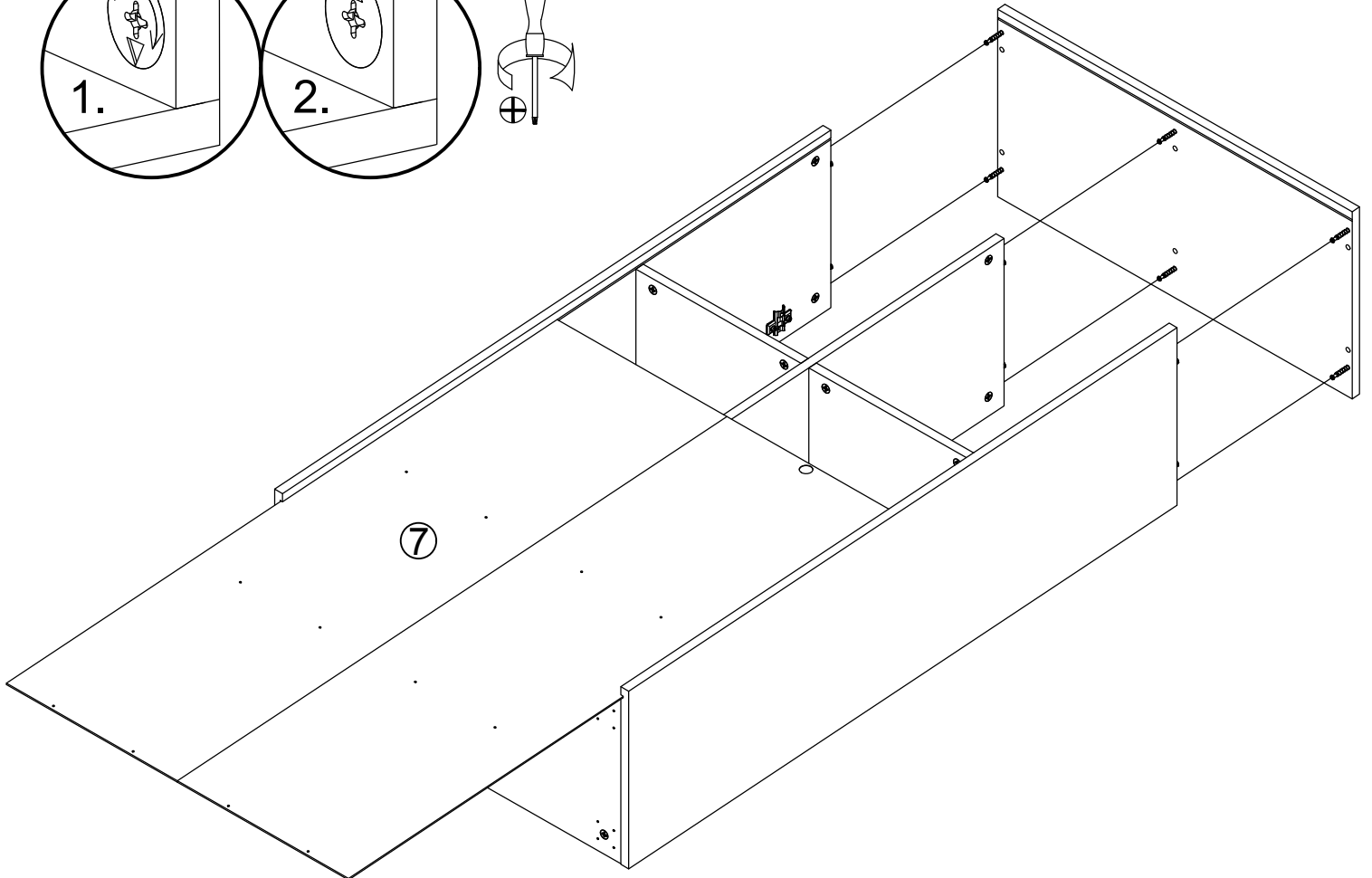
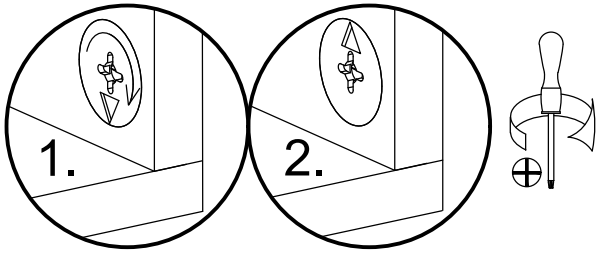
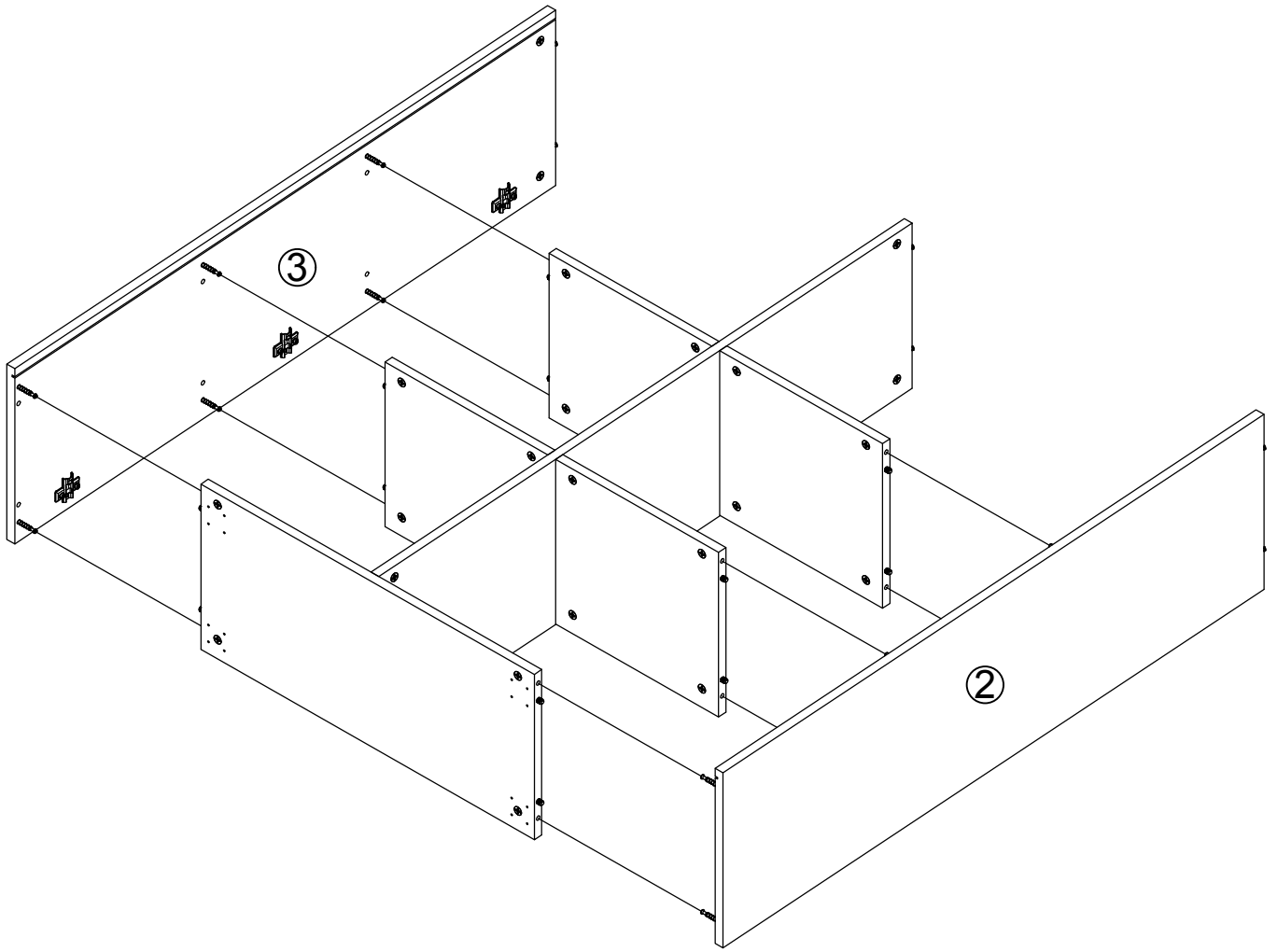

5

- J2 2,7x20 12x
- J7 6x

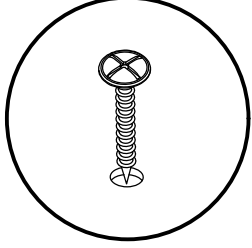
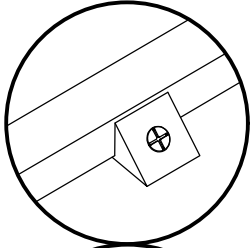
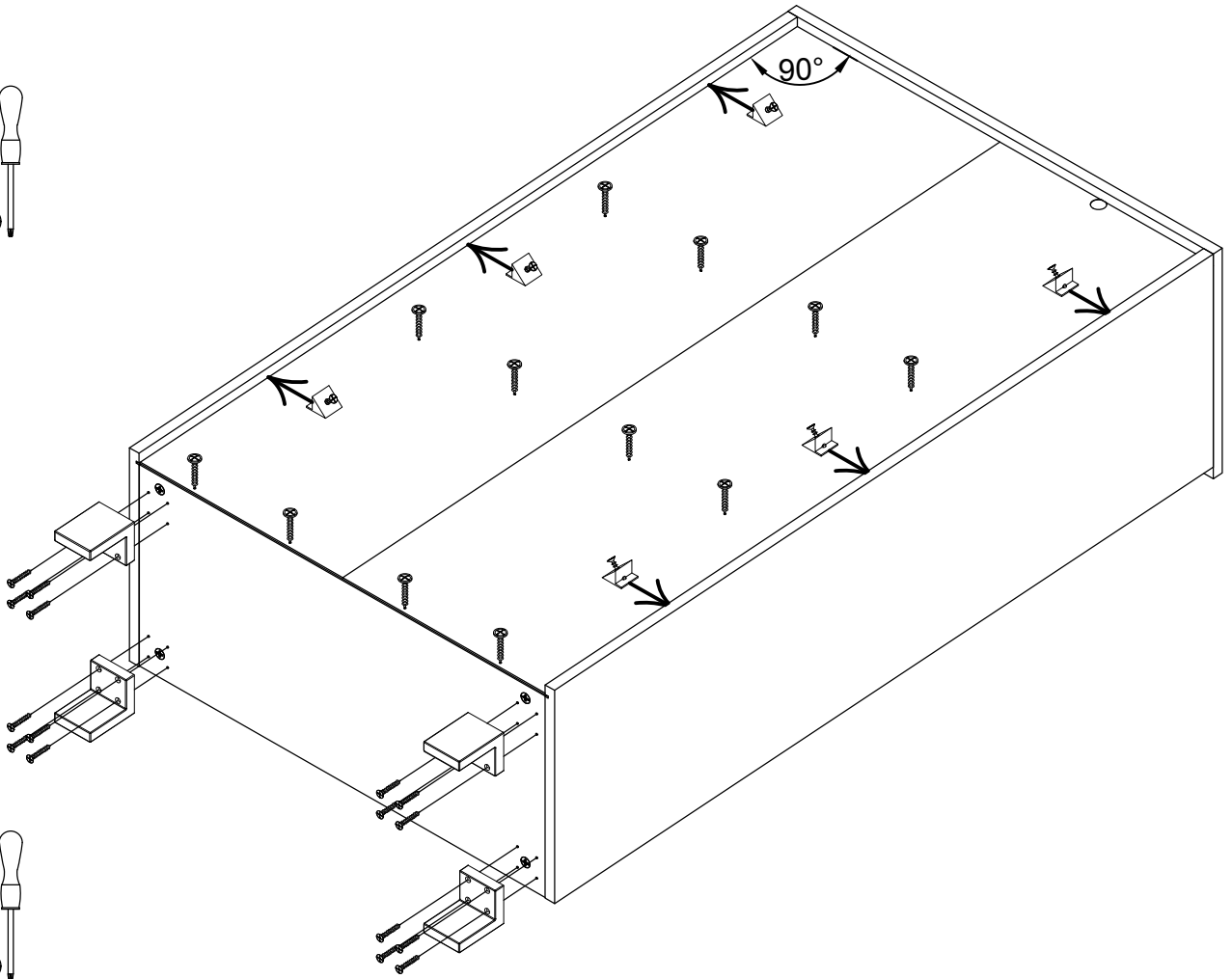
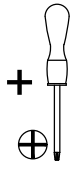

- G12 4x27 16x
- I4 4x

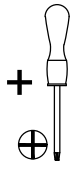

6

- D9 6x
- G1 4x15 12x

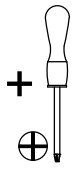

- R4 18x
- G9 3x20 18x

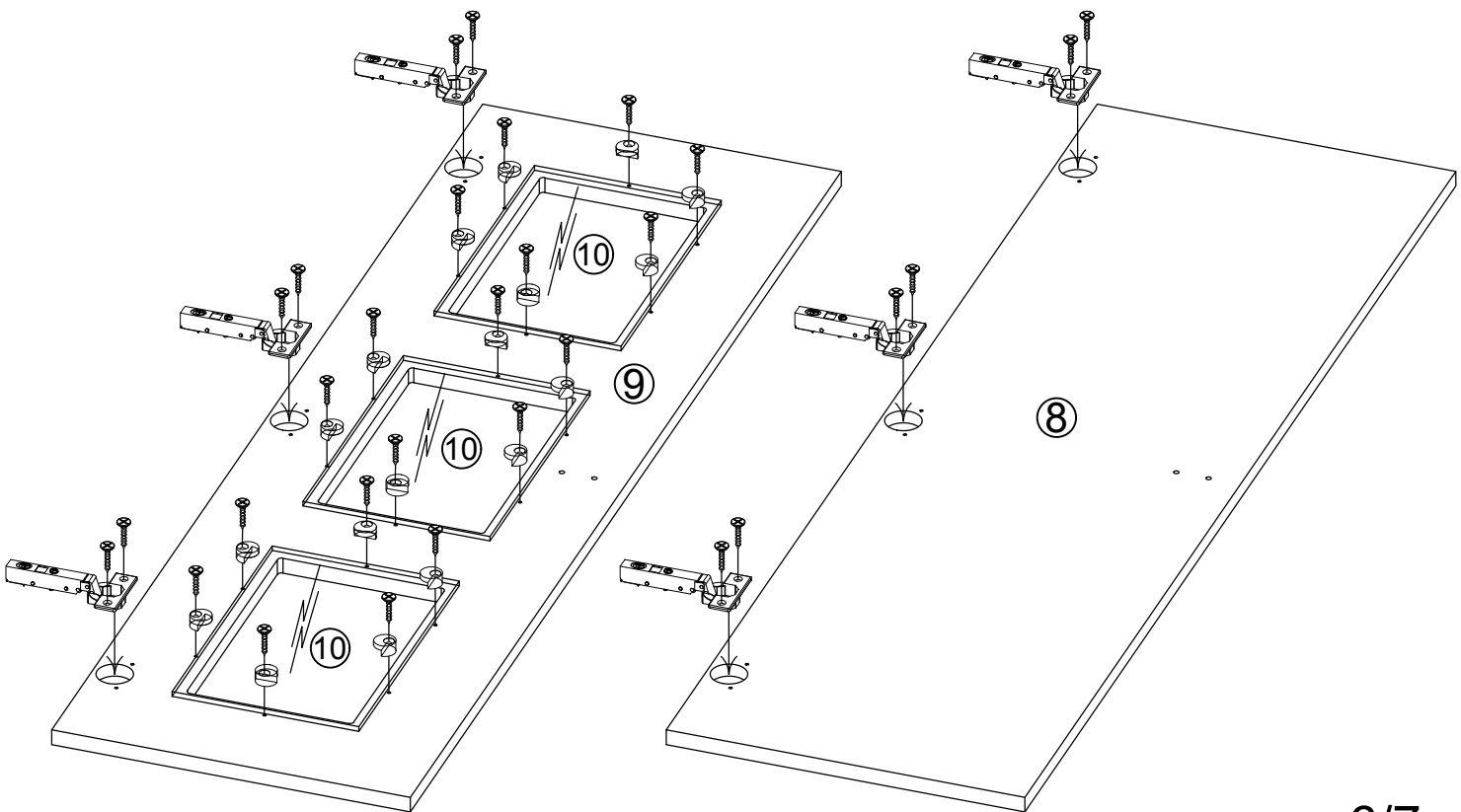
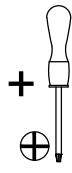

7

