

Assembly instructions

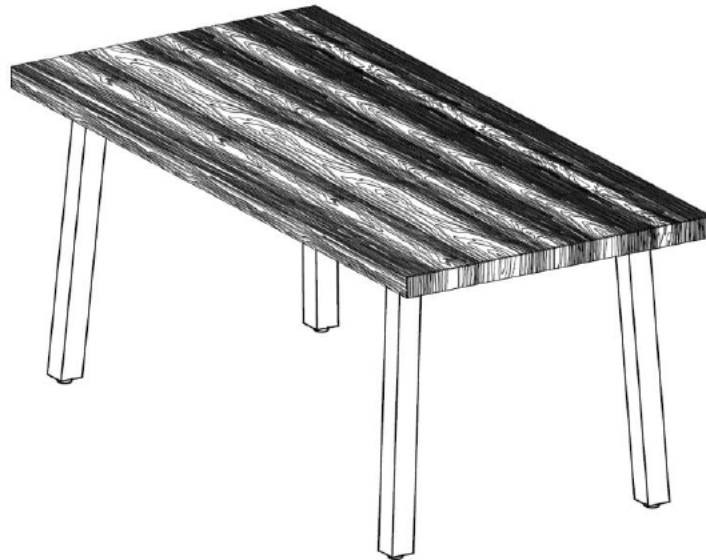

Caution: You must read this before you proceed

Table





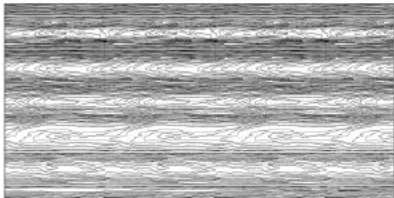

CAUTION: This table is NOT a TOY.
Keep your child / children at bay in the process of assembly.

Parts list

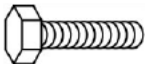
NO.	Picture	Description	QTY
A		Table Top	1
B		Leg with pre-attached Leveller	4

Hard ware

NO.	Picture	Description	QTY
①		Bolts(M8*30mm)	9
②		Spring Washers(8mm)	9
③		Washers(8mm)	9
④		Wrench	1

Assembly Preparation

Before Beginning Assembly:

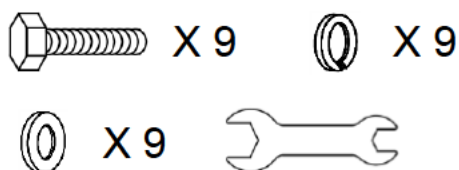
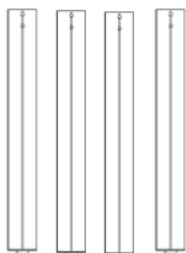
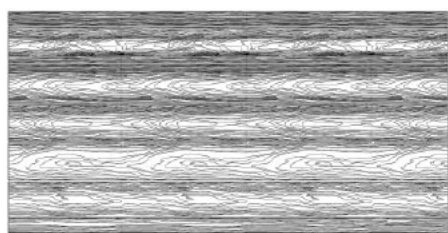

- Read instructions, cover to cover-



- Have 2 adults on hand for assembly-



- Do not assemble on flooring or carpet-



- Assemble on a clean non-marring surface (packing foam)-



- Save all packaging until finished-

Assembly Step

Overview

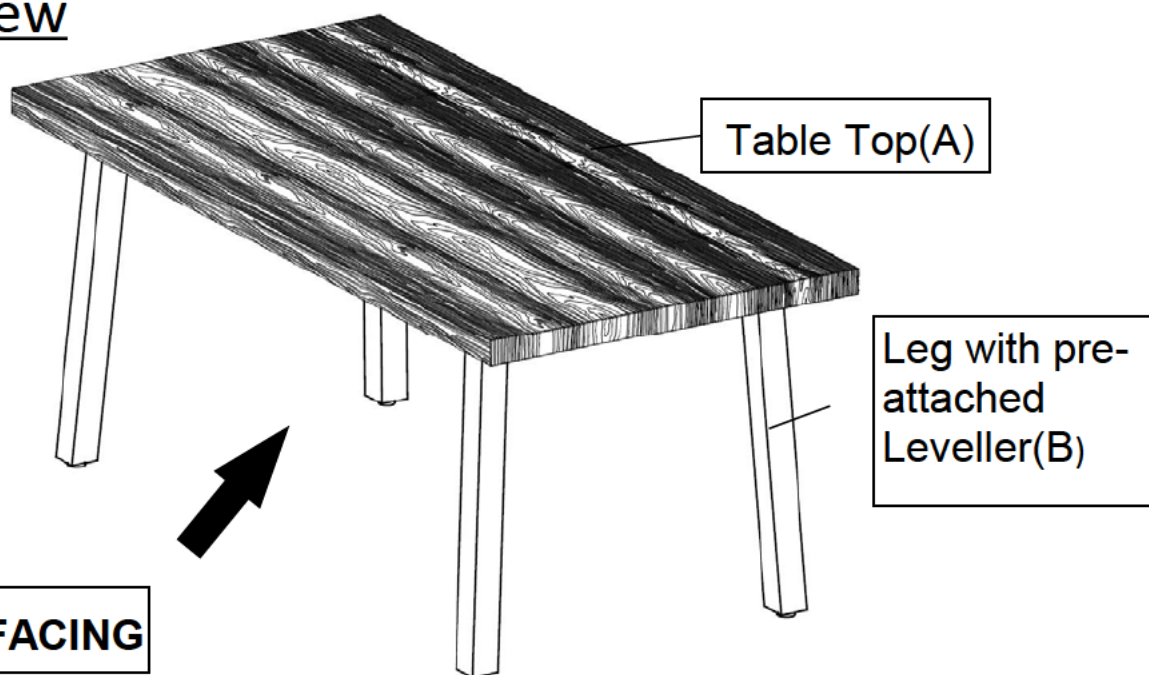

This Table has multiple parts and may require up to some 30 minutes to assemble.

To give you an overview of the parts, the above picture is to help you put the various parts into perspective.

Please read through the instructions below to familiarise yourself with the parts and steps before assembly.

Step 1

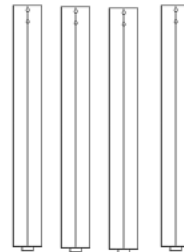
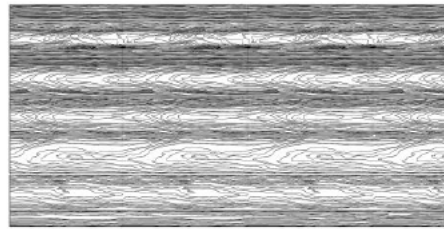

Unpack and place all parts onto a clean soft surface.

Step 2

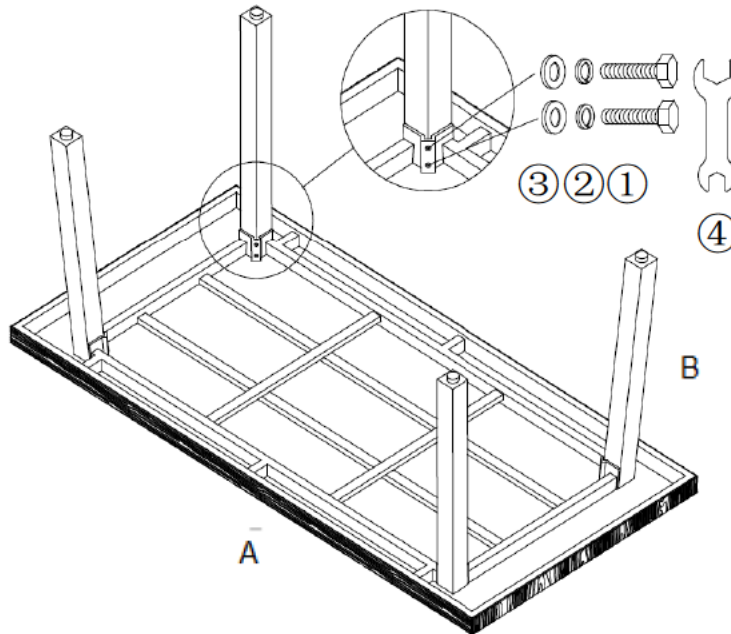

Turn the Table Top(A) upside down on o a soft surface to avoid scratching. Attach Leg with Pre-attached Leveller(B) to the mounting position on the Table Top(A) with Bolts(①), Spring Washers(②) and Washers(③) by Wrench(④).

Do not over tighten.

Step 3

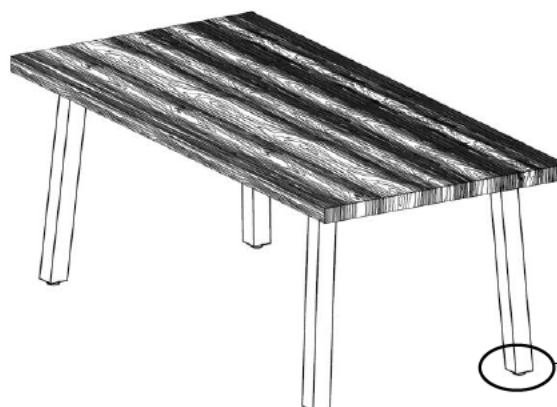

Adjust height
for balance

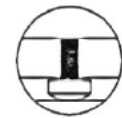

Adjust low for
balance

Adjust Pre-installed
Levellers
height for balance

Turn the Table rightside up.









Adjust the pre-installed Leveller until the table is level with the ground.

Then, proceed to tighten all Bolts.

Your table is ready for use.

Caution: This table can only be used on a flat, level surface.

Care & Maintenance

- ⊘  • Do not put hot items directly on furniture surface.
 - ⊘  • Do not clean furniture with harsh cleansers or polish.
 - ✓  • To obtain the longest lifespan of your outdoor products, minimizing exposure to direct sunlight is recommended.
 - ⊘  • Children should not climb or jump on the furniture.
 - ⊘  • Do not write on furniture without a padded barrier to protect the surface.
 - ✓  • To obtain the longest lifespan of your outdoor products, avoid extended and lengthy exposure to rain, snow, and direct sunshine. Whenever possible cover the product and /or place under patio or awnings.
 - ⊘  • Not for commercial use. For residential use only .
 - ⊘  • Stains may be removed with mild soap solution and damp cloth.
-
- ✓  • Dust and pick-up spills using a clean, non-colored, lint-free cloth .