

VEVOR®

ICE MAKER BY-70PF/90PF

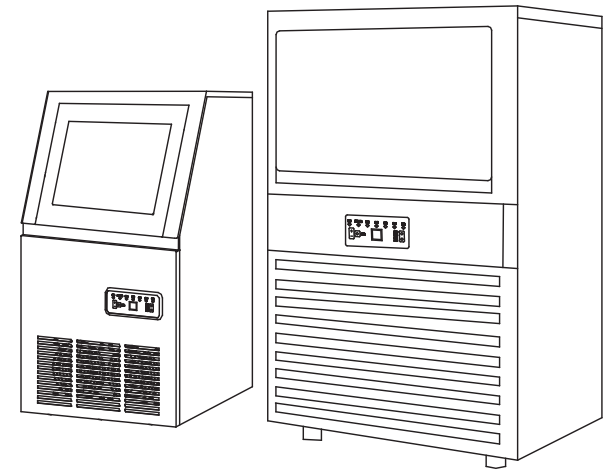

E-mail: support@vevor.com
E-mail: support@vevor.co.uk

IMPORTANT SAFETY INSTRUCTIONS

When using electrical appliances, basic safety precautions should be followed to reduce the risk of fire, electric shock and injury to persons or property. Read all instructions before operating the machine for the first time.

CAUTION:ICE CAN'T BE STORED IN THE ICE BIN DURING NIGHT-TIME, IT'S NOT FRIDGE, ICE WILL BE MELTED TO WATER AND FLOW OUT OF THE MACHINE.

1. If connect with water supply, CAUTION: must connect the potable water supply;
2. The machine is intended to be used in household and similar applications such as:
 - staff kitchen areas in shops,offices and other working environments;
 - farm houses
 - by clients in hotels,motels and other residential type environments;
 - Catering industry and similar non-retail industry.
3. The machine should be used in household and without obstacles surrounded, good ventilation place.There is must be 15cm at least between the four sides of the machine with the wall.
4. When using electrical appliances, basic safety precautions should be followed to reduce the risk of fire, electric shock and injury to persons or property. Read all instructions before using any appliance.
5. Don't operate this or any other appliance with a damaged cord.
6. Connect to properly polarized outlets only. No other appliance should be plugged into the same outlet. Be sure that the plug is fully inserted into the socket.
7. Don't place the machine and power cord near flammable material. Do not cover the cord. Do not submerge it in water.
8. We do not recommend the use of an extension cord,as it may overheat and become a risk of fire.
9. Unplug the ice maker before cleaning or making any repairs or servicing.
10. Exercise caution and supervision when the appliance is used near children.
11. Don't use your ice maker outdoors.Avoid direct sunlight and make sure that there is at least 5 inches of space between the back and sides of your unit and the wall.
12. Don't use any liquid other than water in the unit to make the ice.
13. Do not clean your ice maker with flammable detergents. The fumes can create a fire hazard or explosion.
14. Do not tip the machine over.
15. If the ice maker is brought indoors from outdoors during the wintertime,give it a few hours to warm up to room temperature before plugging to power source.

Common malfunction analysis

E1	Ice full indicator is on,and proximity switch didn't react	Evaporator connector didn't assemble well	Re-install the connector	
		Proximity switch is not sensitive	Replace the switch	
		The connector didn't return to original position	Take away the ice to make the connector return to original position	
E2	Normal to make ice	Stop every 4 cycles,and the process of ice drop continued for 5 min	Proximity switch is not sensitive,replace it	
	No water in the tank	The water tank is not plugged	Put the plug back	
		Use tap water as water source	Check the water supply	
	Water in the tank	Use tap water as water source	Water pressure is too high,water float can't work.Adjust the water pressure or replace by a new one.	
No water or low flow		Pump is badly clogged up,replace or clean it		
E2	Water flow and water get cool	Thin ice on the evaporator	Increase the making time through "+"	
		very solid ice on the evaporator	Reduce the making time through "-"	
		Some water sprayed to ice storage tank	Adjust the spray pipe	
		The water leak from the back of water tank	The tank need to be adjusted.	
	Water flow down but water is not cool	The main board didn't supply electricity to compressor	Replace by a new main board	
		Compressor didn't work	Check the starter,replace by a new one if needed	
		Compressor is very hot	Replace	
		Compressor work but the connected copper pipe didn't get cool	The compressor leak	
	E3	The fan is not work	The condenser prob is not sensitive	Unplug the prob or replace by a new one
			The fan is jammed	Adjust the fan
Fan is broken			Replace by a new fan	
E4	Ice full	The connector didn't return to original position	Take away the ice to make the connector return to original position	

Explosion diagram

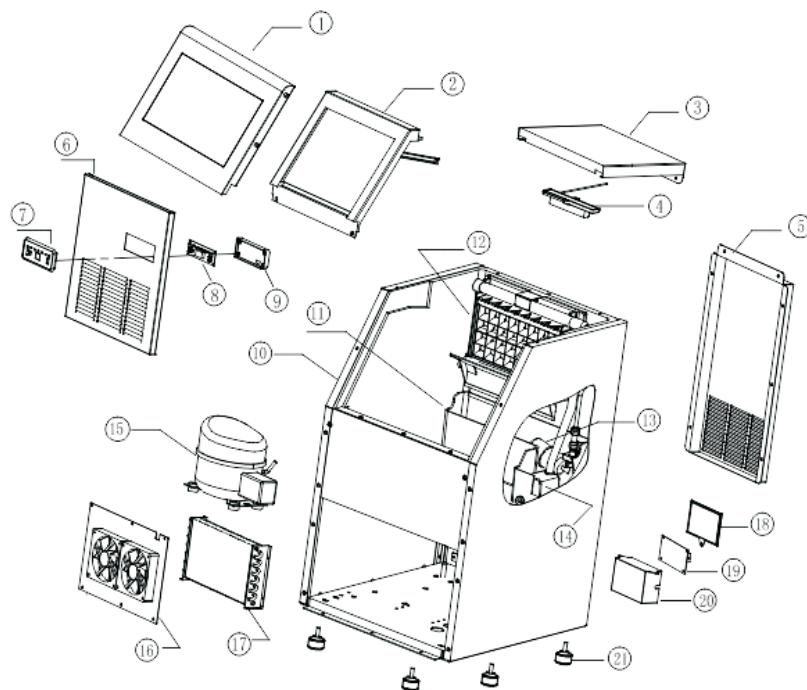

- | | | |
|---------------------|----------------|---------------------|
| 1. visible door | 8. light board | 15. compressor |
| 2. door frame | 9. board cover | 16. DV fan |
| 3. top cover | 10. inner tank | 17. condenser |
| 4. blue light board | 11. water tank | 18. mainboard cover |
| 5. back panel | 12. evaporator | 19. mainboard |
| 6. front panel | 13. float | 20. mainboard box |
| 7. display board | 14. pump | 21. rubber feet |

16. This unit should be properly grounded for your safety. The power cord is equipped with a three-prong plug which mated with standard three-prong wall outlets to minimize the possibility of electric shock.
17. Plug your appliance into a dedicated, properly installed and grounded wall outlet. Do not, under any circumstance power and /or grounding should be directed toward a certified electrician.
18. The foaming materials inside is combustible which must be kept away from fire.
19. It's forbidden to pull the cable to unplug the plug, pull the plug is a must.

WARNING: This appliance must be grounded.

- 1) The fuse on the PCB is 8A (220V machine), if 110-120V machine, the fuse is 15A, if change, must be operated by a technician.
- 2) voltage fluctuation can't be exceeded $\pm 10\%$ than rated voltage, or a Voltage stabilizer is needed.







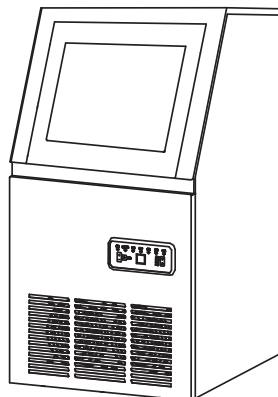

IMPORTANT: To avoid hazards due to instability, the unit must be placed on an even and flat surface.

Package Contents

Ice Maker Machine x 1



Warm Tips: Check whether all below accessories are there

Accessories list				
NO	Description	Picture	Usage	QTY
1	Manual		Operation manual	1PC
2	Filter		Filter water	1PC
3	Drainage pipe		Drain	1PC
4	Ice spoon		Take ice cubes	1PC
5	nylon cable ties		Fix pipe if needed	2PCS
6	Hoop		fasten the outlet and the drainage pipe together if needed	1PC
7	Seal ring		Do put it in the faucet of the intake pipe. The other one is spare.	2PCS
8	Spare blue clip		Spare blue clip if needed.	2PCS
9	Spare plug		Spare plug which plug the tank if needed.	1PC

MAINTENANCE

Pump cleaning

The pump must be cleaned once a week. Unplug the machine before cleaning, take out the pump from the tank, clean the inlet of the pump with a small brush, and install it back after cleaning.

Special instruction:

1. The machine will detect the around ambient temperature and set the ice making time automatically.
2. The system will get to normal after 3 cycles.
3. The user can choose their desired size through “+” and “-” button.
4. As the production of ice cubes increases, the plastic panel inside the machine (shown above) might be pressed down by the ice cubes. When the plastic panel is pressed down, the machine will stop producing ice cubes automatically and the “stoppage” indicator will light on. Please clean out the ice cubes regularly for continuation of ice making.

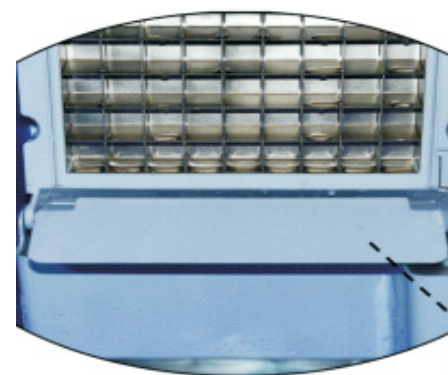

Plastic Panel

“+”and“-” button:

Through “+”/“-” to increase or decrease ice making time or set the auto-turning-on/ off time,the “thickness adjust” indicator will be always on.

Ice making time can be adjusted from -8 to 8min.(e.g. if display 15,press “-” to adjust to -2,will display 13,that’s mean,ice making time was adjusted to 13min)

Min/H: 

Display ice making countdown time (in minute),display increase or decrease ice making time (in minute),display reserve auto-turning-on/off time (in hours)

CLEANING & MAINTENANCE

CLEANING

Please thoroughly clean your ice maker before initial use.

Exterior: the outside of the ice maker should be cleaned regularly with a mild detergent and warm water. Always use a soft cloth to avoid scratching or damaging the housing.

INTERIOR: please use the following Self-Clean function:

1. Add water and vinegar or lemon juice mix (1:1 ratio)
2. Plug in unit,press and hold the CLEAN button for approximately 3s seconds,then release.The unit will automatically enter Self-clean program. This process takes about 5-6 minutes.When the Self-Clean program is finished,unit will automatically power off.
3. The fan blade will be rotating.This process rinses the inside parts several times.
4. After the Self-Clean program is completed,unplug the power cord and drain out the water by unplugging the drain cap on the side.Replace drain cap.
5. Add fresh water to the water reservoir,up to the water level mark.
6. Plug the unit and repeat the Self-Clean process by repeating steps 3 to 5. This will rinse out the vinegar/lemon residue.
7. After draining the water,replace and tighten drain cap.
8. Dry the interior and exterior with a clean,soft cloth.

NOTE: It is strongly recommended to clean the unit before initial use or after the unit has not been in use for a long period of time.

OPERATING PROCEDURES

UNPACKING YOUR ICE MAKER

1. Remove all exterior and interior packaging materials. **After you unpack the machine, we recommend you to leaving it for 24 hours before turning it on.**
2. Clean the interior with lukewarm water and a soft cloth or clean the unit using the Self-Clean function.
3. Find a location for your ice maker where it’s protected from direct sunlight and other sources of heat (i.e. stove, furnace, radiator). Place the ice maker on a level surface. Make sure that there is at least 5 inches of space between the back and sides of your ice maker and the wall.
4. Allow one hour for the refrigerant to settle before plugging the unit for initial use.
5. The appliance must be positioned where the plug is accessible.

CONNECTING YOUR ICE MAKER WITH OTHER PARTS

Please connect your ice maker with other parts by referring the diagram bel

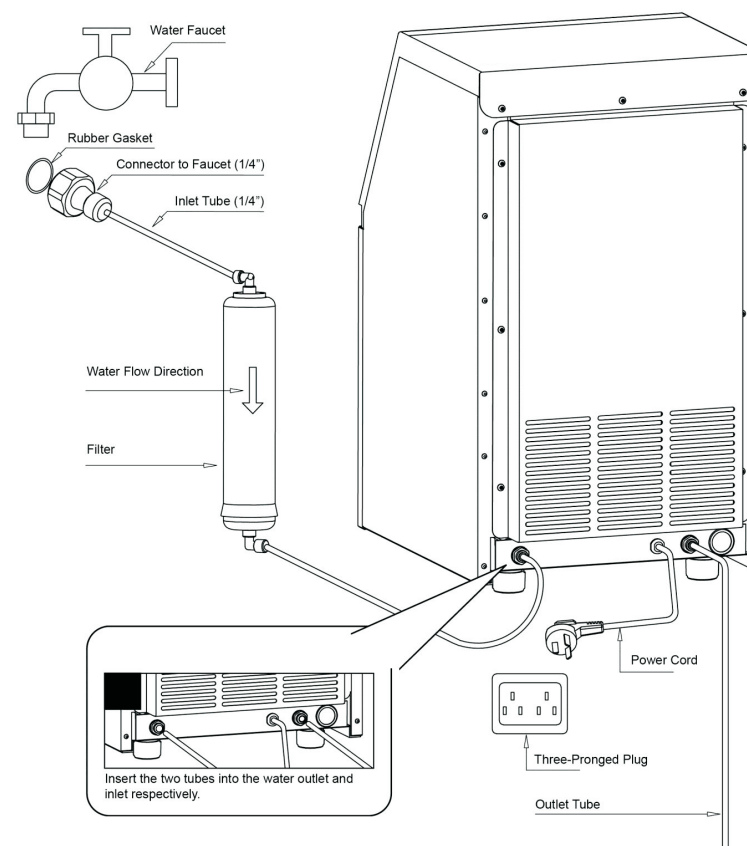

Connect drainage pipe and water intake pipe

- Warning:**
1. The machine can only connect with drinking water sources, and must meet local drinking water standards
 2. The water pressure must be in 0.1-0.4Mpa, if exceed 0.4Mpa, a pressure reducing valve must be connected.
 3. Drainage: The outlet of the drainage pipe must be lower than the outlet on the machine

Connect to the filter

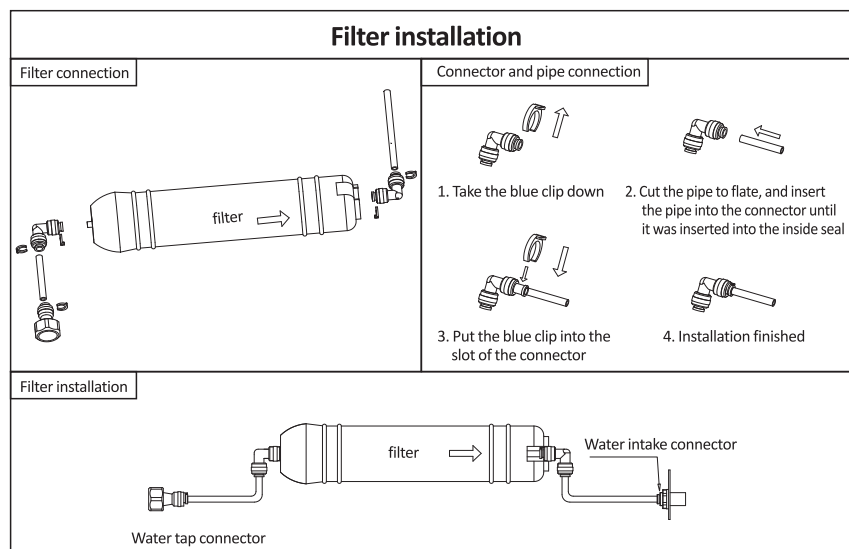

MACHINE OPERATIONS

Operation Panel



Ice making operation

ON/OFF BUTTON:

Press this button under standby mode(display "--") to make the machine to work,press the button for 2 seconds during working time,the machine will be power off.

Cleaning/Reservation:

Long press this button for 3s under standby mode to make the enter cleaning mode for 5min and with cleaning indicator is on.And it will enter standby mode after cleaning.

Press cleaning button during cleaning mode to make the machine end the cleaning in advance.

Press this button under standby mode with the reservation indicator Flicker. and the "+" / "-" button to set the auto-turning-on time (in hours from 0-23h). The machine will automatically turns on after The countdown is finished.and the "+" / "-" button to set the auto-turning-off time (in hours from 0-23h). The machine will automatically turns off after the countdown is finished.

If we succeed in reservation,the reservation light will be always on.

Press reservation button to cancel the reservation and the reservation indicator will be off.

HOT:

You can long press the "Hot" button 3 second during the ice making to make the ice cubes drop from the ice mold ahead of time.

Press "HOT" to turn off the blue light,press again to turn it on.