

## Contact Us !

---

**Do NOT return this item.**

Contact our friendly customer service department for help first.

**USER'S MANUAL**

**Full (Queen) Bed**

THIS INSTRUCTION BOOKLET CONTAINS **IMPORTANT** SAFETY INFORMATION. PLEASE READ AND KEEP FOR FUTURE REFERENCE.







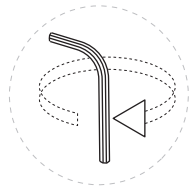
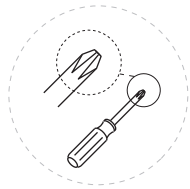
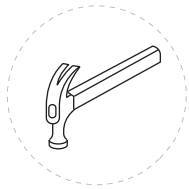
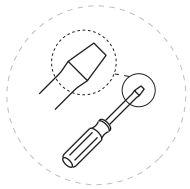

# Before You Start



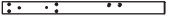
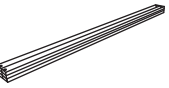
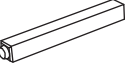

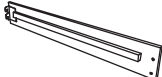

- ⚠ Read each step carefully before starting. It is very important to ensure each step followed in correct order, otherwise assembly difficulties may occur.
- ⚠ Most of board parts are labeled or stamped on the raw edges. Have a check to make sure all parts are included.
- ⚠ Work in a spacious area, preferably on a carpet close to where the unit will be used.
- ⚠ Keep the handtools close at hand. Do not use power tools to assemble your furniture. They may scratch or damage the parts.



## PARTS LIST

- |                                   |   |                                    |   |
|-----------------------------------|---|------------------------------------|---|
| <b>A</b> x1<br>Headboard          |  | <b>B</b> x1<br>Footboard           |  |
| <b>C</b> x2<br>Headboard Leg(L&R) |  | <b>D</b> x12<br>Bed Roll-Out Slats |  |
| <b>E</b> x4<br>Bed Slats Support  |  | <b>F</b> x2<br>Side Rail Left      |  |
| <b>G</b> x2<br>Side Rail Right    |  | <b>H</b> x2<br>Center Slats        |  |
| <b>I</b> x2<br>Side Rail Leg      |  |                                    |   |

## HARDWARE LIST

- |  |   |         |
|--|---|---------|
| <b>1</b>   JCBC<br>x12                                       |    | M6x30mm |
| <b>2</b>   JCBC<br>x4  |    | M6x50mm |
| <b>3</b>   Flat Washer 1/4"ID x19mmOD Blk<br>x12             |  |         |
| <b>4</b>   ALLEN KEY<br>x1<br>M4x65mm Blk<br>(FOR HB LEG)    |  |         |
| <b>5</b>   ALLEN KEY<br>x1<br>M5x65mm Blk<br>(FOR SIDE RAIL) |  |         |
| <b>6</b>   Flat Head Chipboard Screw<br>x32<br>M4x32mm Rbw   |  |         |

### STEP 1.1

Attach Head Board Leg (C) to Head Board (A) as shown using JCBC BOLT (1) with Flat Washer (3) and securing with ALLEN KEY (4).

### STEP 1.2

Fix the other holes with Screws (6) as shown.

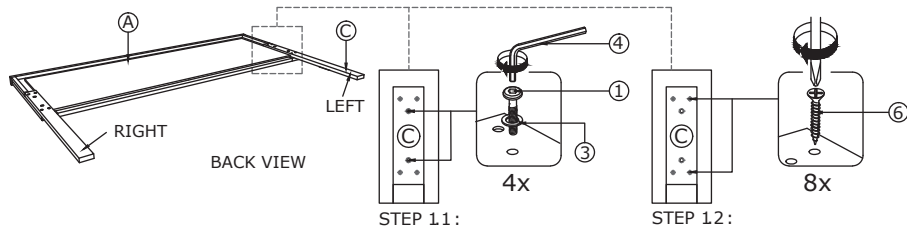

**NOTE:** TIGHTEN SCREWS PERIODCALLY AS SCREWS WILL BECOME LOOSE WITH USE. CHECK TIGHTNESS OF ALL SCREW EVERY 6-8 WEEKS.

### STEP 2.1

Attach Side Rail (F) & (G) to the Side Rail Leg (I) as shown using JCBC BOLT (1) with Flat Washer (3) and securing with ALLEN KEY (4) by outside side rail (F) & (G).

### STEP 2.2

Loosen JCBB Bolt at Headboard & Footboard Leg using Allen Key (5). (Do not tighten them before hooking SET-UPSIDE RAIL TO HEAD BOARD (A) closely, and push down to fit and tighten them accordingly.)

Repeat step 2.2 with other end of rail to hook onto FOOTBOARD (B).

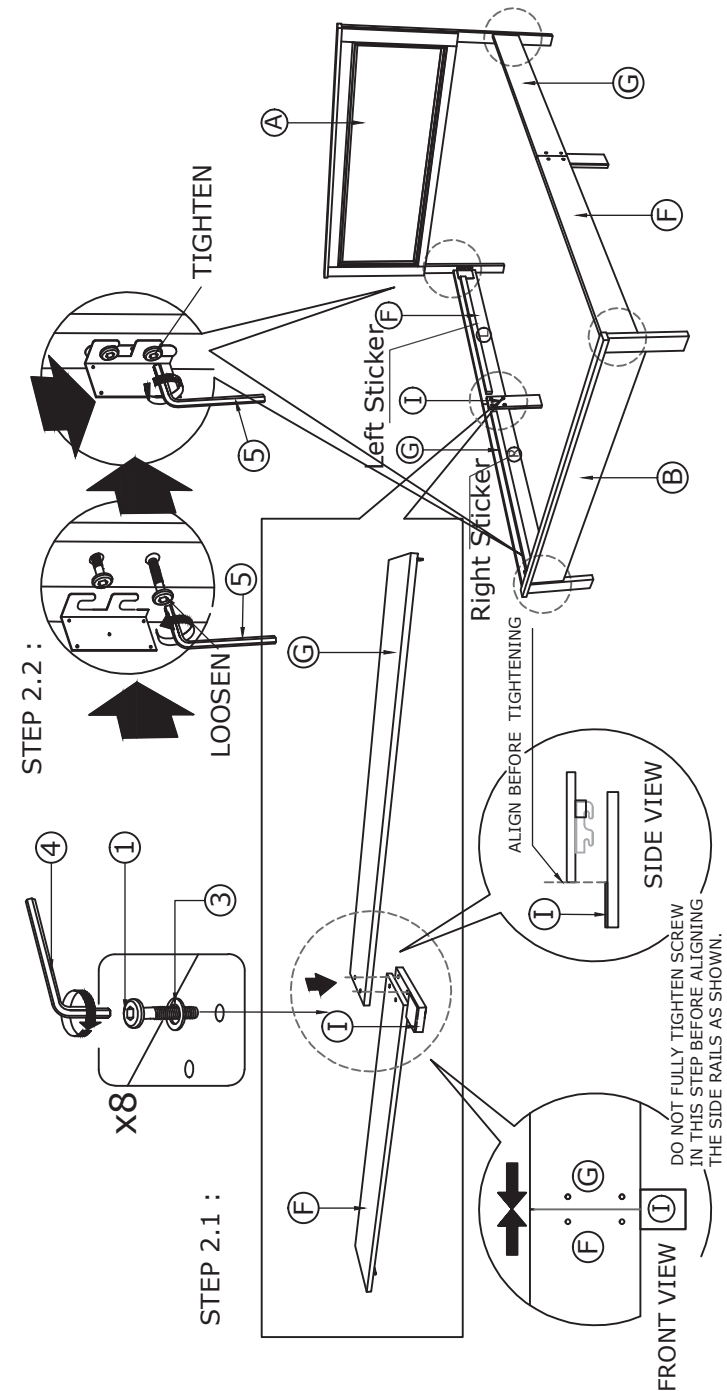

### STEP 3

Fix the Bed Slat Supports (E) to the bed slats (D) and Center Slats (H), then tighten with JCBC Bolts (2) as shown. Install the bed slat (D) to Side Rail (F) & (G), and tighten with Screws (6) as shown. (NOTE: THE SETUP MUST BE DONE AT THE DECIDED LOCATION FOR THE BED TO OBTAIN PERFECT STABILITY.)

Repeat Step 3 for other set of slats assembly.

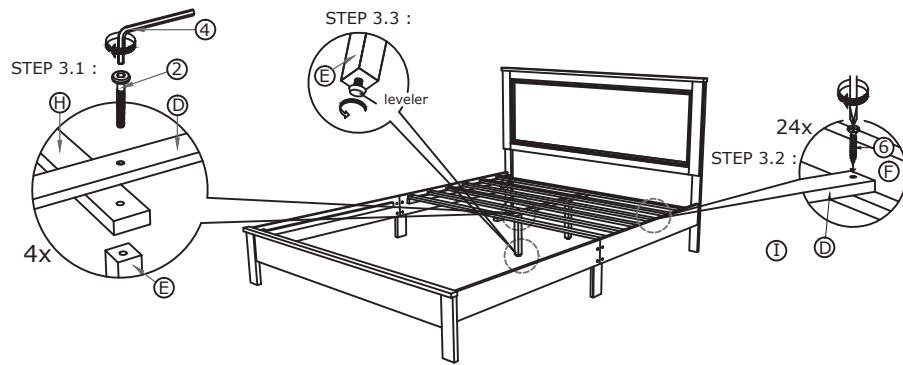

Push the Side Rail (F) & (G) to meet with wooden slat (D) and fix the Screw (6) by using the Screw Driver.

**NOTE:** TIGHTEN SCREWS PERIODICALLY AS SCREWS WILL BECOME LOOSE WITH USE. CHECK TIGHTNESS OF ALL SCREW EVERY 6-8 WEEKS.

## Care and Maintenance

Use a soft, clean cloth that will not scratch the surface when dusting.

Use of furniture polish is not necessary.

Should you choose to use polish, test first in an inconspicuous area.

Using solvents of any kind on your furniture may damage the finish.

Never use water to clean your furniture as it may cause damage to the finish.

Liquid spills should be removed immediately. Using a soft clean cloth, blot the spill gently. Avoid rubbing.

Check bolts/screws periodically and tighten them if necessary.

## Further advice about wood furniture care

It is best to keep your furniture in a climate-controlled environment.

Extreme temperature and humidity changes can cause fading, warping, shrinking and splitting of wood.

It is advised to keep furniture away from direct sunlight as sun may damage the finish.

Proper care and cleaning at home will extend the life of your purchase.

Following these important and helpful tips will enhance your furniture as it ages.