

Assembly Instructions

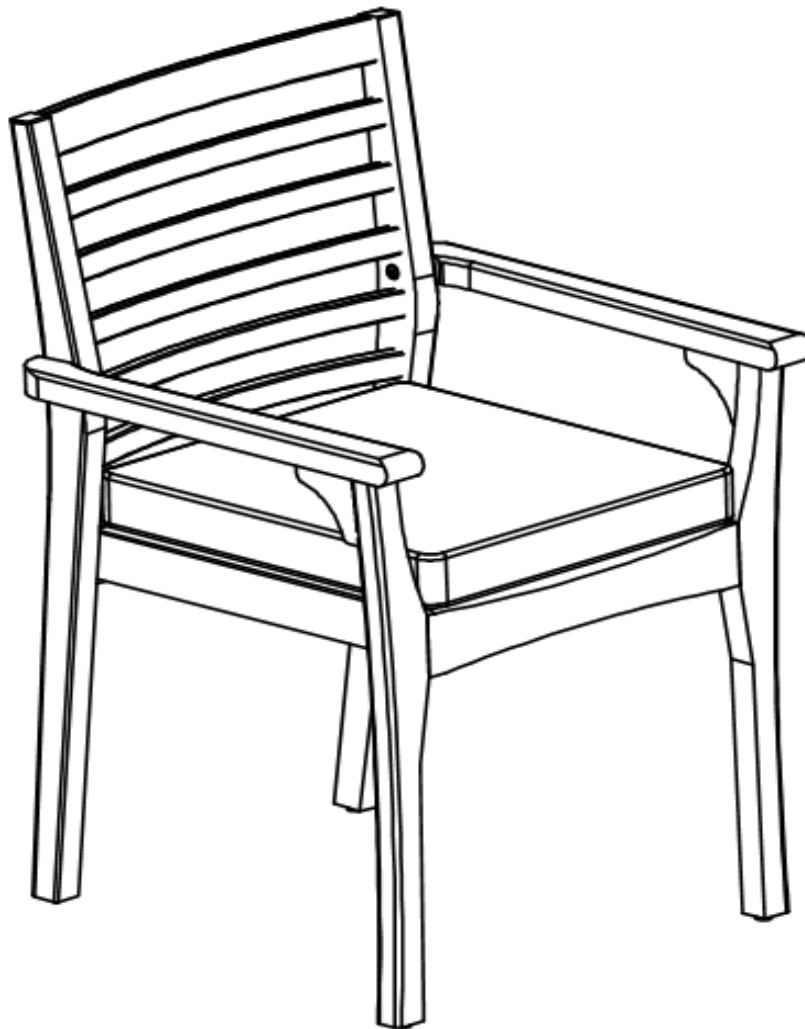





CAUTION: You must read this before you proceed

CHAIR





CAUTION : This Chair is NOT a TOY. Keep your child / children at bay in the process of assembly. For turning the Chair and to prevent damage to the Chair, 02 persons may be needed to execute this action.

Parts List

Label	Picture	Description	Qty
A		Backrest Panel	1
B		Front Leg Panel	1
C		Seat Panel	1
D		Right Arm Panel	1
E		Left Arm Panel	1
F		Seat Cushion	1





Hardware

No.	Picture	Description	Qty
①		Allen Key	2
②		Screw (M6*35mm)	3
③		Bolt (M6*45mm)	9

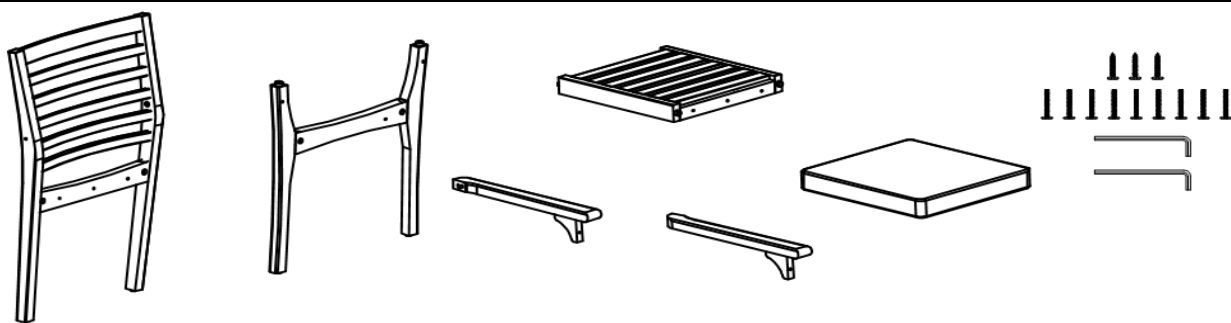
Assembly Preparation

Before Beginning Assembly:



-  • Read instructions, cover to cover-
-  • Have 2 adults on hand for assembly-
-  • Do not assemble on flooring or carpet-
-  • Assemble on a clean non-marring surface (packing foam)-
-  • Save all packaging until finished-

Assembly Steps

OVERVIEW

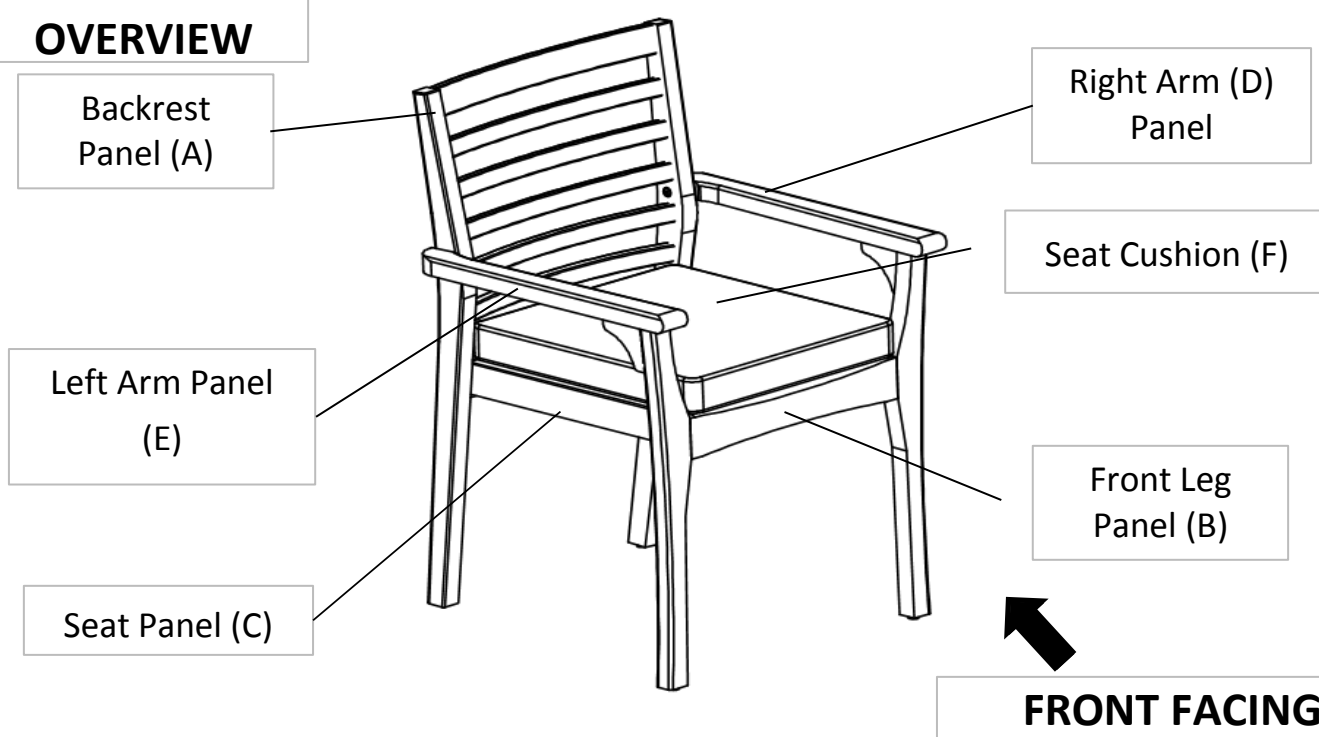

This Chair has multiple parts and may require up to some 30 minutes to assemble. To give you an overview of the Chair the above picture to assemble to help you put the various parts into perspective. Please read through the instructions here below to familiarise the parts and steps before assembly.

Step 1

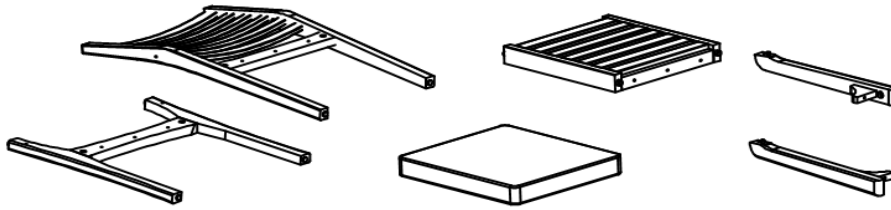

Unpack and place all parts on a clean, non-marring surface.

Step 2

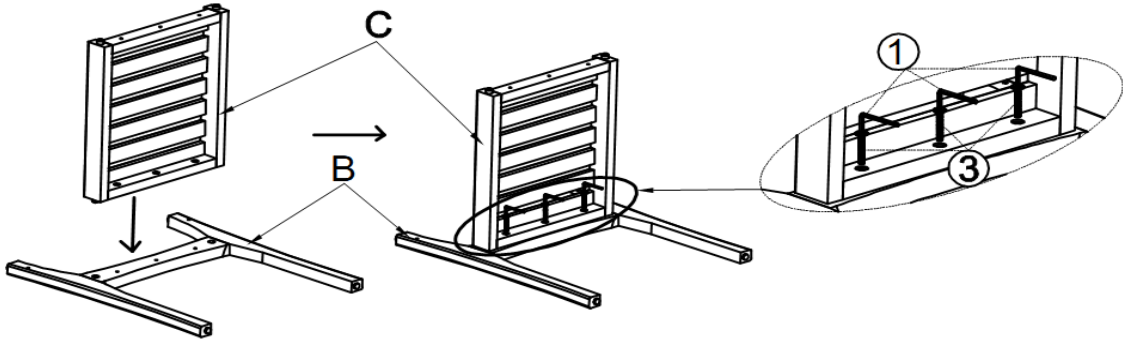

Place Front Leg Panel (B) with its underside facing skywards onto a clean, soft surface to avoid any scratch or damage to the product.
Attach Seat Panel (C) to Front Leg Panel (B) using 3 Bolts (③) and Allen Key (①).

Do not fully tighten the Bolts.

Step 3

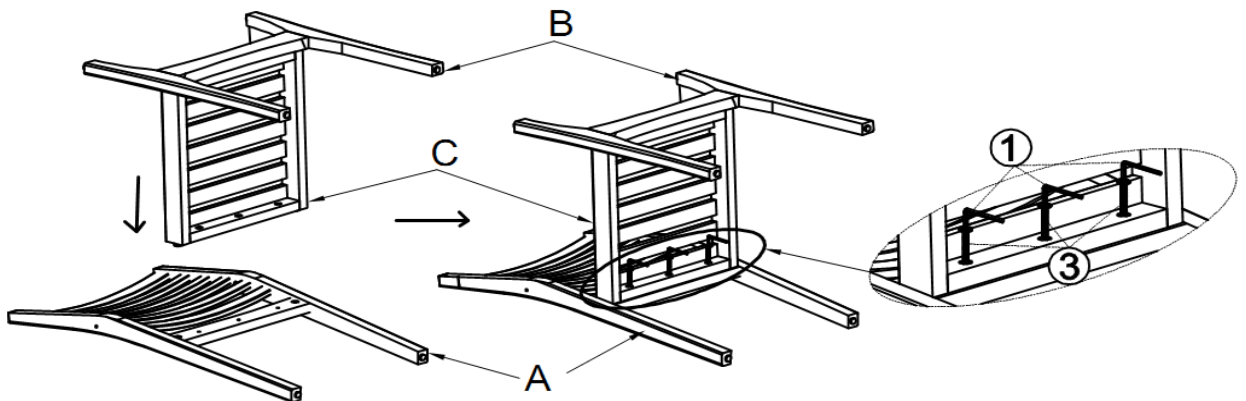

Place Backrest Panel (A) with its underside facing skywards onto a clean, soft surface to avoid any scratch or damage to the product.

Position Seat Panel (C) with Front Leg Panel (B) to Backrest Panel (A) as the picture above, then using 3 Bolts (③) and Allen Key (①) to secure these parts.

Do not fully tighten the Bolts.

Step 4

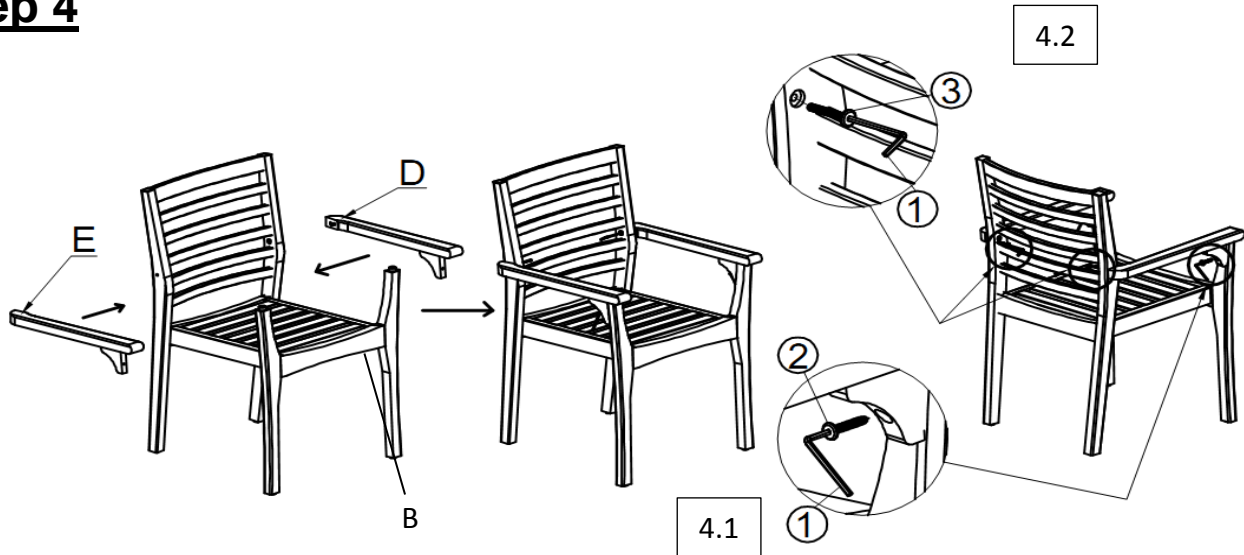

With assistance from your adult partners, turn the chair in right side up. Position Right Arm Panel (D) and Left Arm Panel (E) onto the tenon of Front Leg Panel (B).

4.1) Secure Right Arm Panel (D) and Left Arm Panel (E) to Front Leg Panel (B) using 2 Screws (②) and Allen Key (①).

4.2) Attach Right Arm Panel (D) and Left Arm Panel (E) to Backrest Panel (A) using 2 Bolts (③) and Allen Key (①).

Do not fully tighten Screws and Bolts.

Step 5

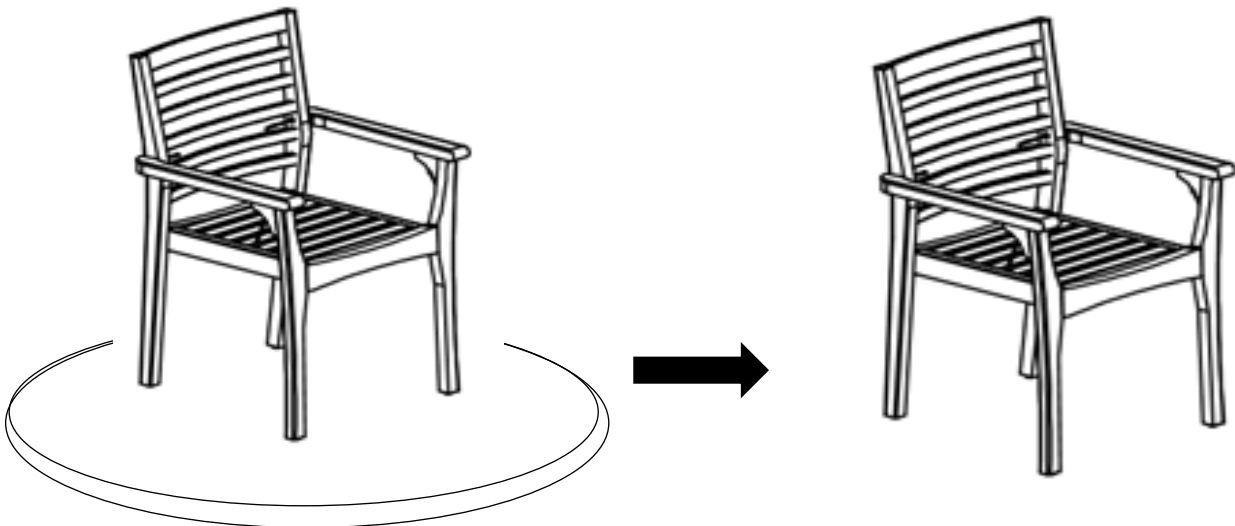





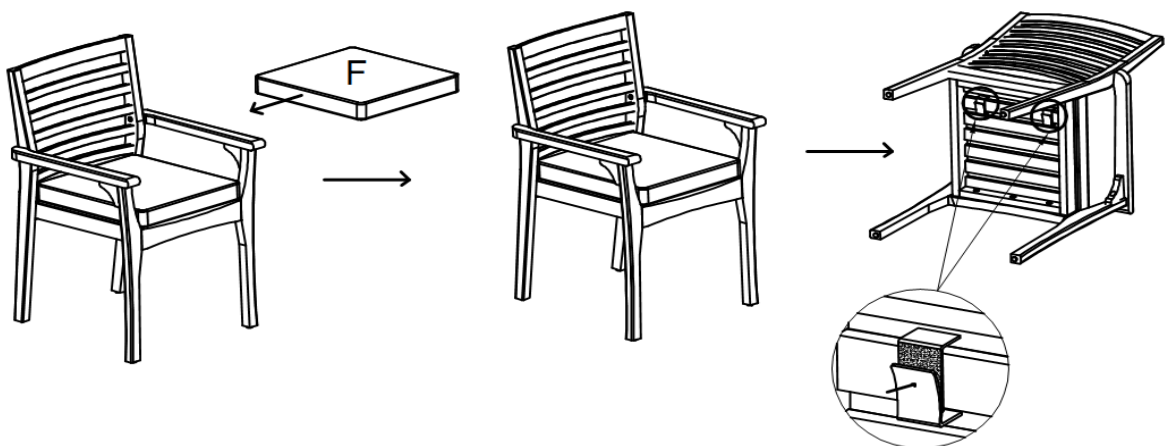



Stand the Chair up, with assistance from your adult partner.
Exert pressure floorwards, onto the Chair with both your hands.
This pressure will help the Legs and Chair reach full alignment status.
Check for wobbles on a LEVEL surface.
If no wobbles are found proceed to tighten Bolts and Screws in a sequential manner, until evenly secured.
When tightening Bolts and Screws tighten sequentially.
Do not tighten any Bolt and Screw fully and then move on towards the next one.
If there are still wobbles, loosen Bolts and Screws and excute the same above process.

Step 6



Place Seat Cushion (F) on to the Chair and lay down the Chair, then tie the velcro straps of Seat Cushion (F) to Seat Panel (C) as shown above.
Your Chair is ready for use.
This Chair can only be used on a flat, level surface.

Care & Maintenance

- ⊘  ● Do not put hot items directly on furniture surface.
 - ⊘  ● Do not clean furniture with harsh cleansers or polish.
 - ✓  ● To obtain the longest lifespan of your outdoor products, minimizing exposure to direct sunlight is recommended.
 - ⊘  ● Children should not climb or jump on the furniture.
 - ⊘  ● Do not write on furniture without a padded barrier to protect the surface.
 - ✓  ● To obtain the longest lifespan of your outdoor products, avoid extended and lengthy exposure to rain, snow, and direct sunshine. Whenever possible cover the product and /or place under patio or awnings.
 - ⊘  ● Not for commercial use. For residential use only.
 - ⊘  ● Stains may be removed with mild soap solution and damp cloth.
 - ✓  ● Dust and pick-up spills using a clean, non-colored, lint-free cloth .
-