

### Features

- Performance showering packages offer increased functionality and simplify the ordering process
- Includes handshower, showerhead, 60" handshower hose, shower arm with diverter, 30" slidebar, and Purist® Rite-Temp® valve trim
- Single lever handle provides on/off activation and temperature setting with a single operation
- Multifunction showerhead with advanced spray engine provides three experiences: full coverage, pulsating massage and silk spray
- Multifunction handshower with advanced spray engine provides three experiences: full coverage, pulsating massage and silk spray
- Thumb tab allows for a smooth transition between sprays
- Shower arm with diverter makes it easy to switch the water flow between showerhead and handshower
- MasterClean™ sprayface features an easy-to-clean surface that withstands mineral buildup and maximizes spray performance
- 1.75 gpm (6.6 lpm) flow rate.
- Coordinates with Purist faucets, accessories, and showering components to complete your bathroom
- Requires Rite-Temp® pressure-balancing valve (sold separately)
- Features a nonpositive shutoff: water-saving pause mode to temporarily reduce water flow



### Codes/Standards

ASME A112.18.1/CSA B125.1  
DOE - Energy Policy Act 1992  
EPA WaterSense®  
California Energy Commission (CEC)  
IAPMO Certification

### KOHLER® Faucet Lifetime Limited Warranty

See website for detailed warranty information.

### Material

- KOHLER® finishes resist corrosion and tarnishing

### Required Products/Accessories

K-8304 Series Rite-Temp® Valve & Cartridge Kits

or

K-8300 Series Rite-Temp® Valve Body Rough-ins  
K-8305 Series Rite-Temp® Cartridges

### Recommended Products/Accessories

K-23723 Faucet cleaner

### Optional Products/Accessories









K-10350 Deep rough-in kit  
K-10351 Test cap for K-8300 Series valve bodies

### Included Components

105527 Handshower Relaxing  
K-349 Slidebar trim kit  
K-8524 30" slidebar  
K-9514 60" Shower Hose

### Available Colors/Finishes

*Color tiles intended for reference only.*

Color	Code	Description
	CP	Polished Chrome
	SN	Vibrant® Polished Nickel
	AF	Vibrant® French Gold
	BN	Vibrant® Brushed Nickel
	BV	Vibrant® Brushed Bronze
	BL	Matte Black
	2MB	Vibrant® Brushed Moderne Brass
	TT	Vibrant Titanium

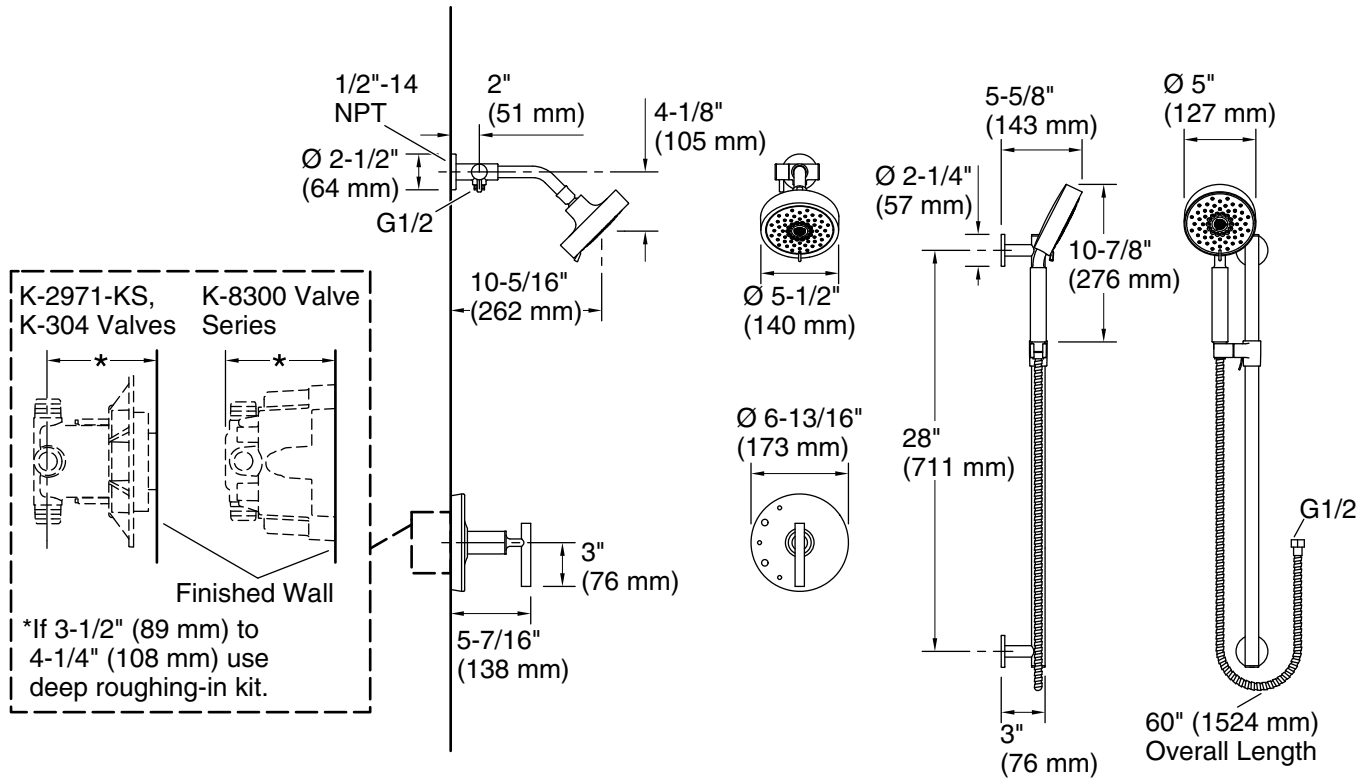

### Technical Information

All product dimensions are nominal.

Drain included: No

### Handshower:

Rated maximum flow: 1.75 gal/min (6.6 l/min)

### Showerhead/Body Spray:

Rated maximum flow: 1.75 gal/min (6.6 l/min)

### Notes

Install this product according to the installation instructions.

**IMPORTANT!** The slide bar must be mounted to stud framing supports at both the top and bottom mounting locations. Plastic wall anchors will not support the slide bar. Do not use or depend on plastic wall anchors to attach the slide bar.

Plumbing codes may require that an atmospheric vacuum breaker be installed in-line to handshowers. Consult with local codes.

Install straight pipe or tube drop of 7" (178 mm) to 18" (457 mm) with single elbow between the valve and the wall-mount spout.

**NOTICE:** Risk of product damage. Long screws, for installing trim, can damage the K-2971-KS valve. Consult the trim installation guide to verify if the thin wall installation kit (88526) is needed.