



















stylor bed











1

ASSEMBLY INSTRUCTION

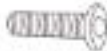
PartsList

<p>A</p>  <p>x1</p>	<p>B</p>  <p>B(L)x1 B(R)x1 x1</p>	<p>C</p>  <p>C(L)x1 C(R)x1 x2</p>	<p>D</p>  <p>x1</p>
<p>E</p>  <p>x2</p>	<p>F</p>  <p>x2</p>	<p>G</p>  <p>x2</p>	<p>H</p>  <p>x2</p>
<p>I</p>  <p>x1</p>	<p>J</p>  <p>x2</p>	<p>K</p>  <p>x20</p>	<p>L</p>  <p>Legs x2</p>
<p>M</p>  <p>Single holes x20</p>	<p>N</p>  <p>Both holes x10</p>	<p>O</p>  <p>x1</p>	<p>P</p>  <p>x1</p>
<p>Q</p>  <p>x2</p>	<p>R</p>  <p>x1</p>		

HardwareList

<p>① M4x55</p>  <p>4pcs</p>	<p>② M6x50</p>  <p>6pcs</p>	<p>③ M6x45</p>  <p>12pcs</p>	<p>④ M6x40</p>  <p>21pcs</p>	<p>⑤ M6x30</p>  <p>10pcs</p>
<p>⑥ M6x16</p>  <p>8pcs</p>	<p>⑦</p>  <p>2pcs</p>	<p>⑧</p>  <p>22pcs</p>	<p>⑨</p>  <p>1pc</p>	

1

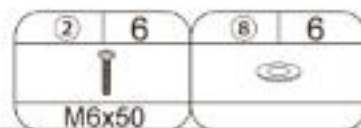
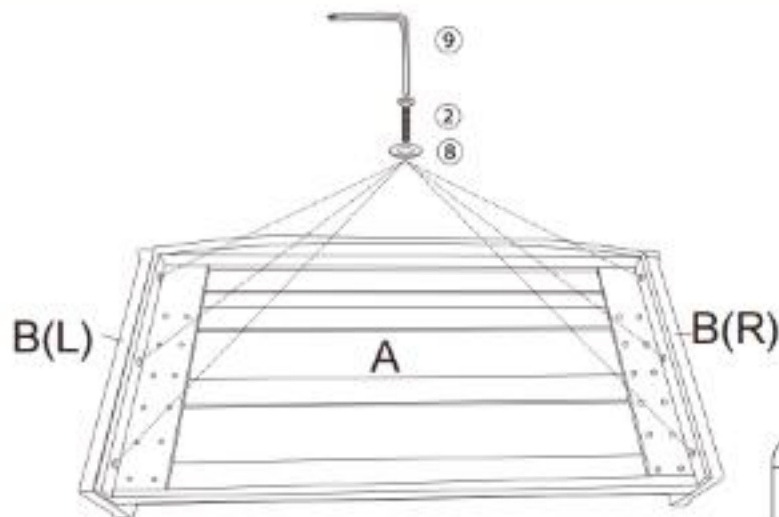

2

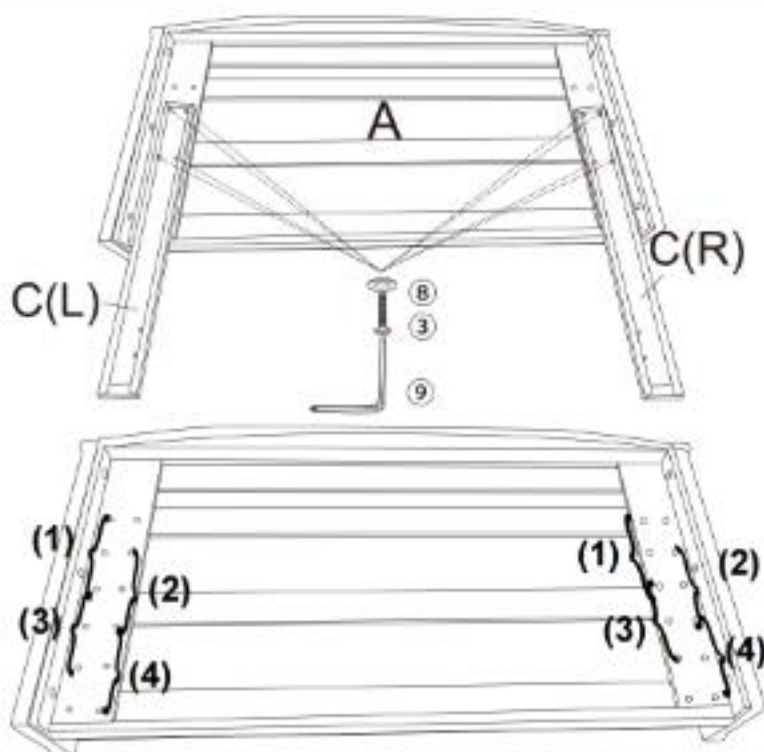

For the convenience of installation, please lock 50% of all screws in this step, and then lock 100% after step 3 is completed

Part C(L) and Part C(R) is installed onto Part A as shown in the figure.

And there are four installation methods to adjust the height of the bed.

Adjustable bed height range: 1.2m-1.5m (manual measurement: ± 2 cm)

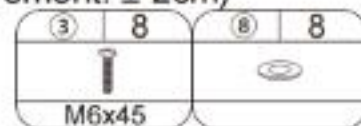

3

ASSEMBLY INSTRUCTION

3



NO!

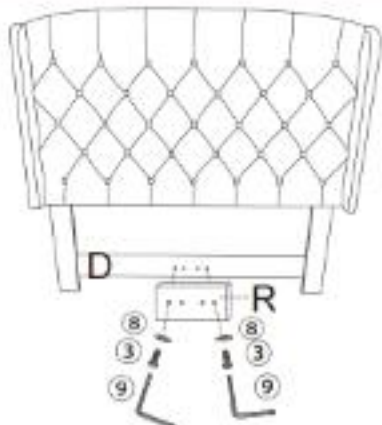

When installing the Part D, pay attention to distinguish between the front and the back.
There are two holes in the middle of the front.

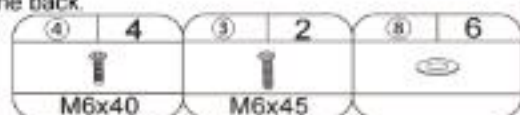

4

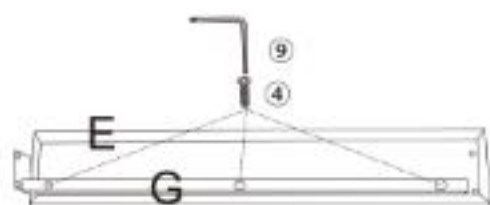

✓

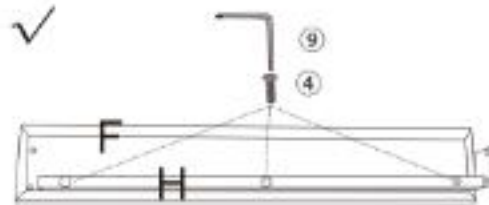

X2

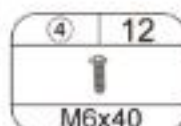

NO! X

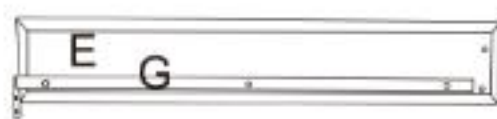
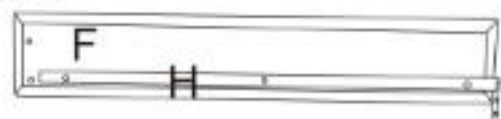

5

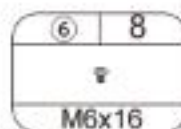
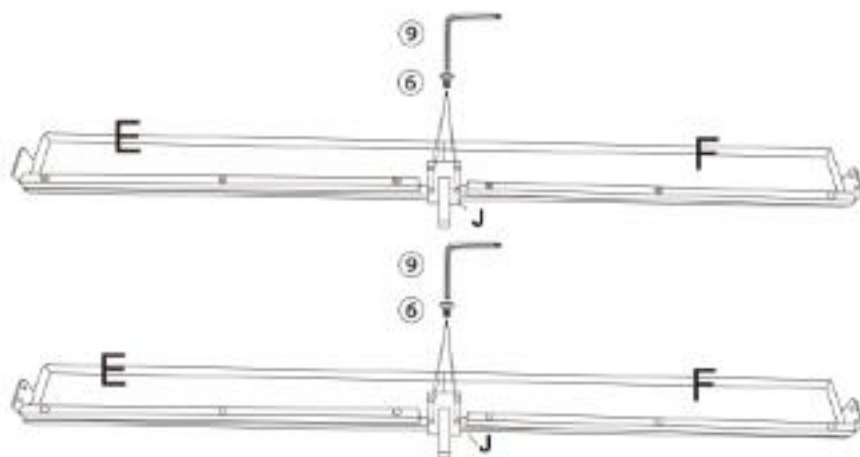

4

ASSEMBLY INSTRUCTION

6

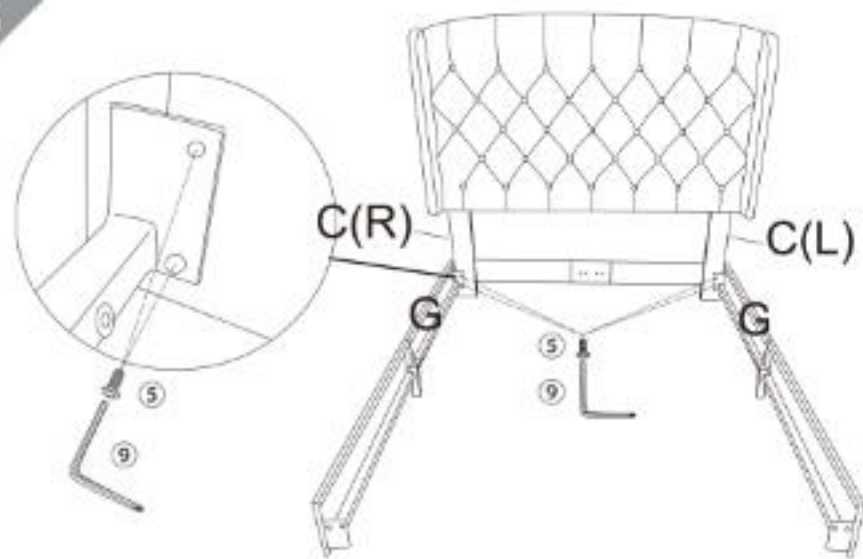

5	4
T	
M6x30	

7

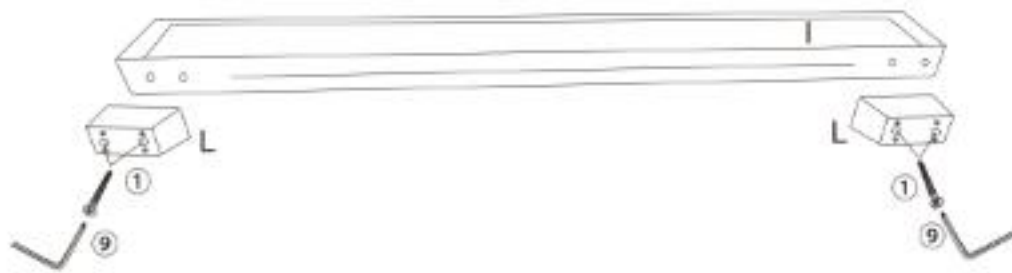

1	4
T	
M4x55	

8

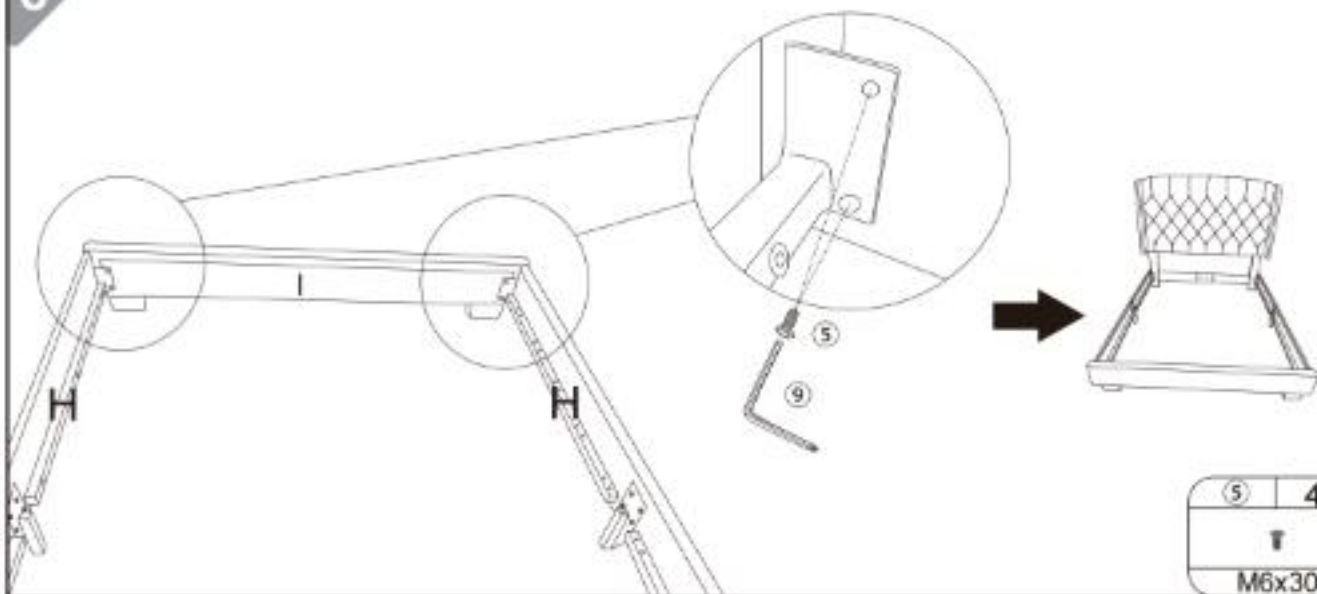

5	4
T	
M6x30	

5

ASSEMBLY INSTRUCTION

9

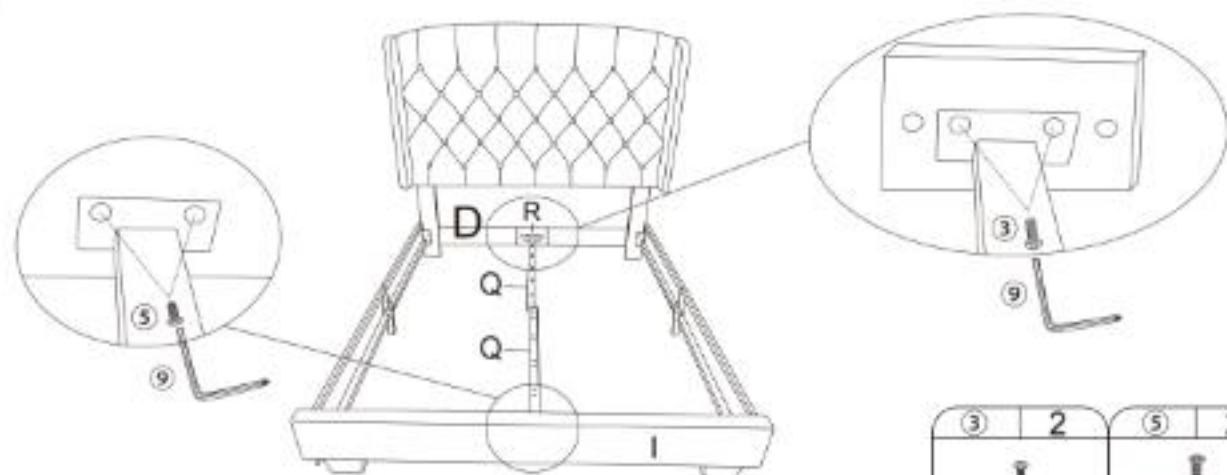

③	2	⑤	2
v		f	
M6x45		M6x30	

10

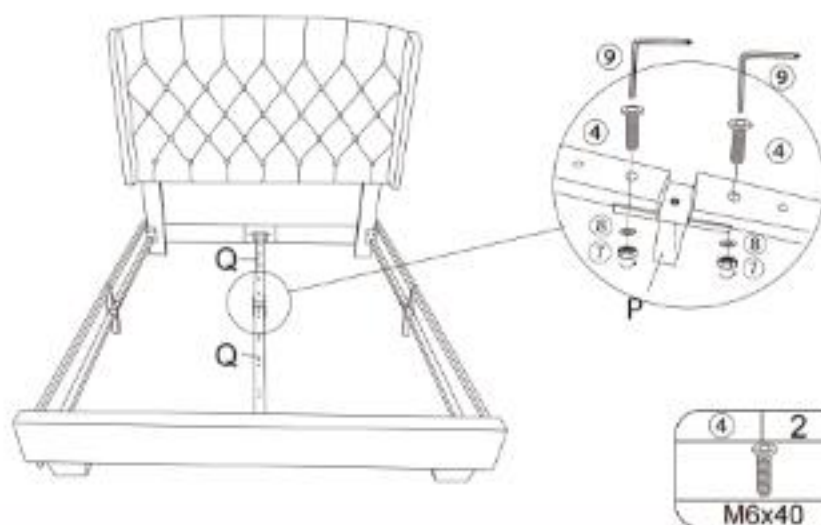

④	2	⑧	2	⑦	2
M6x40		(washer)		(nut)	

11

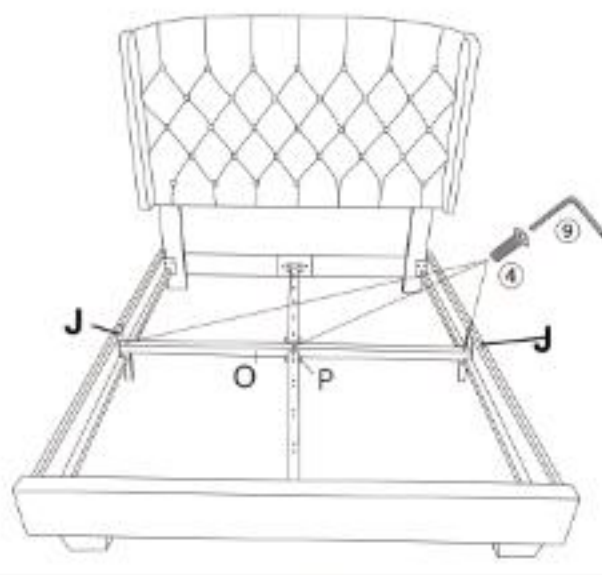

④	3
M6x40	

6

ASSEMBLY INSTRUCTION

12

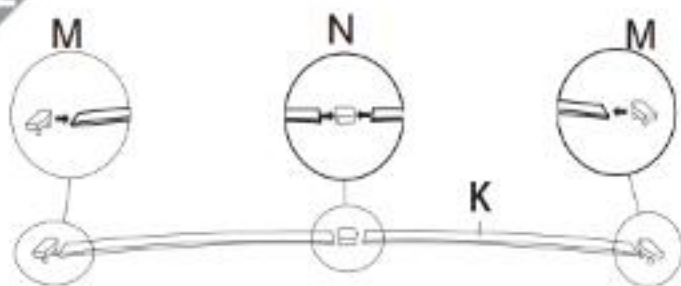
**X10**

NO!

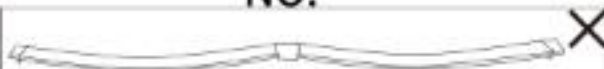

13

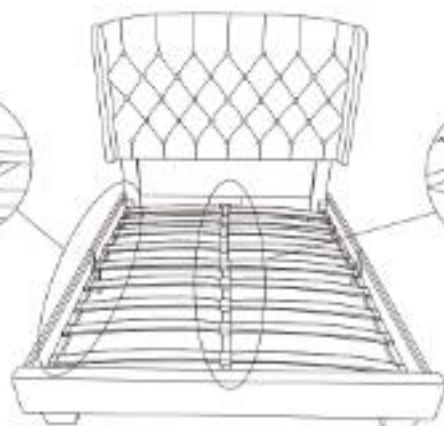
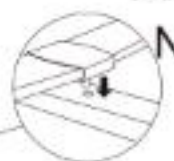
Attention:
on the sideAttention:
on the middle

14

