

Operating Instructions

Caution: You must read this before you proceed

Chair

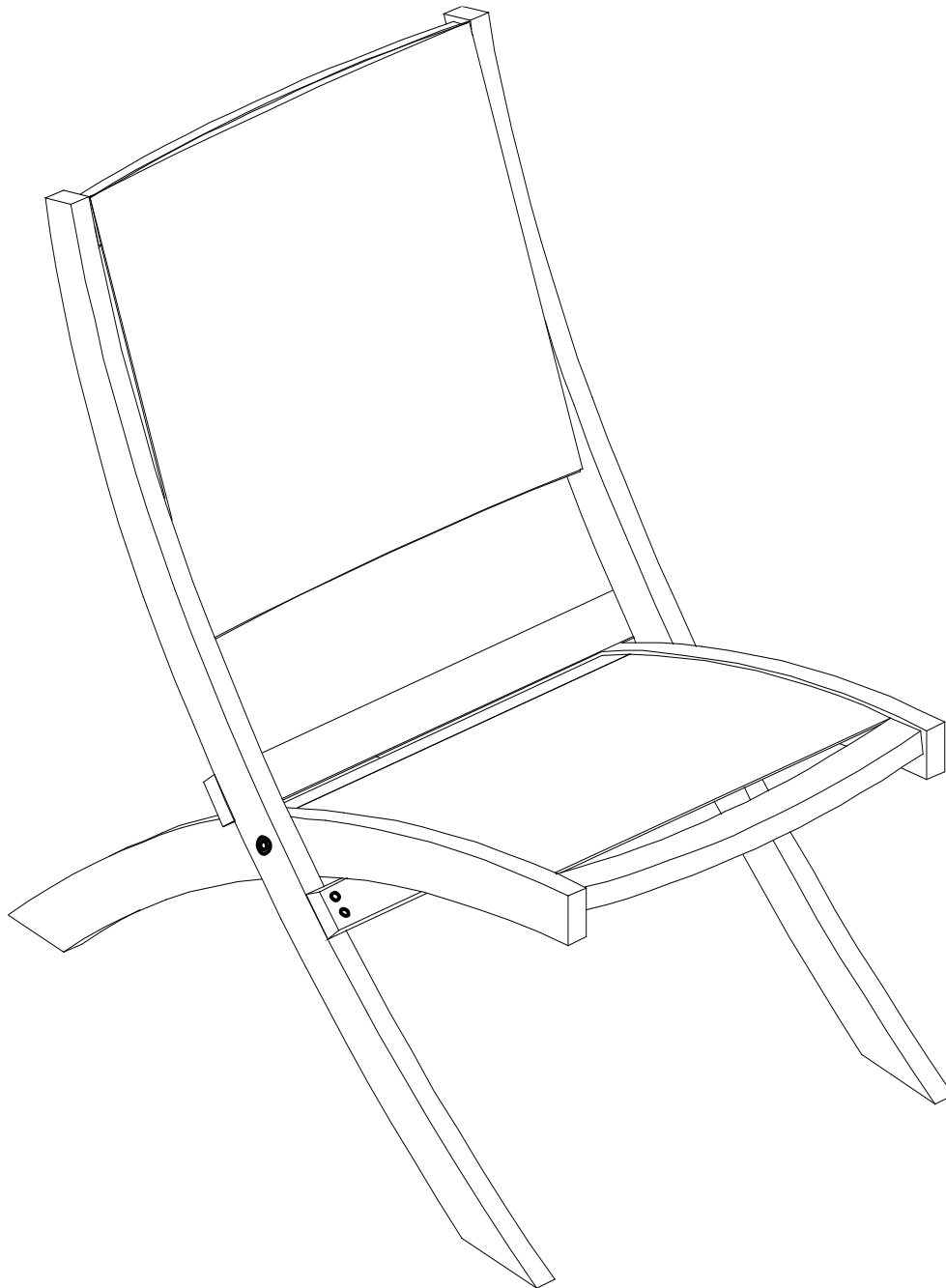

Caution: This Chair is NOT a TOY.
Keep your child/children at bay when opening or folding the Chair.

Operating Instructions

Step 1

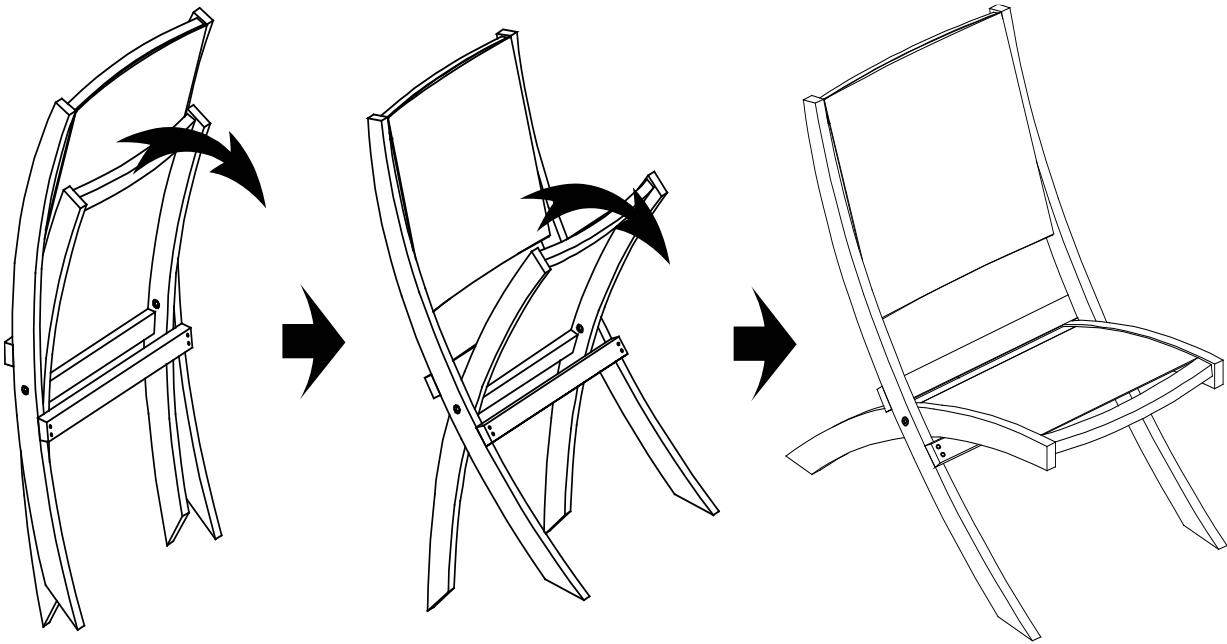

Position the Chair as pictured.

To open:

Pull the Seat forward with one hand and steady the chair with your other hand.
Unfold Leg Frame as indicated by the arrows, until the Chair folds out and locks into position.

Step 2

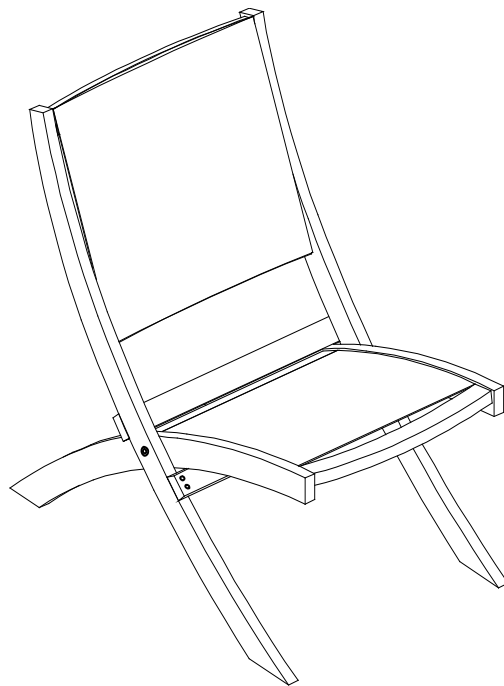

Your Chair is ready for use.

This Chair can only be used on a flat, level surface.



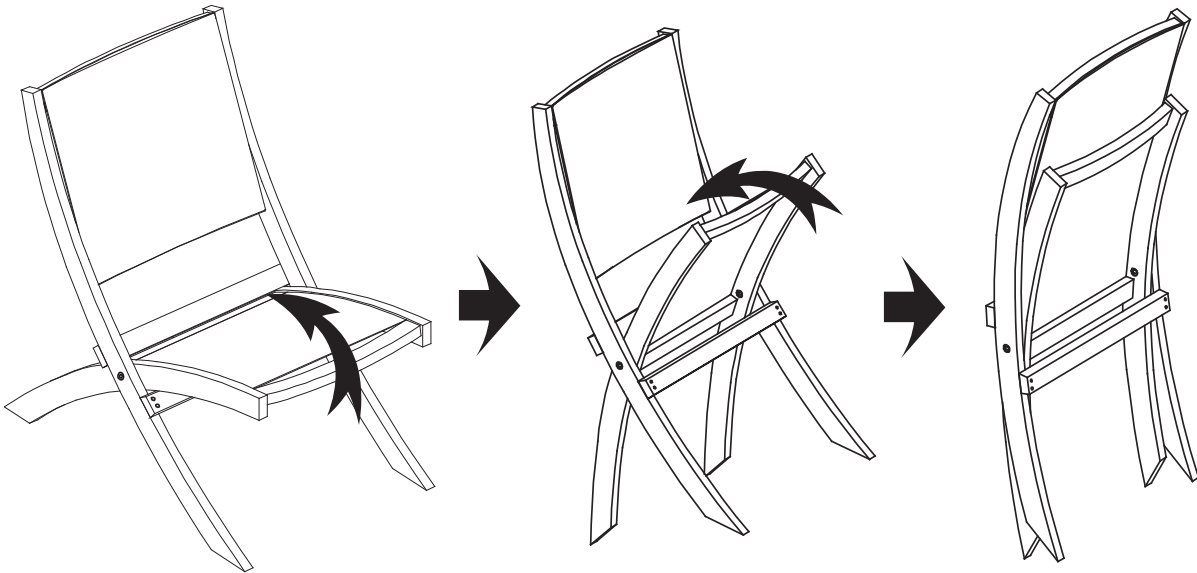

















Step 3



To close:

Pull the Seat up and fold the Leg Frame as indicated by the arrows.

Care & Maintenance

-   ● Do not put hot items directly on furniture surface
 -   ● Do not clean furniture with harsh cleansers or polish.
 -   ● To obtain the longest lifespan of your outdoor products, minimizing exposure to direct sunlight is recommended.
 -   ● Children should not climb or jump on the furniture.
 -   ● Do not write on furniture without a padded barrier to protect the surface.
 -   ● To obtain the longest lifespan of your outdoor products, avoid extended and lengthy exposure to rain, snow, and direct sunshine. Whenever possible cover the product and /or place under patio or awnings.
 -   ● Not for commercial use. For residential use only .
 -   ● Stains may be removed with mild soap solution and damp cloth.
 -   ● Keep away from sources of ignition.
-
-   ● Dust and pick-up spills using a clean, non-colored, lint-free cloth.