















SKU:ZY-8062

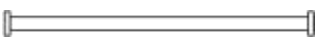

CONTENTS

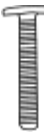
1. Contents
 2. Fitting list and Assembly Instructions
 3. Usage Information
 4. Tips
 5. Maintenance And Warning
 6. Contact Details
-

FITTING LIST

<p>Ax1</p>  <p>Base</p>	<p>Bx1</p>  <p>Backrest</p>	<p>Cx2</p>  <p>Armrest 1 Armrest 2</p>		
<p>Dx1</p>  <p>Backrest Pillow</p>	<p>Ex1</p>  <p>Cushion</p>	<p>Gx1</p>  <p>Head support pillow</p>		
<p>Hx2</p>  <p>Armrest pillow</p>	<p>Ix1</p>  <p>Ottoman Base</p>	<p>Jx1</p>  <p>Ottoman top</p>		
<p>Kx1</p>  <p>Turntable</p>	<p>Lx2</p>  <p>Iron rod</p>			
<p>Mx4</p>  <p>M6x20 mm</p>	<p>Nx8</p>  <p>M8x20 mm</p>	<p>Ox14</p>  <p>M8x40 mm</p>	<p>Px14</p>  <p>φ 8x22mm</p>	<p>Qx1</p> 

ASSEMBLY INSTRUCTIONS

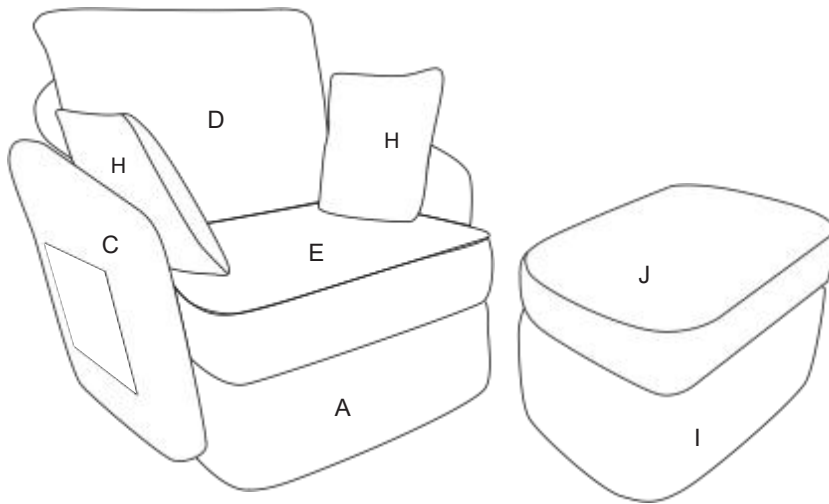

STEP 1

Please take out the C-armrest and A-base, and install them as shown in the picture. Also find the B-backrest and insert it between the two armrests.

Please note: Wait until the screws in step 2 are aligned before tightening all the screws.

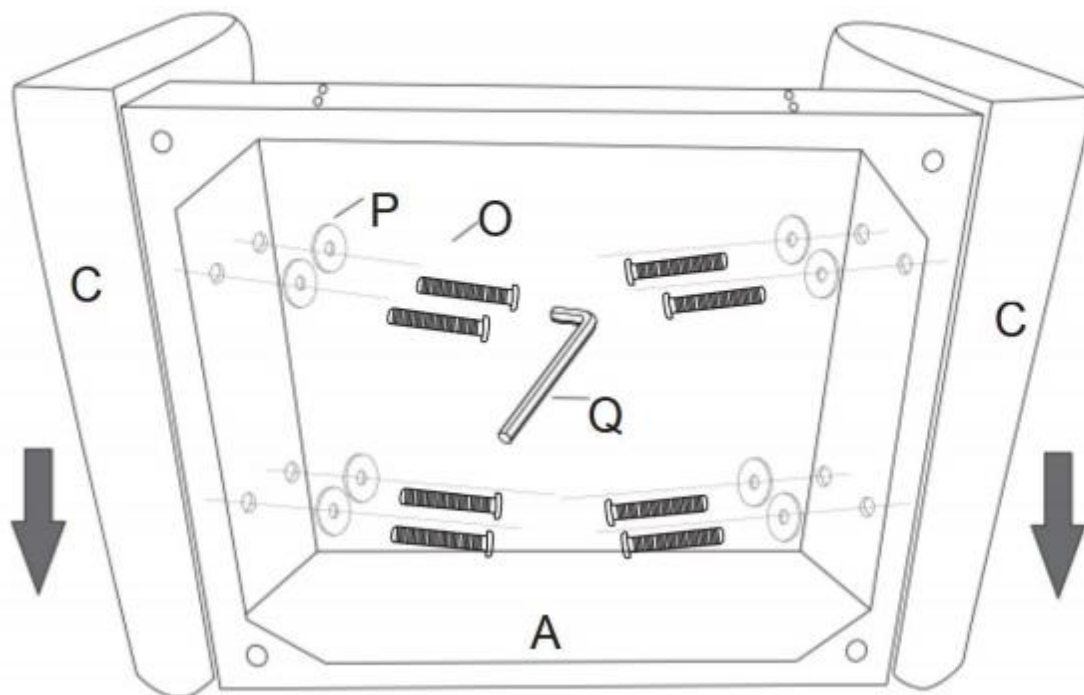

STEP 2

Open the backrest curtain and install the armrest and backrest with screws as shown in the figure. Please tighten all screws on the base, armrests and backrest. Make sure none of them are loose.

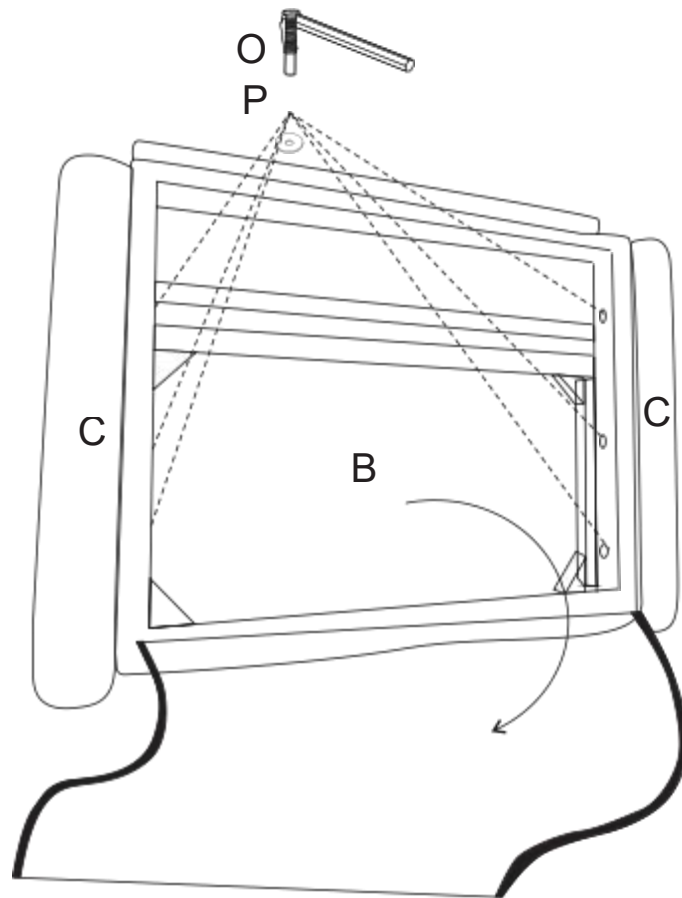

STEP 3

Please take out the L-iron rod and install it to the bottom of the base with screws.

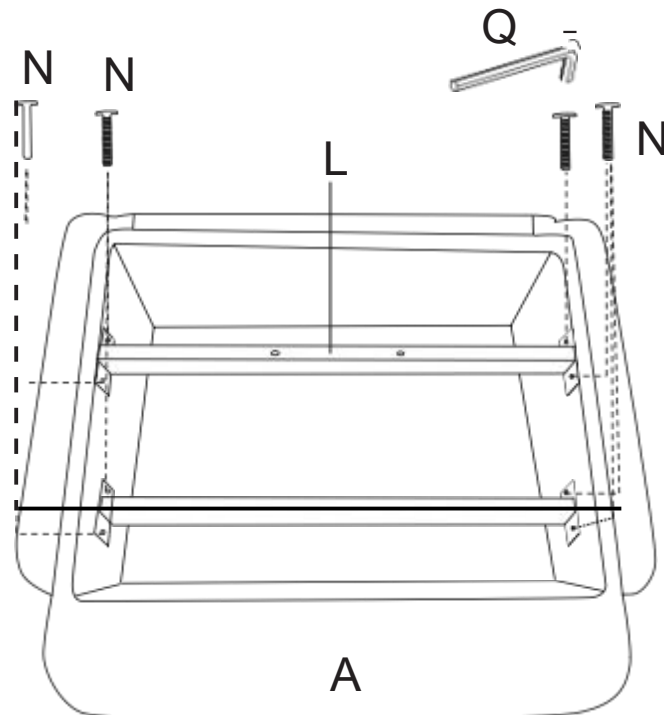

STEP 4

Please take out the K-turntable and install it on the iron rod. Please tighten the screws to prevent it from loosening.

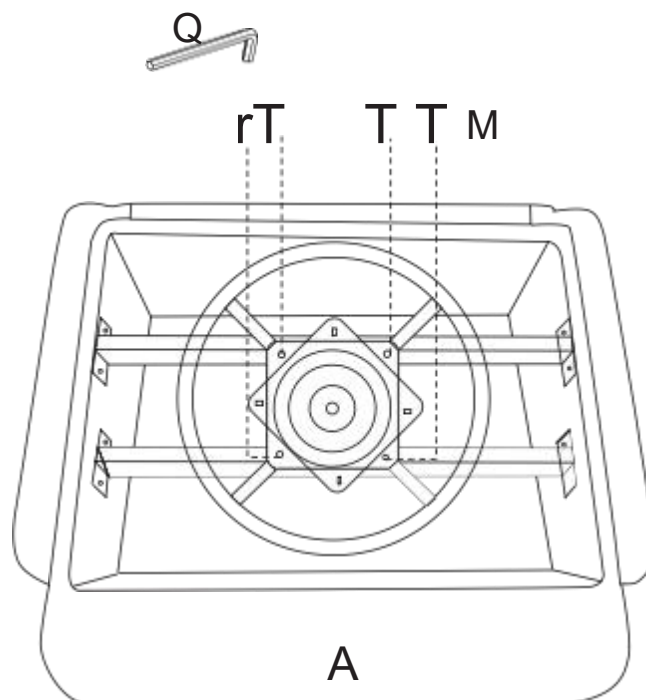

STEP 5

Please take out the G-head support pillow and zip it up with the B-backrest.

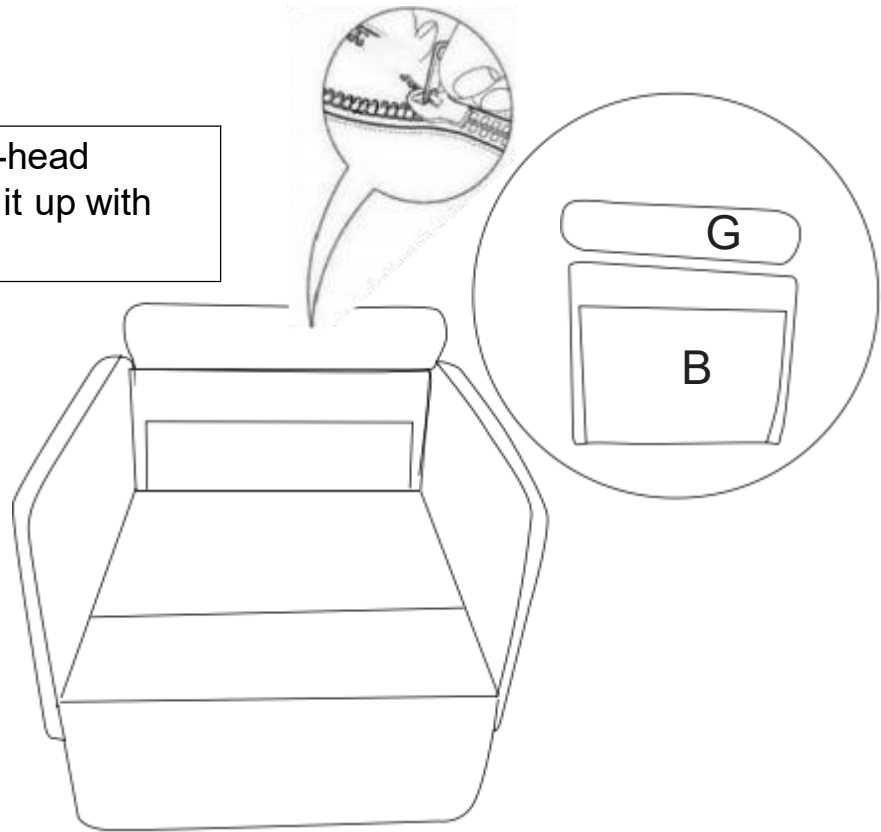

STEP 6

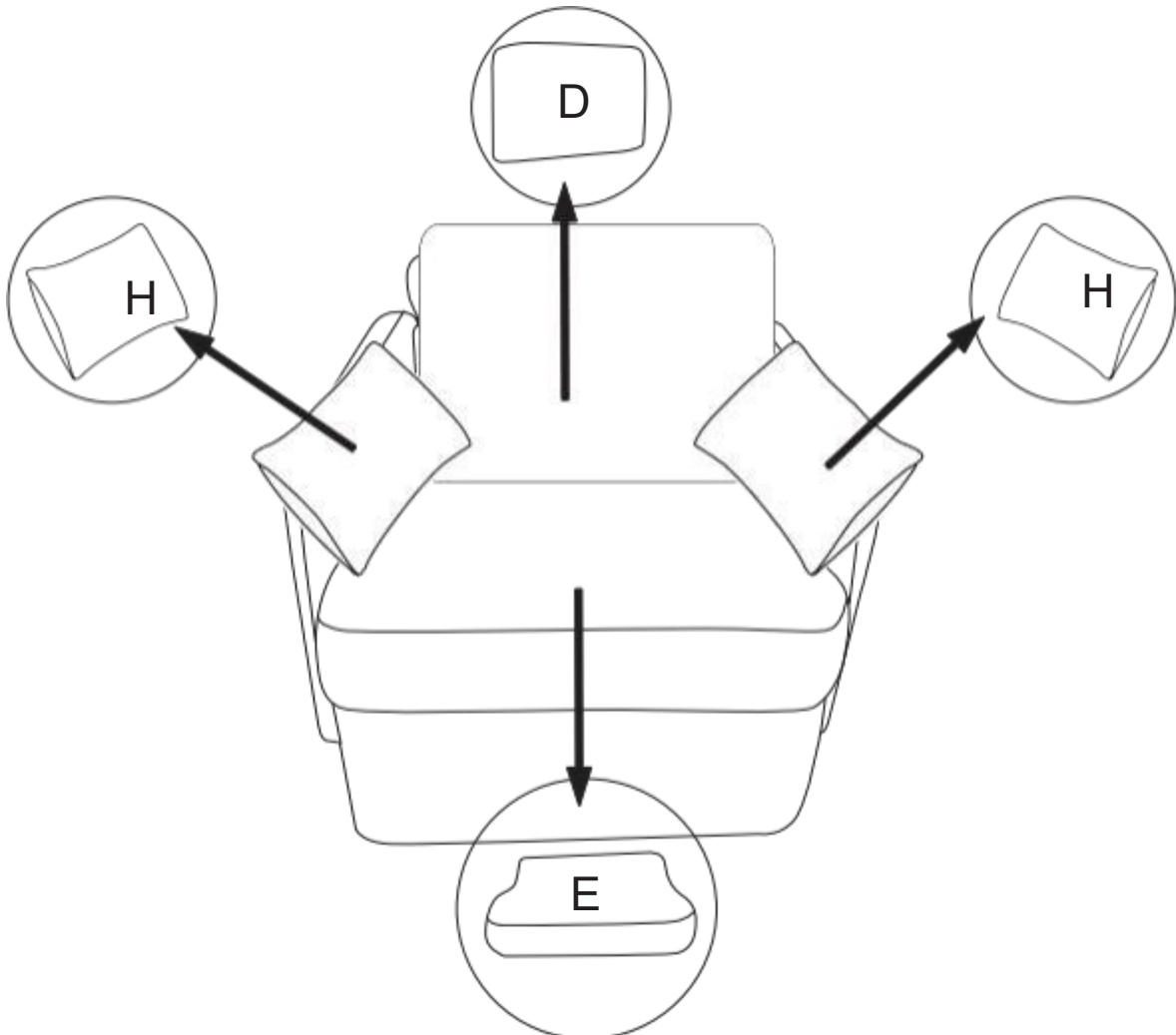

Ottoman is placed behind the backrest.

STEP 7

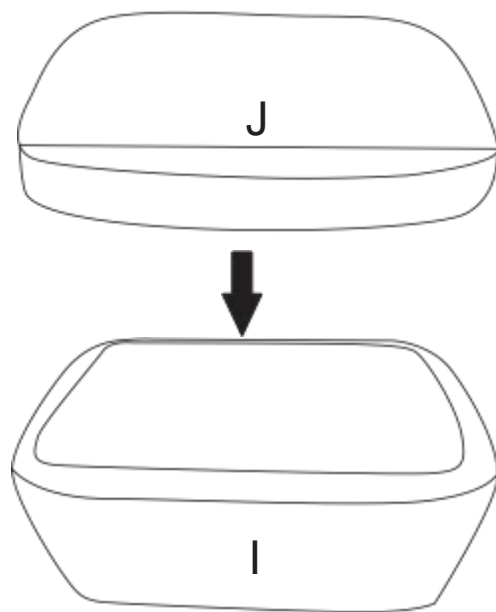

STEP 8

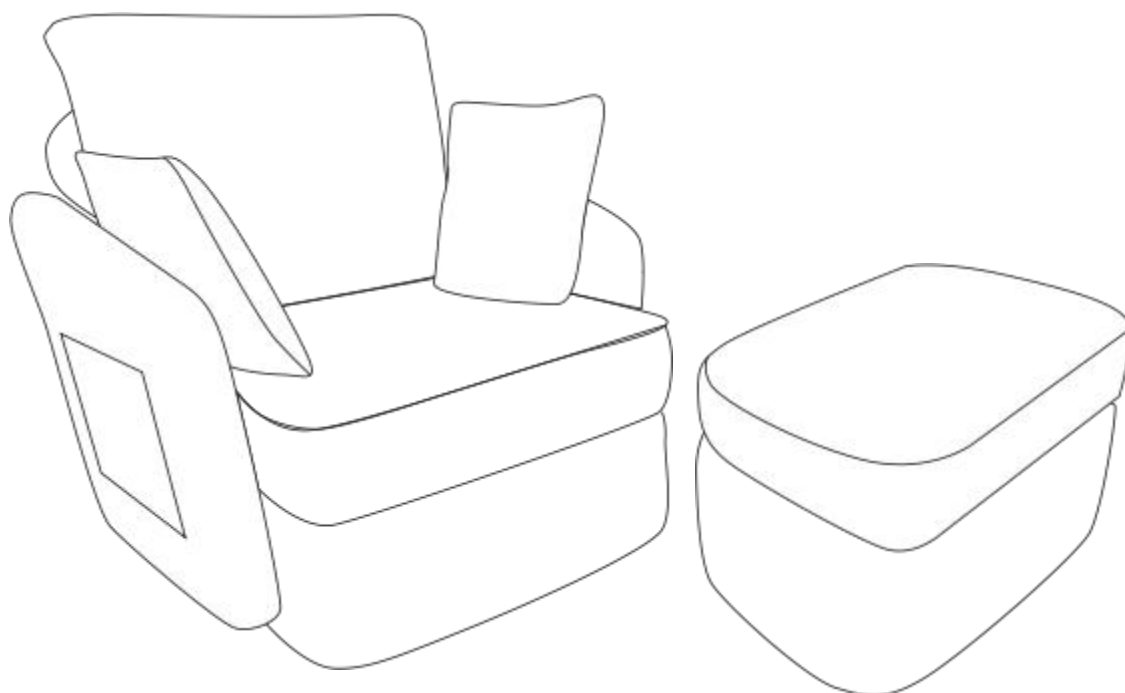

Tips:

1. Due to differences of light effects, the actual color of the materials might be slightly different from the pictures.
2. Due to package compression for better shipment, the fabric may have wrinkles.
3. Please take all packages out and pat every part to make it rebound better and fluffy, so that it can restore to picture-like status.
4. Please keep children away from the plastic bags.

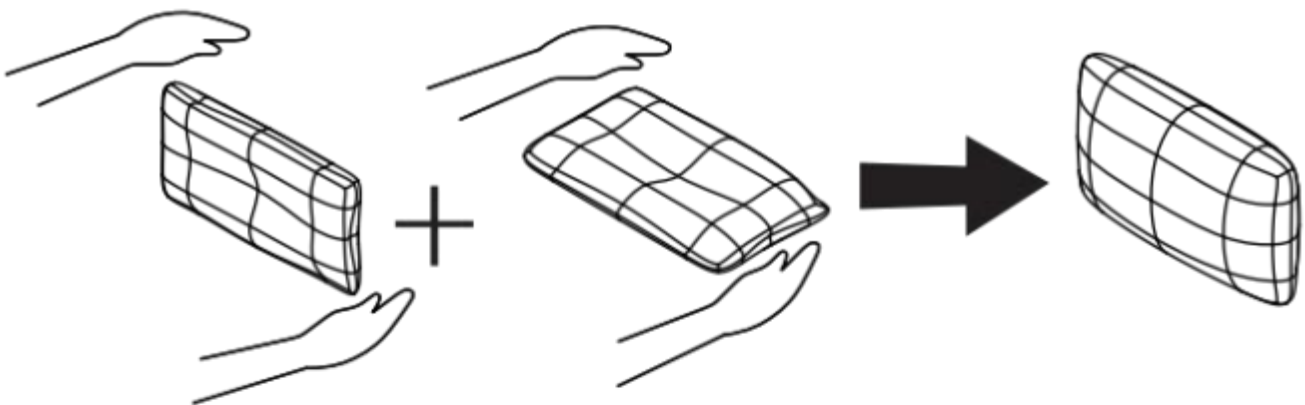

- 1.Repeatedly tap the sides and front and back to make it rebound better and fluffy.
- 2.Knead your cushion like giving your cushion a massage while allowing the air to flow through the foam.



48-72h

It might takes up to 48-72 hours.

MAINTAINANCE AND WARNING

- 👉 Keep furniture away from heat.
- 👉 Do not clean furniture with harsh cleansers or polish.
- 👉 Do not use detergents, Solvents, abrasives, spray packs or leather cleaner.
- 👉 Use non-color mild soap with warm water clean
- 👉 Do not use on site dry Cleaning machine.
- 👉 Children should not climb or jump on the furniture.
- 👉 Do not write on furniture without a padded barrier to protect the surface. Not for commercial use, For residential use only.
- 👉 spills(Mix 1:10 soap to water) Do not place furniture under direct sunlight, material will possibly fade over time.

*Are you having difficulty
with assembly? Missing parts?*

*Please send email with your order No to
lovestars1231@outlook.com*

*For return, please check the return policy with the
retailer or market place you bought from.*

*Appreciate your purchasing from us. Pop
up your life by our furniture piece!*