

HAPPINESS HAPPINESS INSTALLATION



CAUTION

Parts are placed at the bottom of the product.

- If you have any questions with the product, please contact us by:
- **Email: customerservice@zoy-living.com**
(we will reply to you within 24 hours)

Assembly Instructions





CAUTION

DO NOT use any sharp objects to open plastic wrapped components as this may result damage to product or components .

Model: CD0224NF

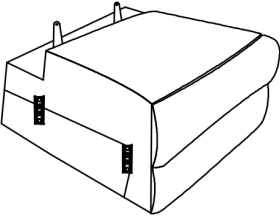
Your recliner comes packaged in **Two** box. Carefully remove all of components from the packaging and set aside for assembly.

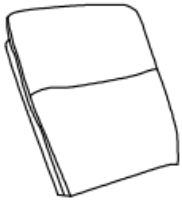
Package Contents

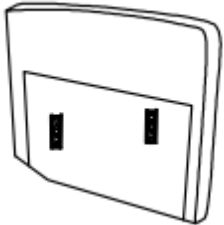
BOX 1 CD0224NF51D				
	A*1	B*1	C*1	
BOX 2 CD0224NF51D				
	D*1	E*1	F*1	

1 RECLINER ASSEMBLY - BODY SETUP

Step 1 :

Remove all parts from the bottom of the sofa, check if they are complete, and then intact

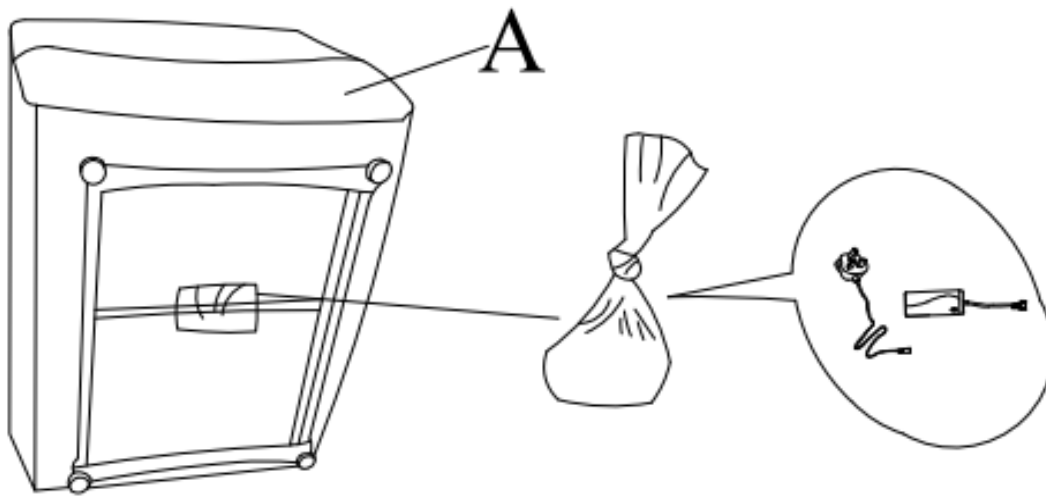

Step 2:

Insert two Armrests(E&F) to the Seat(A), make sure the slots on the Armrests fully assembled to the bottom part.

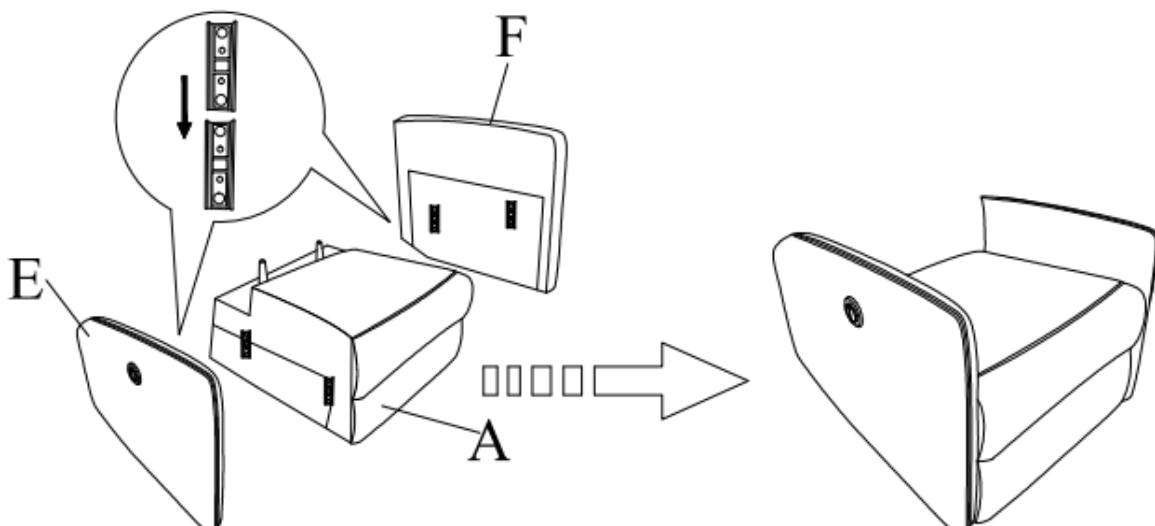

2 RECLINER ASSEMBLY - BODY SETUP

Step 3:

Install the **Chair Back (D)** on the Seat via metal slot to ensure a tight connection without wobbling.

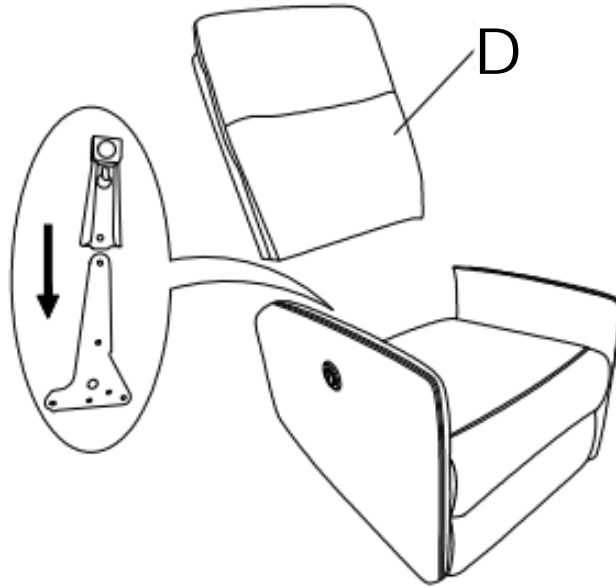

Step 4:

Finally, connect the power supply and power cord as shown in the diagram (B&C).

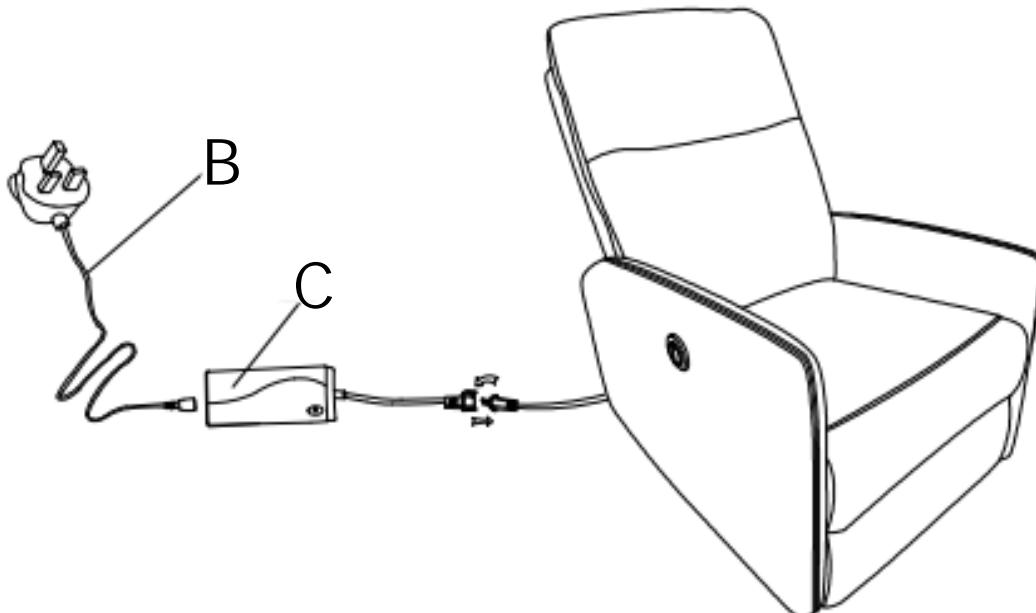

3 INSTRUCTIONS FOR USE - SIZE DIMENSIONS

ASSEMBLY COMPLETED

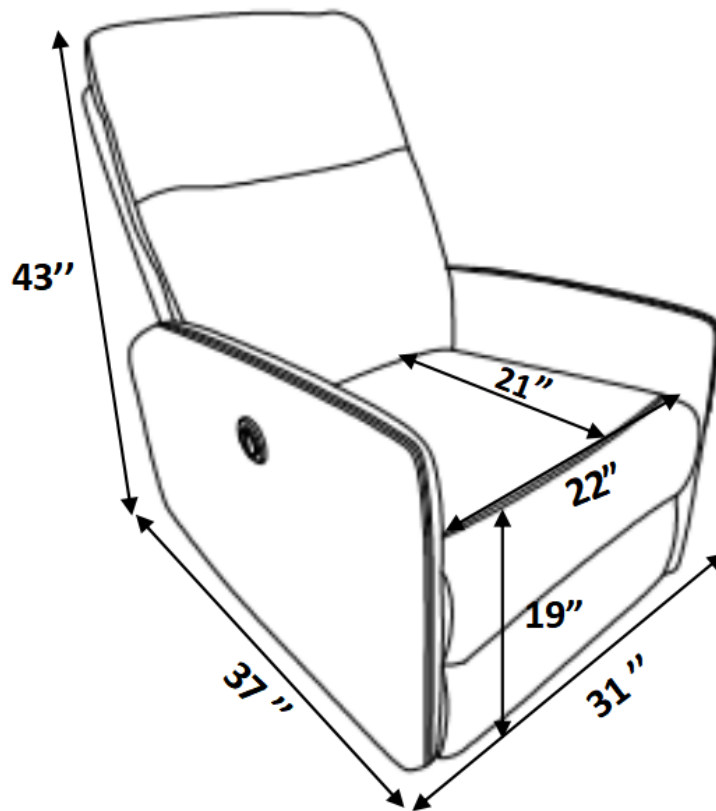

Recliner Chair

CD0224NF51D

⚠️ WARNINGS

1. Please check if the components of the chair are all included and can be used normally.
2. Assemble all components according to the instruction correctly before you connect the chair to the power.
3. Please DO NOT sit on the armrests or footrest to eliminate the risk of tipping over.
4. If the chair is damaged or doesn't match the website description, please send clear pictures of the product and label of the carton to our service team for further help.
5. If you have any questions about our products, please contact us by:

Email: customerservice@zoy-living.com (we will respond to your inquiry within 24hours)

