

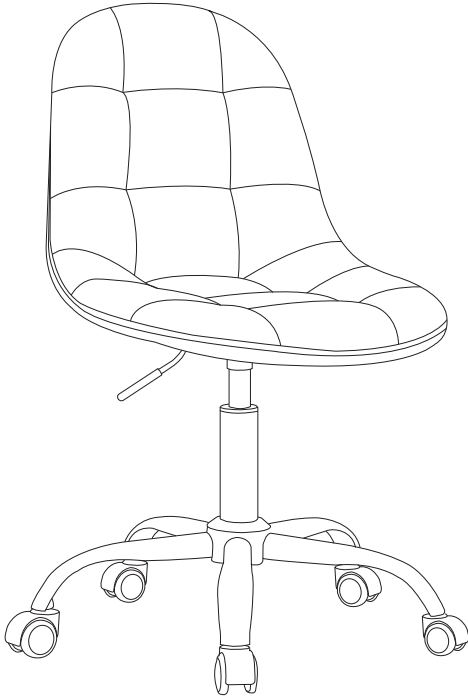





# Assembly Instruction

**Tips!**

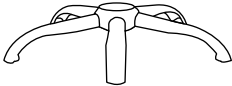
Check all the components & screws before assembly. Do not install in case part is missing, contact us



Components		
A	 Gas Lift	×1
B	 Star Base	×1
C	 Caster	×5
D	 Seat with pipe	×1
E	 Catch	×1

**Return Policy**

We believe you will absolutely love your new item. But if for some reason you want to return, please contact us directly before you decide to return your product. Our customer service organization can answer most concerns and assist you with any questions you may have about your new item.

The item must be returned within 30 days of delivery for a full refund. The item must be returned in good condition, in original box, with all original proof of purchase, parts and accessories.

**Trouble shooting:**

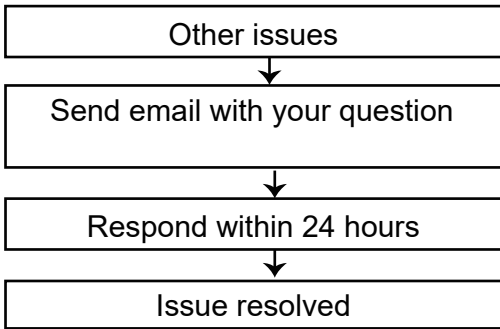
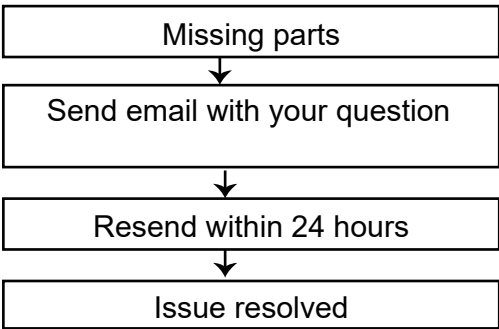

We control manufacturing and distribution ourselves, ensure the quality.

1

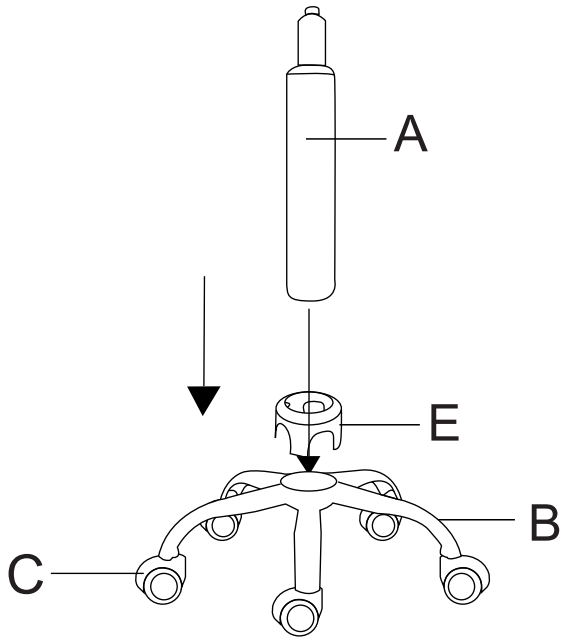

1. Find base(B); Install wheels(C) under base(B); Install decoration ring(E) and hydraulic bar(A) on base(B).

2

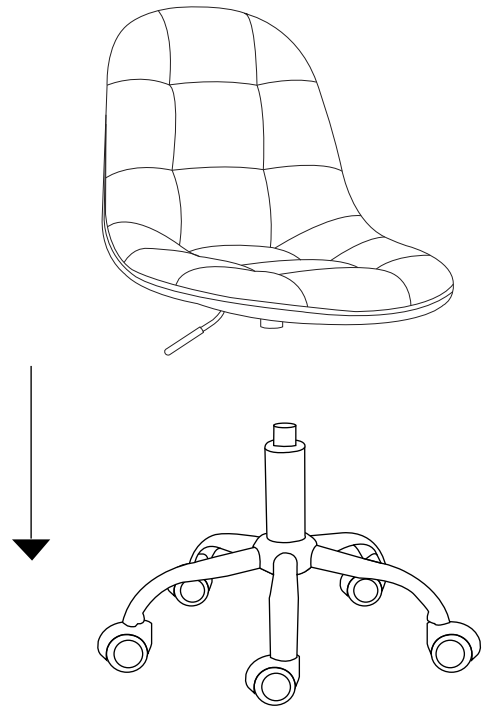

2. Install seat(D) on hydraulic bar(A) which is already fixed on base(B)

3

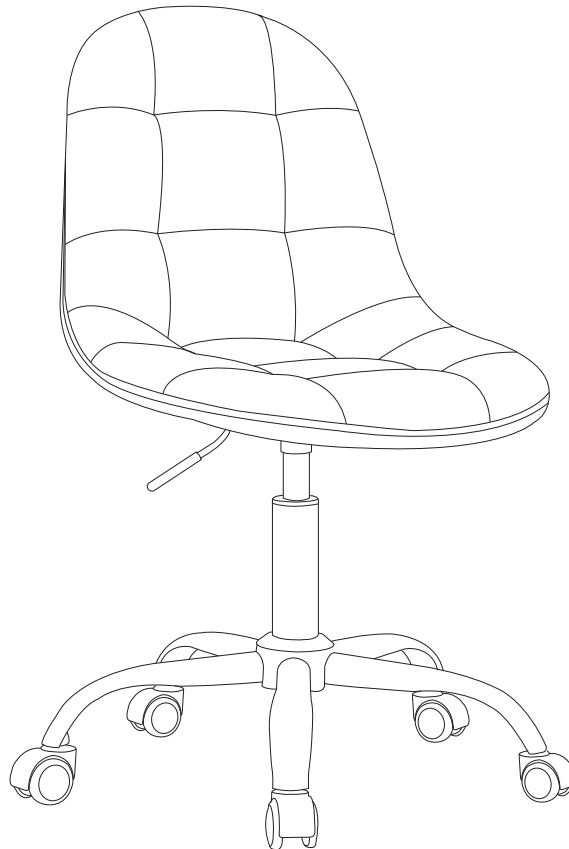

3. Finished.