

Assembly Instructions

CAUTION: You must read this Assembly Instructions before you proceed.

Please look under the Seat Panel for hardware pack.

CHAIR

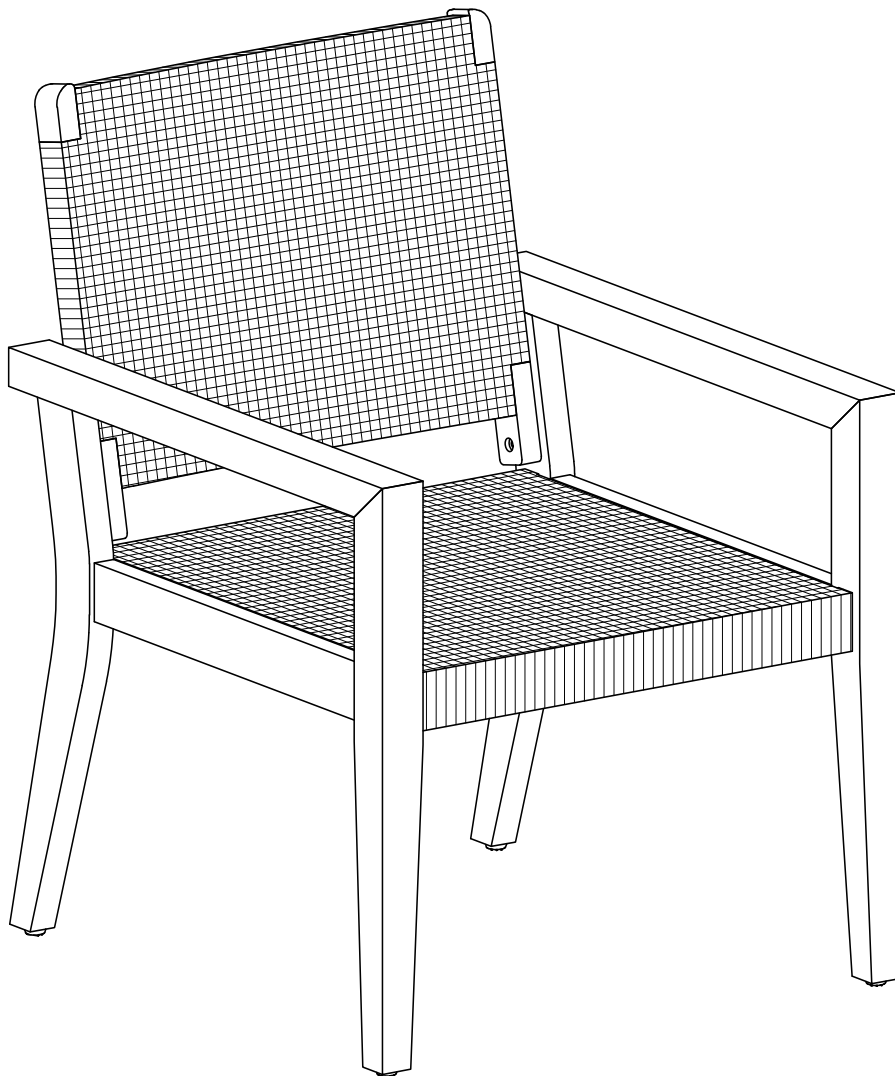

CAUTION: This Chair is NOT a TOY.



Keep your child / children at bay in the process of assembly.

For turning the Chair and to prevent damage to the Chair, 02 persons may be needed to execute this action.

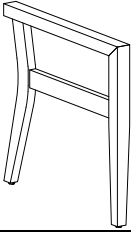
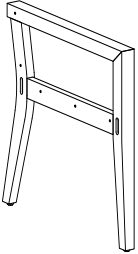
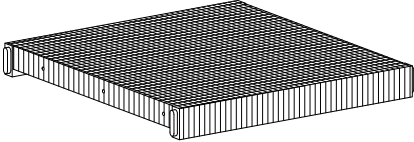
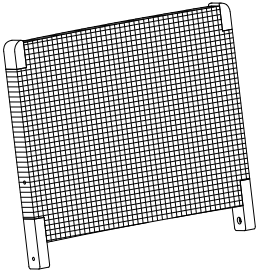
Parts List

Label	Picture	Description	QTY
A		Left Side Panel	1
B		Right Side Panel	1
C		Seat Panel	1
D		Backrest Panel	1

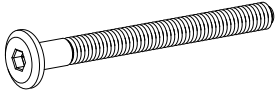
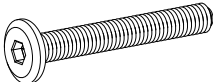
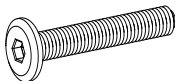
Hardware

Label	Picture	Description	QTY
①		Long Bolt (M6x65mm)	3
②		Medium Bolt (M6x45mm)	5
③		Short Bolt (M6x40mm)	5
④		Washer (Ø6.5x20x2mm)	3
⑤		Allen Wrench (K4)	1

Assembly Preparation

Before Beginning Assembly:

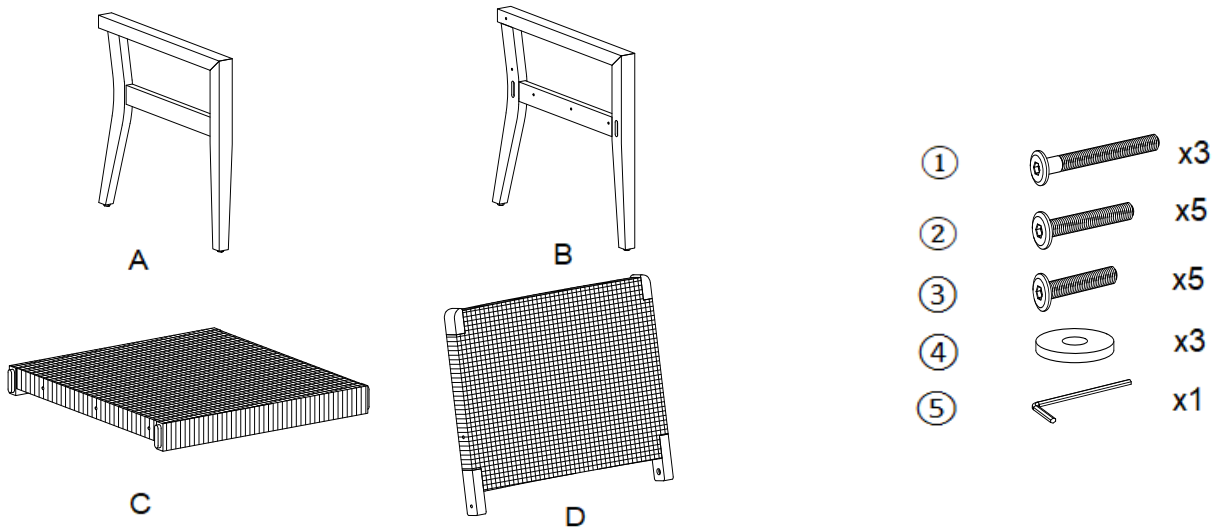

- Read instructions, cover to cover-



- Have 2 adults on hand for assembly-



- Do not assemble on flooring or carpet-



- Assemble on a clean non-marring surface (packing foam)-



- Save all packaging until finished-

Assembly steps

Overview

Backrest Panel (D)

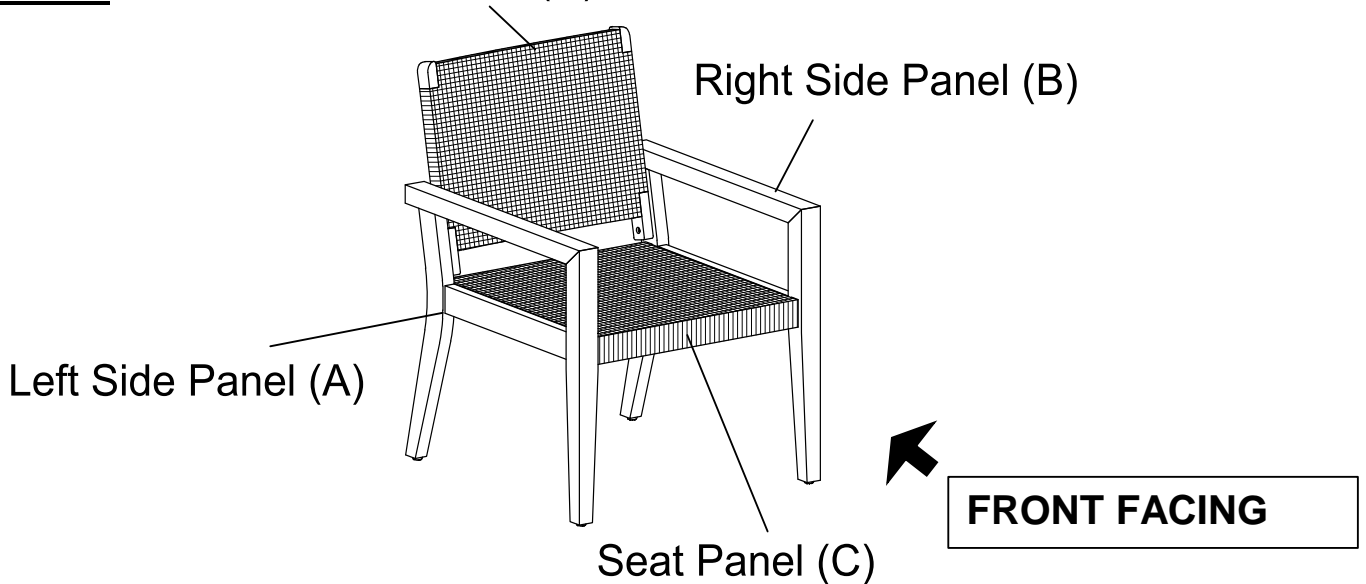

This Chair has multiple parts and may require up to 30 minutes to assemble. To give you an overview of the Chair parts, the above picture is to help you put the various parts into perspective. Please read through the instructions below to familiarise yourself with the parts and steps before assembly.

Step 1

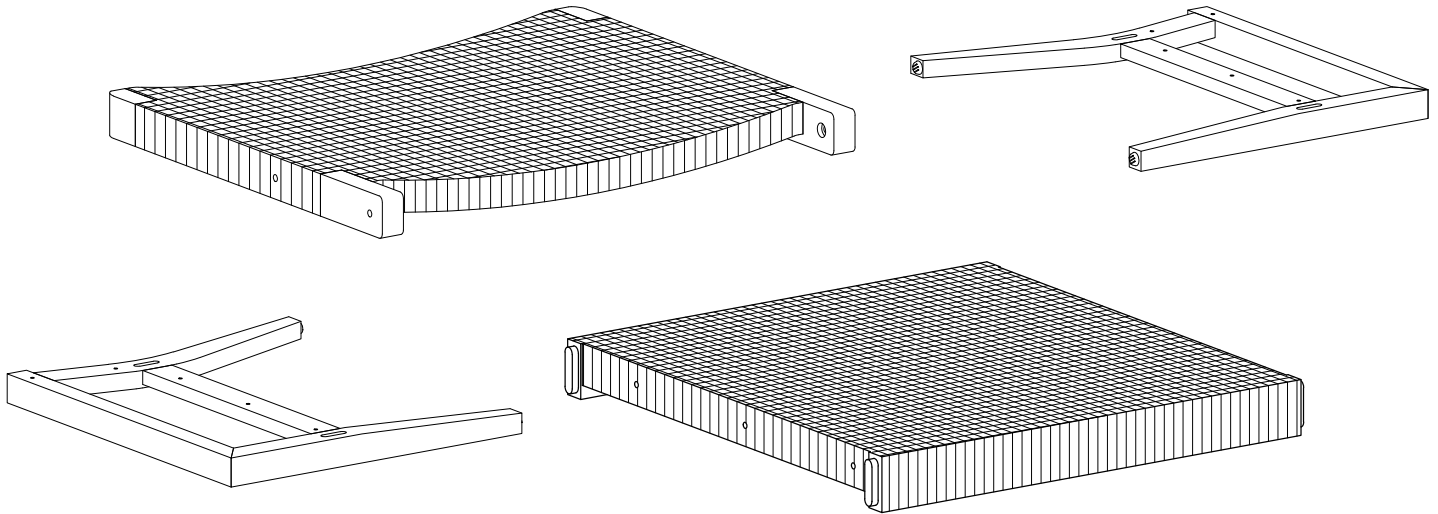

Unpack and place all parts on a clean, non-marring surface.

Step 2

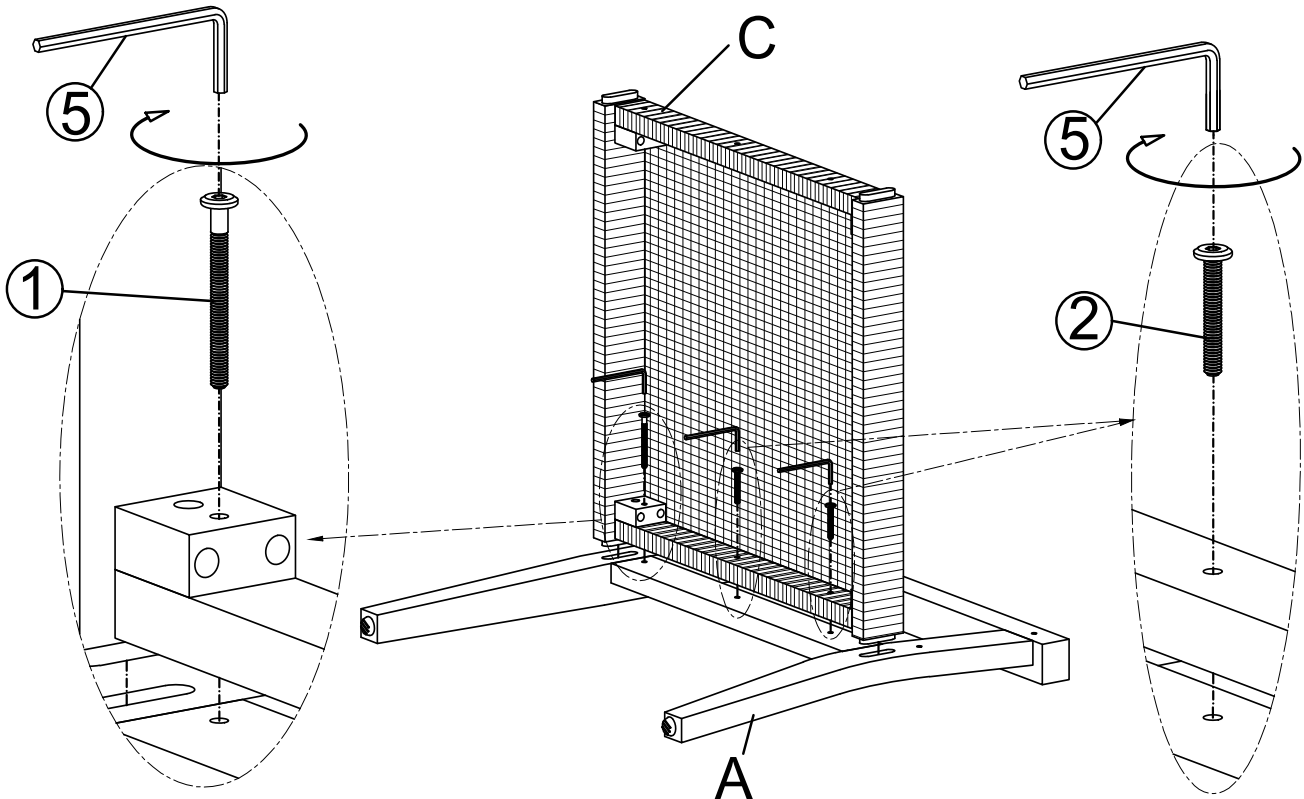

Place the Left Side Panel (A) facedown on a clean, non-marring surface as shown above.

With assistance from your adult partner, attach the Seat Panel (C) to the Left Side Panel (A) using Bolt (1), Bolt (2) and the Allen Wrench (5) as shown above.

DO NOT fully tighten the Bolts.

Step 3

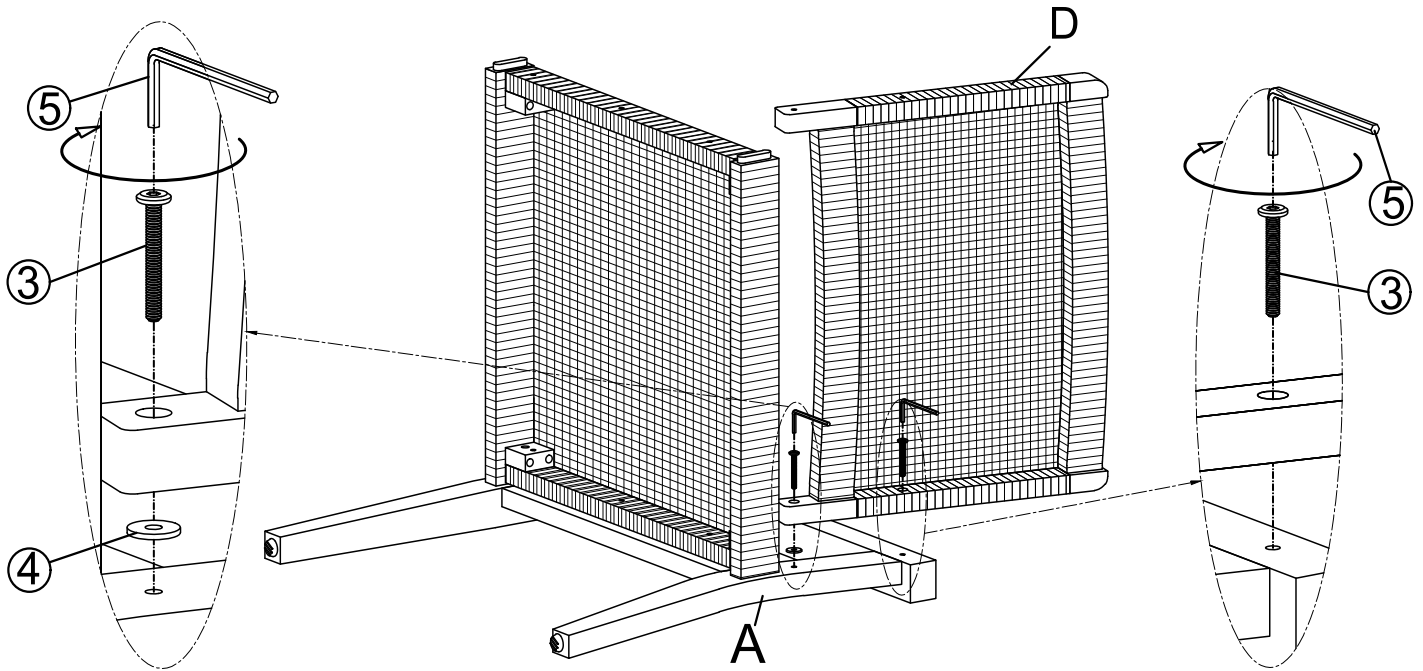

With assistance from your adult partner, attach the Backrest Panel (D) to the Left Side Panel (A) using Bolt (3), Washer (4) and the Allen Wrench (5) as shown above.

DO NOT fully tighten the Bolts.

Step 4

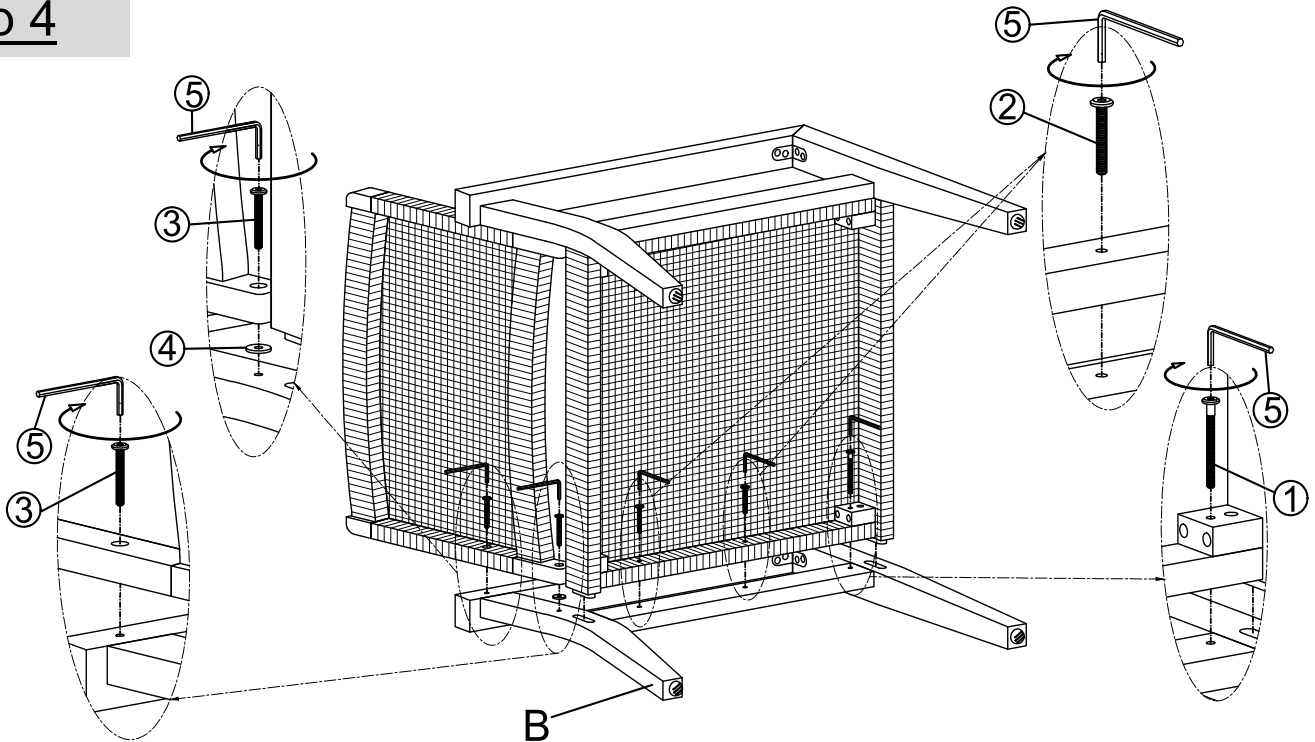

With assistance from your adult partner, attach the assembled part from step 3 to the Right Side Panel (B) using Bolt (1), Bolt (2), Bolt (3), Washer (4) and the Allen Wrench (5) as shown in the picture above.

Do not fully tighten the Bolts.

Step 5

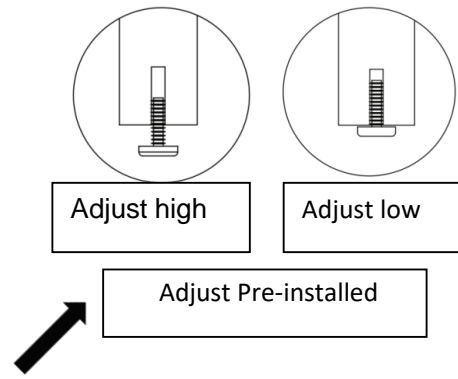
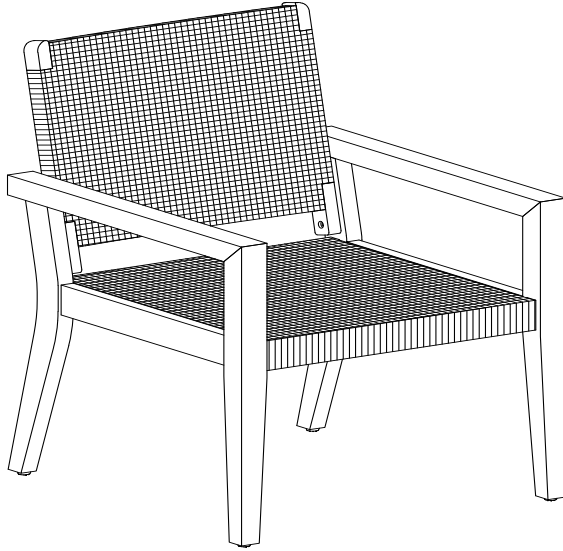

Turn the Chair right side up.

EXERT pressure, floorwards onto the Chair with both hands.

This pressure will help the Chair reach full alignment at all joints.

Check for wobbles.











Inspect the Chair and make sure all parts are adequately connected.

In a sequential manner, tighten ALL Bolts at ALL joints.

Your Chair is ready to be used.

This Chair can only be used on a flat, level surface.

Care & Maintenance

-  ● Do not put hot items directly on furniture surface
-  ● Do not clean furniture with harsh cleansers or polish.
-  ● To obtain the longest lifespan of your outdoor products, minimizing exposure to direct sunlight is recommended.
-  ● Children should not climb or jump on the furniture.
-  ● Do not write on furniture without a padded barrier to protect the surface.
-  ● To obtain the longest lifespan of your outdoor products, avoid extended and lengthy exposure to rain, snow, and direct sunshine. Whenever possible cover the product and /or place under patio or awnings.
-  ● Not for commercial use. For residential use only .
-  ● Stains may be removed with mild soap solution and damp cloth.
-  ● Keep away from sources of ignition.
-  ● Dust and pick-up spills using a clean, non-colored, lint-free cloth.