

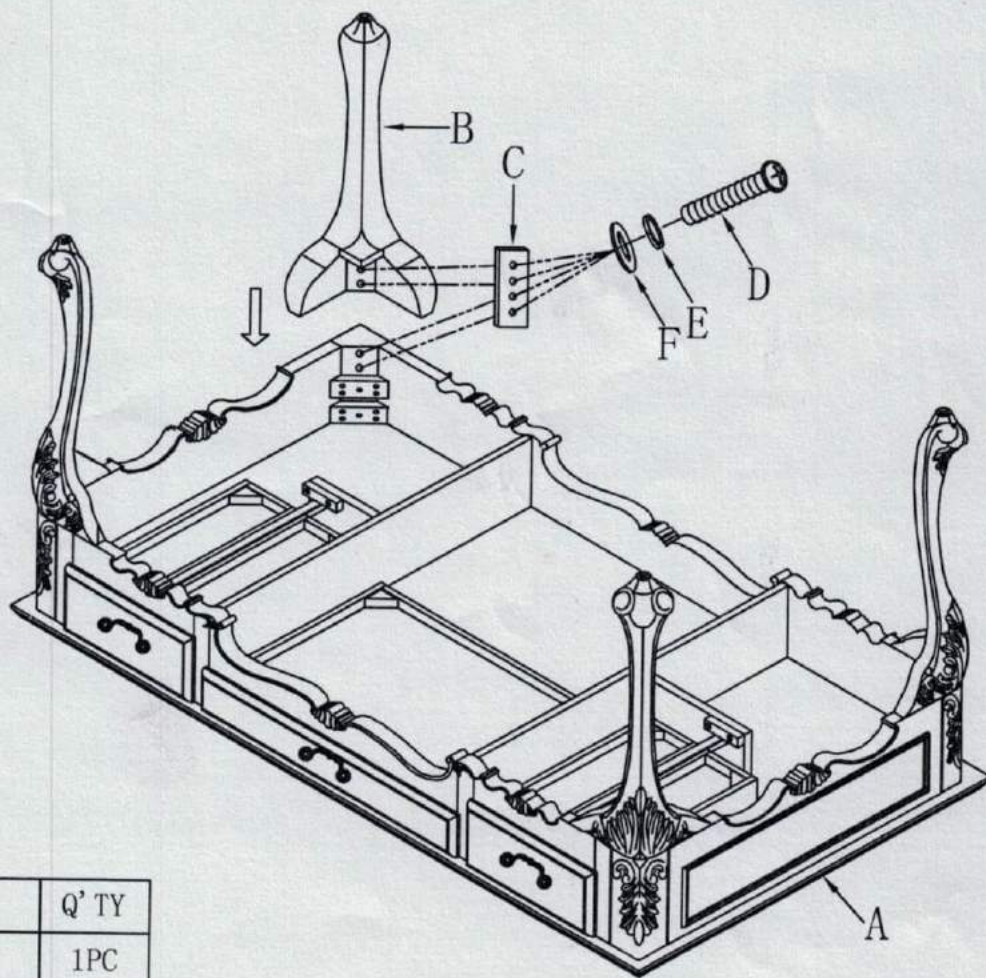

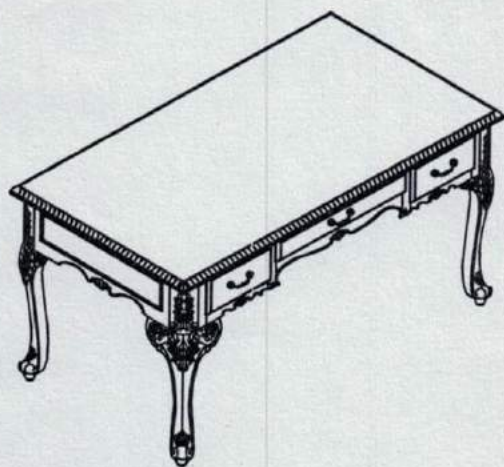



ASSEMBLY INSTRUCTION

Small Burl Desk

* DO NOT TIGHTEN SCREWS UNTIL COMPLETELY ASSEMBLED



NO	HARDWARE LIST	Q' TY
A		1PC
B		4PCS
C		4PCS
D	 $\phi \frac{5}{16}'' * 1 \frac{3}{4}''$	16PCS
E	 $\phi \frac{5}{16}''$	16PCS
F	 $\phi \frac{5}{16}''$	16PCS