

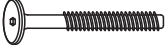









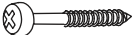



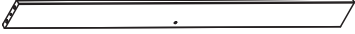



# ASSEMBLY INSTRUCTIONS

## Alexander Platform Bed-Full

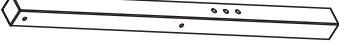
Avoid using sharp objects such as a knife to cut open packing as you may accidentally damage the item.

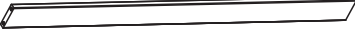
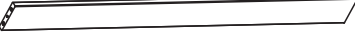
### PARTS LIST

ITEM	DESCRIPTION	SKETCH	QUANTITY
HW1	Screw : 1/4x70mm		8x
HW2	Dowel : 10x40mm		22x
HW3	Screw : 4x30mm		12x
HW4	Screw : 7x90mm		6x
HW5	Allen Key		1x
HW6	Screw : 7x60mm		5x
HW7	Elliptical Nut : 1/4x25mm		8x
A	Bed Footrest		1x
B	Bar		2x
C	Left Foot		1x
D	Right Foot		1x
E	Slat		2x
F	Central Foot Support		1x
G	Center Foot		3x
H	Right foot headboard		1x
I	Left foot headboard		1x
J	Headboard Top Cross Bar		1x
K	Narrow central headboard bar		1x
L	Central headboard bar		1x
M	Headboard Lower Crossbar		1x

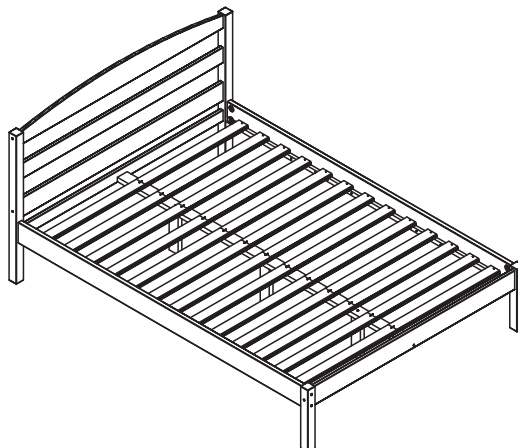

# ASSEMBLY INSTRUCTIONS

Do not fully tighten bolts until assembly is complete.

## Step 1

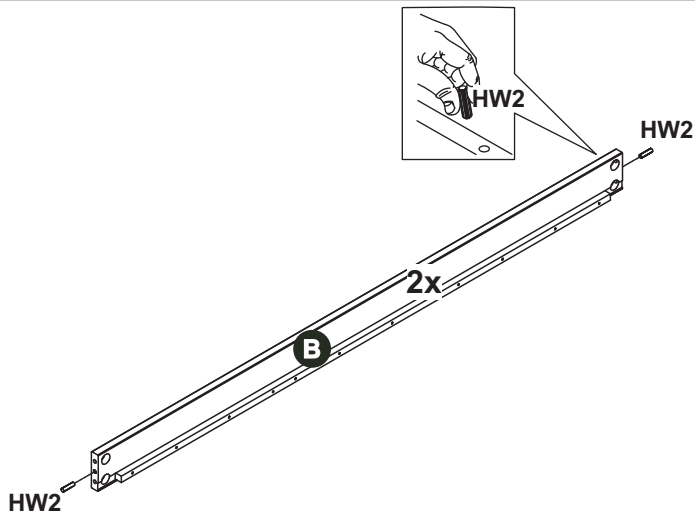

Step 1: Insert the dowels HW2 in parts B

## Step 2

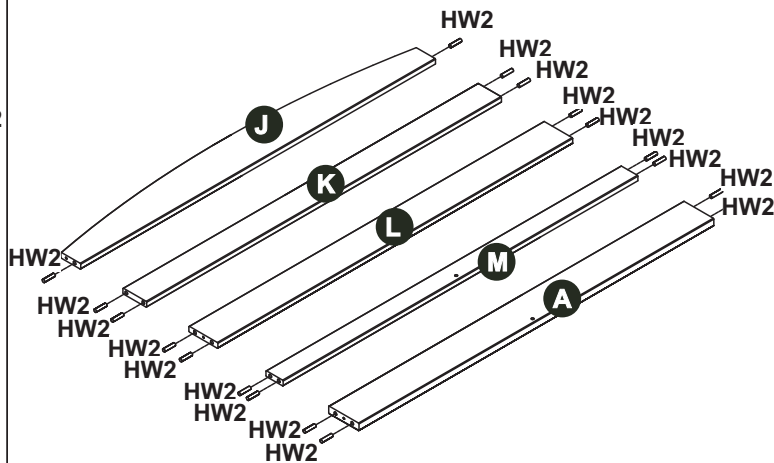

Step 2: Insert the dowels HW2 in parts A, J, K, L and M.

## Step 3

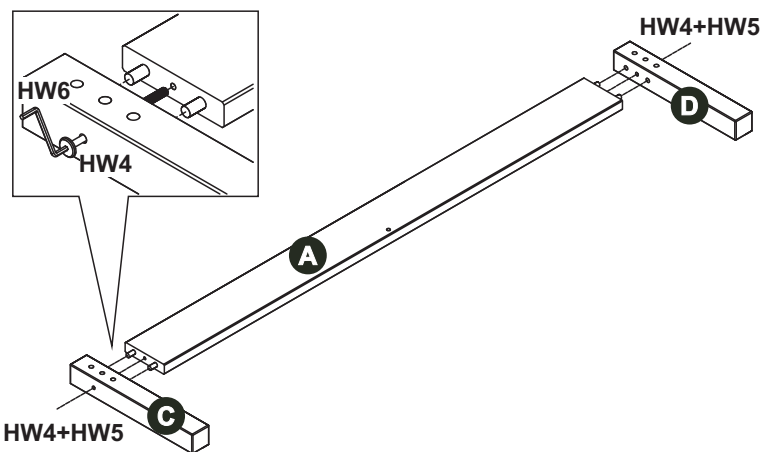

Step 3: Join crosspiece A with feet C + D with HW4 screw and HW5 spanner

## Step 4

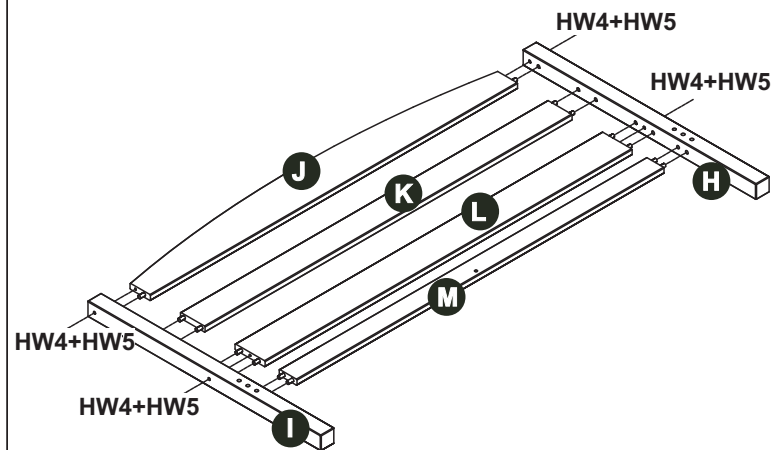

Step 4: Join crosspiece J, K, L and M with feet H + I with HW4 screw and HW5 spanner

## Step 5

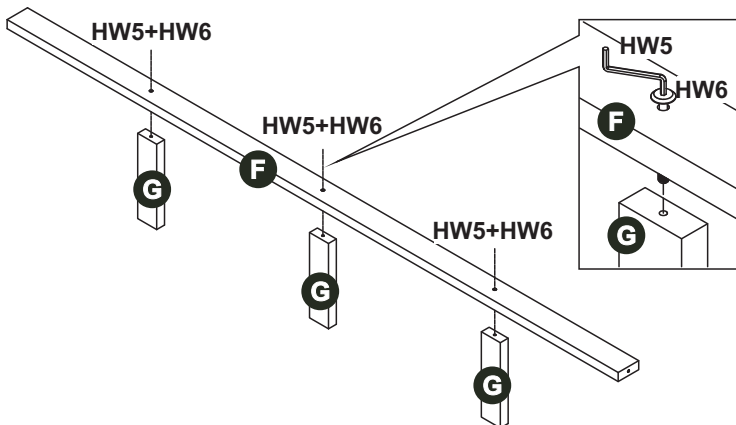

Step 5: Join piece F + G with screw HW6 and key HW5

## Step 6

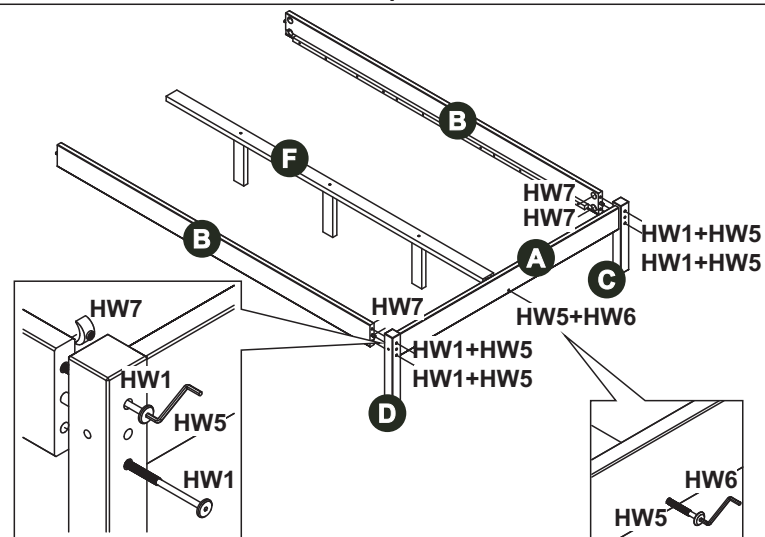

Step 6: Join mounted footboard A with bars B, use screw HW1 with HW5 wrench and HW7 nut  
Fix the support F with screw HW6 and key HW5

# ASSEMBLY INSTRUCTIONS

Do not fully tighten bolts until assembly is complete.

## Step 7

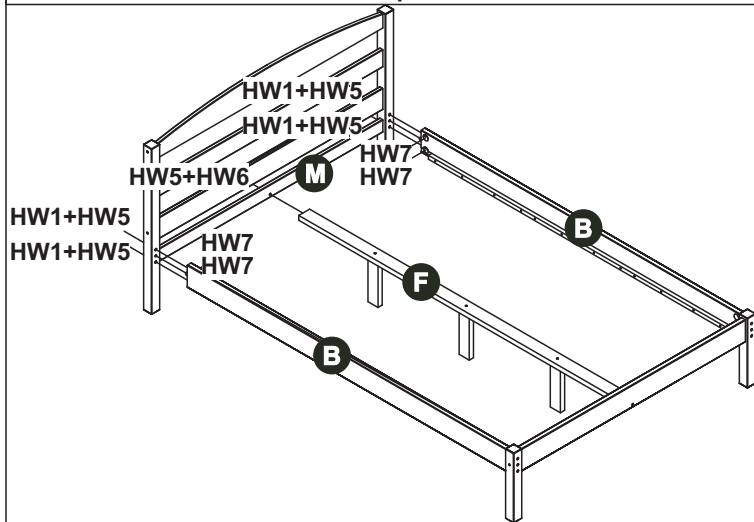

Step 7: Join mounted headboard M with bars B, use screw HW1 with HW5 wrench and HW7 nut  
Fix the support F with screw HW6 and key HW5

## Step 8

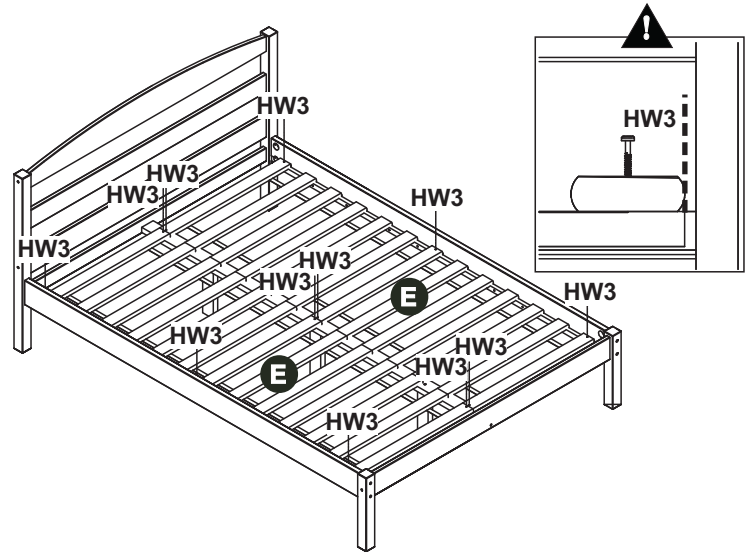

Step 8: Fit the platforms E and fix with screws HW3

**CLEANING INSTRUCTIONS:** Clean with Soft cloth, brush, or lightly vacuum.

## ADULT ASSEMBLY REQUIRED

If you are missing any parts or have any questions regarding assembly, do not return this item to the retailers store. Please call our toll-free, customer service number and have this assembly manual open to the parts list ready to provide the model name, number and part name or number.



## Customer Service

1-877-864-5752

8:30 AM PST - 4:00 PM PST (Monday-Friday)

Website: [www.dwellhom.com](http://www.dwellhom.com)

Missing Parts: [parts@dwellhom.com](mailto:parts@dwellhom.com)

Warranty Information: [www.dwellhom.com/warranty](http://www.dwellhom.com/warranty)

**WARNING:** This product may contain small components, please ensure they are kept away from small children.