







ASSEMBLY INSTRUCTION

HARDWARE LIST

Item	Description	Drawing	Pcs
A	Bolts M8*16		4
B	Spring washer Ø13		4
C	Flat washer Ø20Ø8		4
D	Allen wrench 5mm		1

PARTS LIST

Item	Description	Drawing	Pcs
E	Table Top		1
F	Base		1

STEP: 1

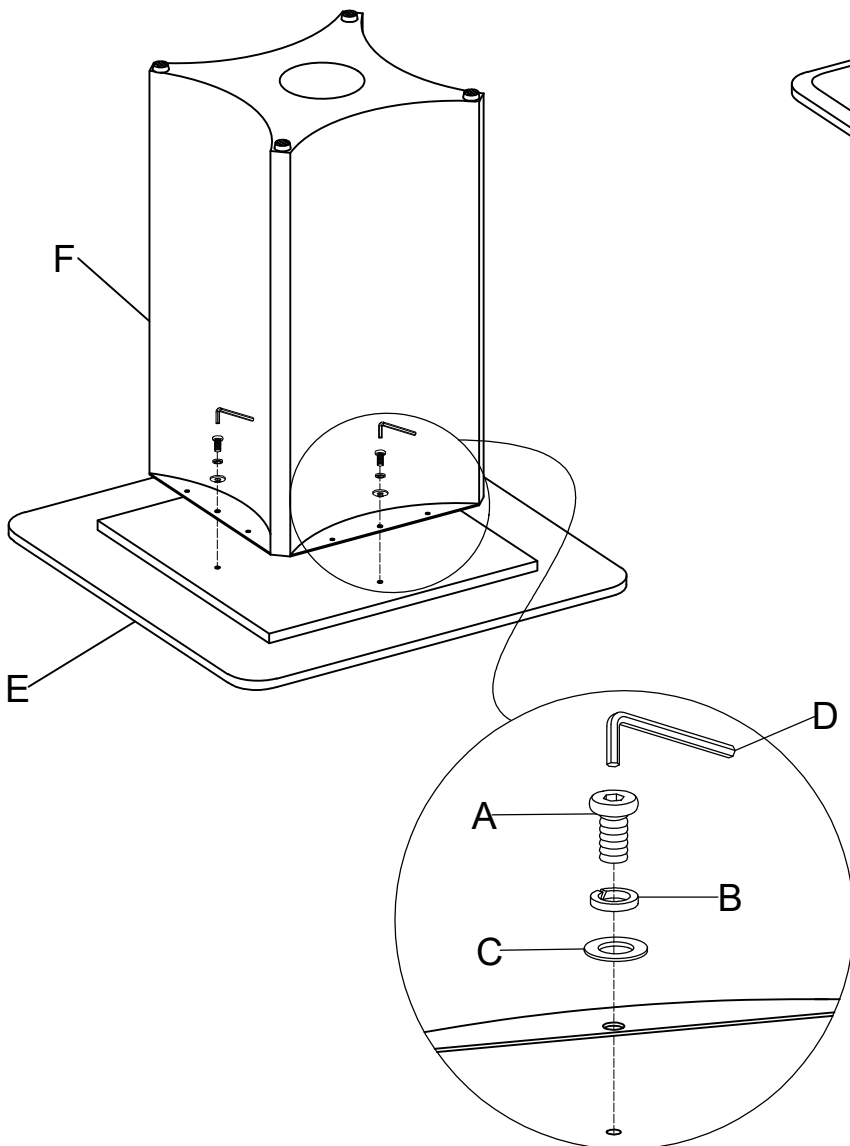

STEP: 2

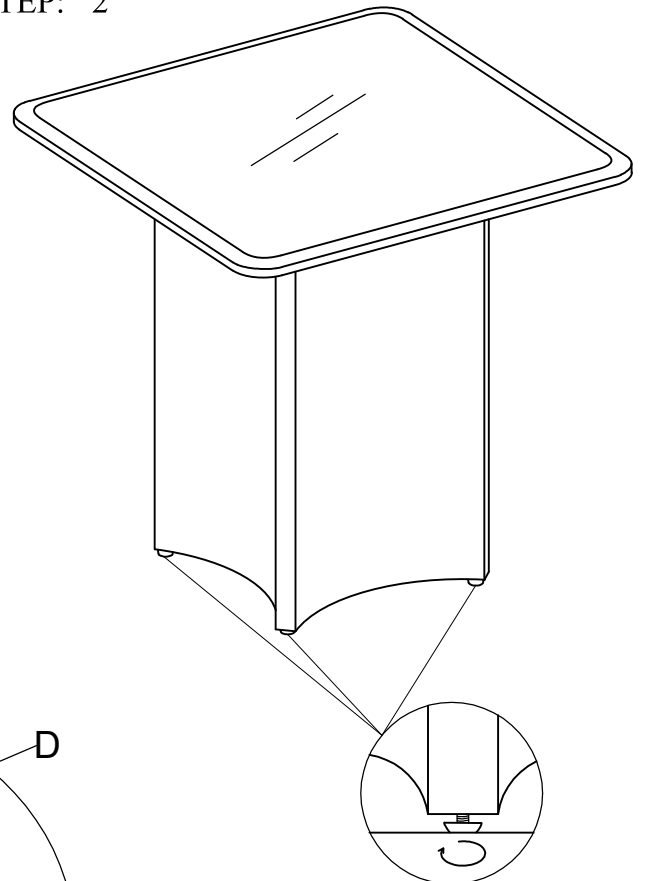

Adjust Pre-installed Levelers height to achieve balance.

Do not tighten screws until completely assembled