

# ASSEMBLY INSTRUCTIONS



## TOOLS REQUIRED:

- Allen Wrench (Provided, Part G)
- Allen Key (Provided, Part H)
- Phillips Screw Driver (Not Provided)

## BEFORE YOU START:

1. Check the hardware against the hardware list to make sure all items are present.
2. Assemble your furniture on a soft, flat surface to avoid scratching the finish.
3. CAUTION: Do not over tighten screws, nuts or bolts during assembly.
4. Your furniture may require occasional tightening.

## INSTRUCTIONS:

1. Turn the table on to a clean soft surface .
2. Attach the legs to the Table Top using Hex nuts (B), Lock Washer(E), Flat washer (F) and using Wrench(G) (Do not tighten completely yet). As shown in Figure 1 .
3. Attach bottom shelf to the legs using Bolt (A), Lock Washer(C), Flat Washer (D) and using Allen Key(H) (Do not tighten completely yet). As shown in Figure 2 .
4. Tighten all bolts using Wrench(G) and Allen Key(H) After completing step 3.
5. Set table back up right and open the Drawer. Take the handle out and reassemble it. As shown in Figure 3 .

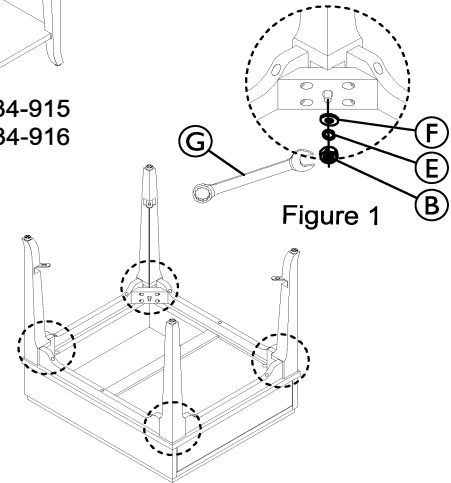

Figure 1

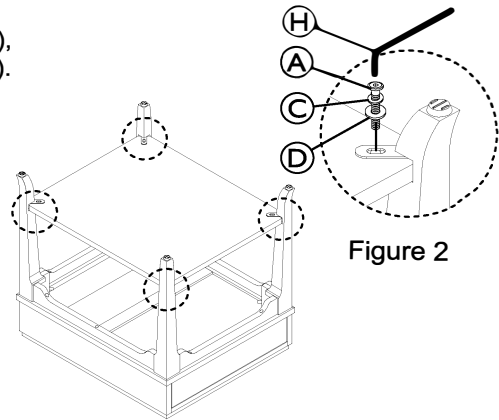

Figure 2

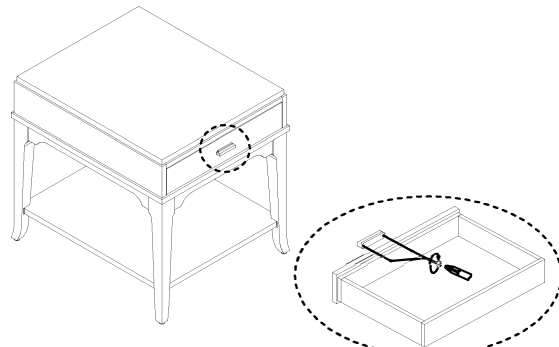









Figure 3

HARDWARE LIST			
A		Ø1/4"x3/4" Bolt	4pcs
B		Ø5/16" Hex Nuts	4pcs
C		Ø1/4"x10mm Lock Washer	4pcs
D		Ø1/4" x16mm Flat Washer	4pcs
E		Ø5/16"x13mm Lock Washer	4pcs
F		Ø5/16" x19mm Flat Washer	4pcs
G		13mm Wrench	1pc
H		1/4"x100mm Allen Key	1pc

