

ASSEMBLY INSTRUCTIONS



A 1pc



B 1pc



C 1pc

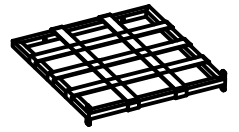

D 1pc



M6*15

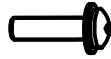

M6*40



G 1pc

E 4pcs

F 4pcs

1

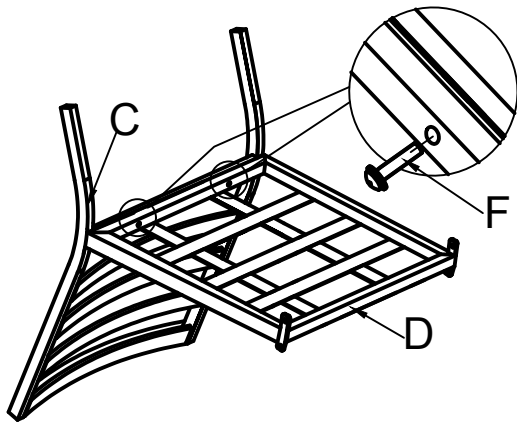

2

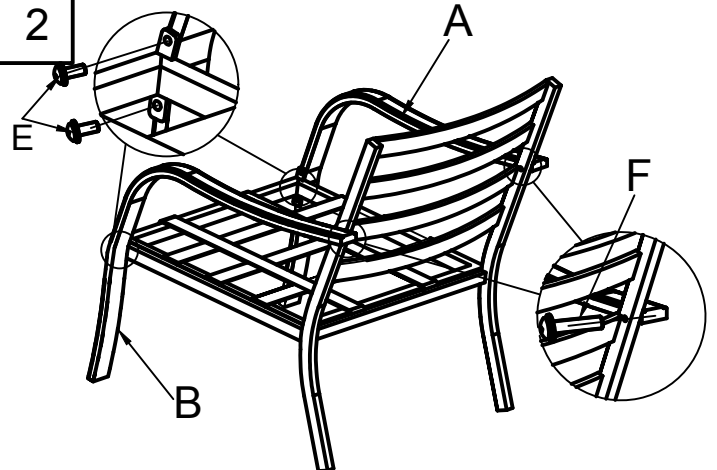







3

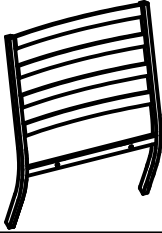
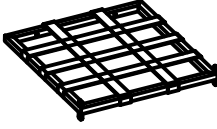

ASSEMBLY TIPS:

Please use the hardware and accessories included in the set. DO NOT use other electrical or manual tools. In order to facilitate the assembly and make your final product firm and stable, please tighten by a few rounds each screw one by one. After all screws are connected, then you start to tighten each screw to the end. DO NOT tighten any screw to the end before you have connected all screws. The assembly requires minimal level of DIY skills if you follow the instructions carefully.

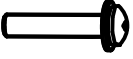
Packing List

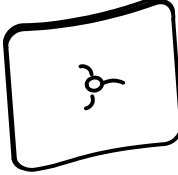
				 M6*15	 M6*40
A 1pcs	B 1pcs	C 1pc	D 1pc	E 4+1pcs	F 4+1pcs
					
G 1pc	H 1pc	I 1pc			

WARNING:

Cushions must be put away in rainy and windy days in case they are diminished or blown away.

ASSEMBLY TIPS: Please use the hardware and accessories included in the set. DO NOT use other electrical or manual tools. In order to facilitate the assembly and make your final product firm and stable, please tighten by a few rounds each screw one by one. After all screws are connected, then you start to tighten each screw to the end.

DO NOT tighten any screw to the end before you have connected all screws.

The assembly requires minimal level of DIY skills if you follow the instructions carefully.

ASSEMBLY INSTRUCTIONS

PF21182



A 1pc



B 1pc



C 1pc

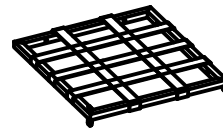

D 1pc

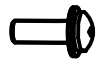

M6*15

E 5pcs

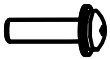

M6*40

F 5pcs



G 1pc

1

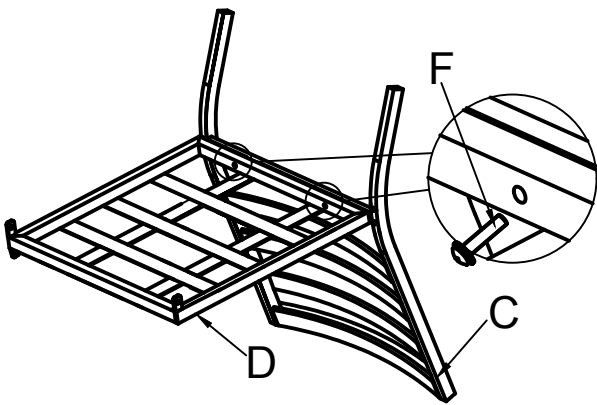

2

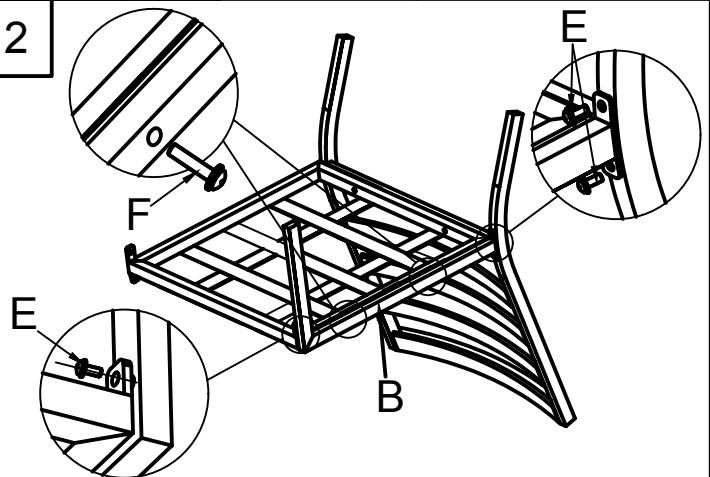

3

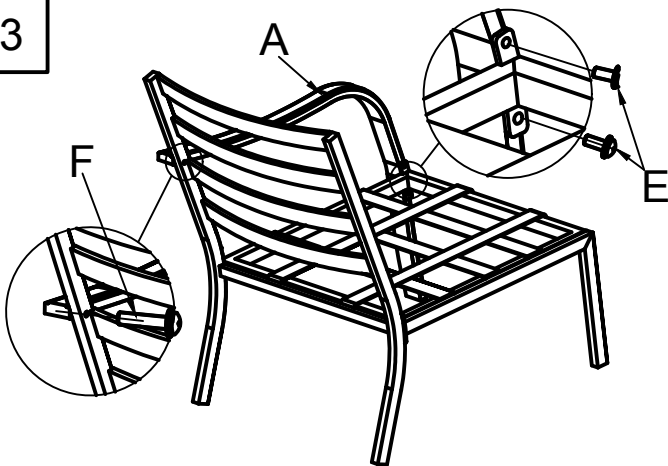

4









ASSEMBLY TIPS:

Please use the hardware and accessories included in the set. DO NOT use other electrical or manual tools. In order to facilitate the assembly and make your final product firm and stable, please tighten by a few rounds each screw one by one. After all screws are connected, then you start to tighten each screw to the end. DO NOT tighten any screw to the end before you have connected all screws. The assembly requires minimal level of DIY skills if you follow the instructions carefully.

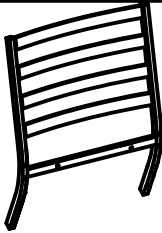
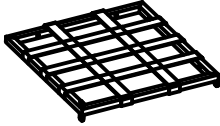
Packing List

PF21182

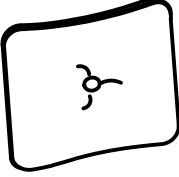
				 M6*15
A 1pc	B 1pc	C 1pc	D 1pc	E 5+2pcs
 M6*40				
F 5+2pcs	G 1pc	H 1pc	I 1pc	

WARNING:

Cushions must be put away in rainy and windy days in case they are diminished or blown away.







ASSEMBLY TIPS: Please use the hardware and accessories included in the set. DO NOT use other electrical or manual tools. In order to facilitate the assembly and make your final product firm and stable, please tighten by a few rounds each screw one by one. After all screws are connected, then you start to tighten each screw to the end.

DO NOT tighten any screw to the end before you have connected all screws.

The assembly requires minimal level of DIY skills if you follow the instructions carefully.

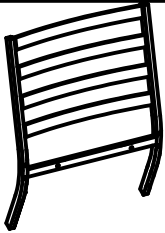
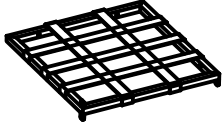
ASSEMBLY INSTRUCTIONS

PF21183

				 M6*15
A 1pc	B 1pc	C 1pc	D 1pc	E 5pcs
 M6*40				
F 5pcs	G 1pc			

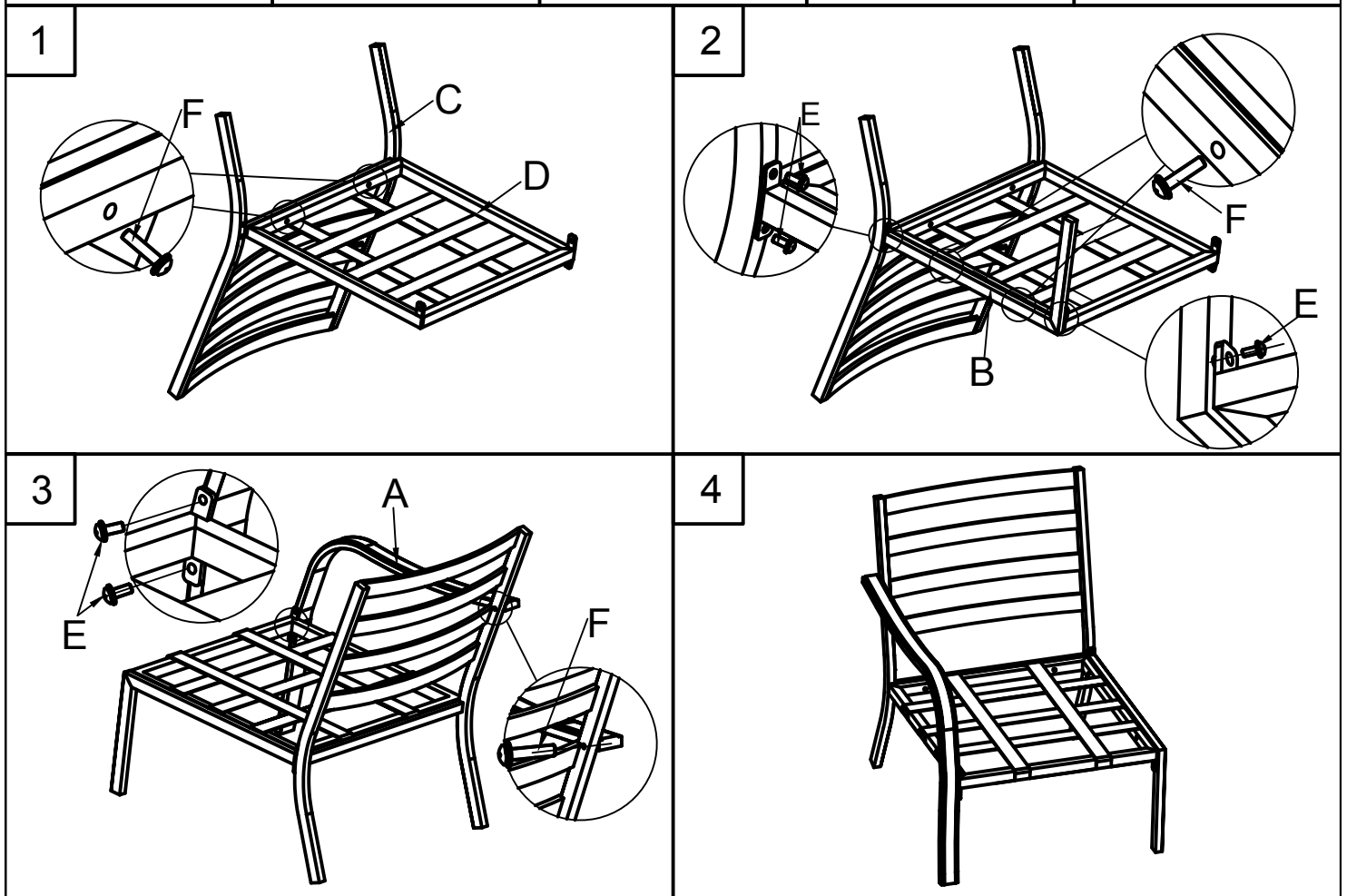







ASSEMBLY TIPS:

Please use the hardware and accessories included in the set. DO NOT use other electrical or manual tools. In order to facilitate the assembly and make your final product firm and stable, please tighten by a few rounds each screw one by one. After all screws are connected, then you start to tighten each screw to the end. DO NOT tighten any screw to the end before you have connected all screws. The assembly requires minimal level of DIY skills if you follow the instructions carefully.

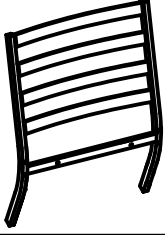
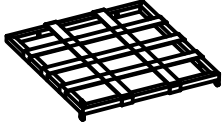
Packing List

PF21183

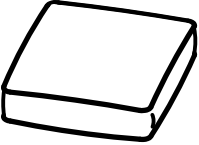
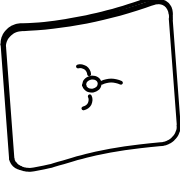
				 M6*15
A 1pc	B 1pc	C 1pc	D 1pc	E 5+2pcs
 M6*40				
F 5+2pcs	G 1pc	H 1pc	I 1pc	

WARNING:







Cushions must be put away in rainy and windy days in case they are diminished or blown away.

ASSEMBLY TIPS: Please use the hardware and accessories included in the set. DO NOT use other electrical or manual tools. In order to facilitate the assembly and make your final product firm and stable, please tighten by a few rounds each screw one by one. After all screws are connected, then you start to tighten each screw to the end.

DO NOT tighten any screw to the end before you have connected all screws.

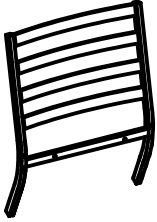
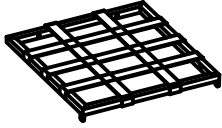
The assembly requires minimal level of DIY skills if you follow the instructions carefully.

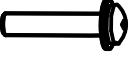
ASSEMBLY INSTRUCTIONS



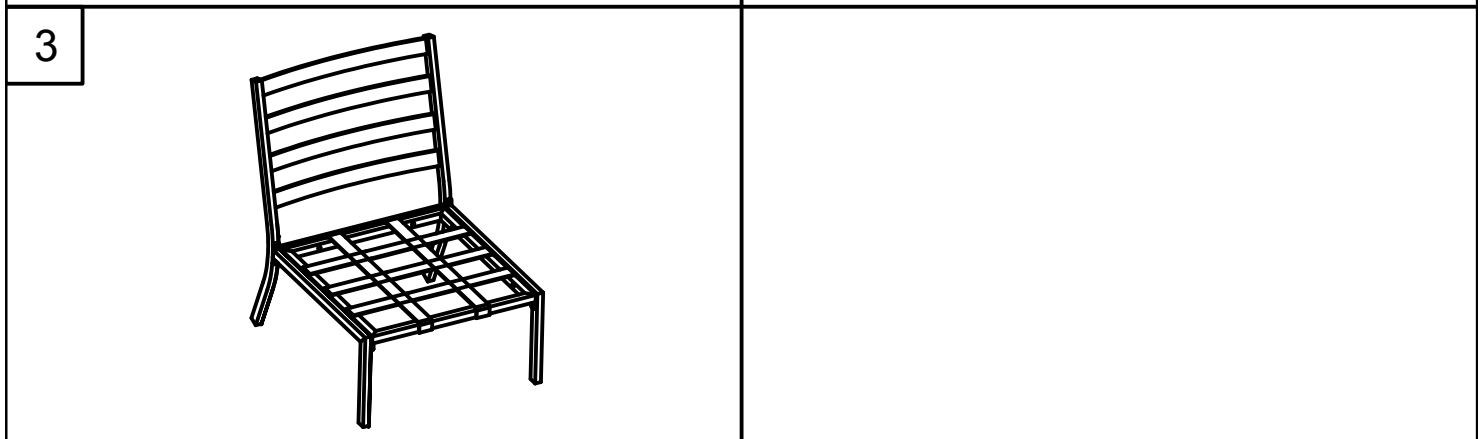
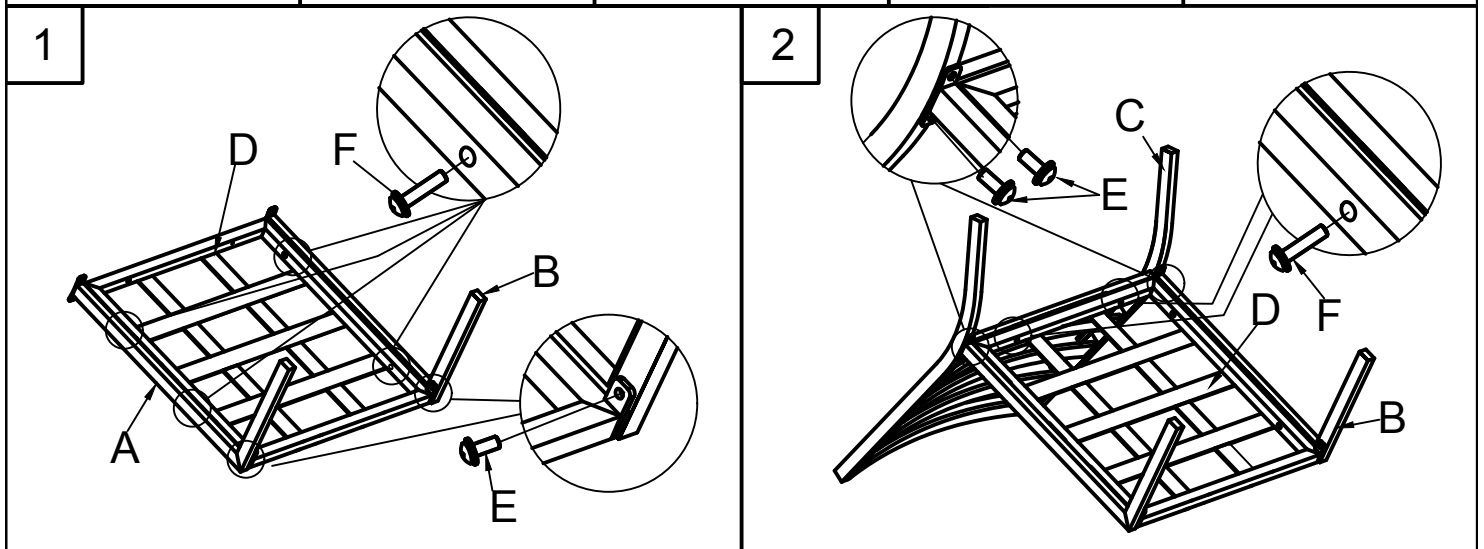



				 M6*15
A 1pc	B 1pc	C 1pc	D 1pc	E 6pcs
 M6*40				
F 6pcs	G 1pc			

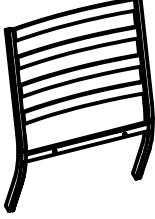
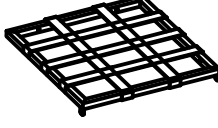

ASSEMBLY TIPS:

Please use the hardware and accessories included in the set. DO NOT use other electrical or manual tools. In order to facilitate the assembly and make your final product firm and stable, please tighten by a few rounds each screw one by one. After all screws are connected, then you start to tighten each screw to the end. DO NOT tighten any screw to the end before you have connected all screws. The assembly requires minimal level of DIY skills if you follow the instructions carefully.

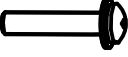
Packing List

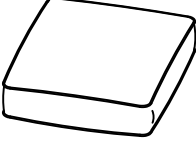
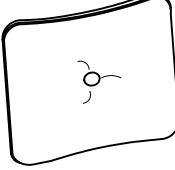
				 M6*15
A 1pc	B 1pc	C 1pc	D 1pc	E 6+2pcs
 M6*40				
F 6+2pcs	G 1pc	H 1pc	I 1pc	

WARNING:







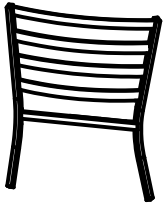
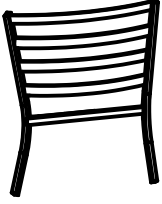

Cushions must be put away in rainy and windy days in case they are diminished or blown away.

ASSEMBLY TIPS: Please use the hardware and accessories included in the set. **DO NOT** use other electrical or manual tools. In order to facilitate the assembly and make your final product firm and stable, please tighten by a few rounds each screw one by one. After all screws are connected, then you start to tighten each screw to the end.

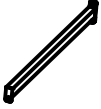
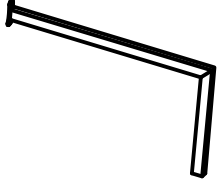
DO NOT tighten any screw to the end before you have connected all screws.

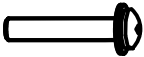
The assembly requires minimal level of DIY skills if you follow the instructions carefully.



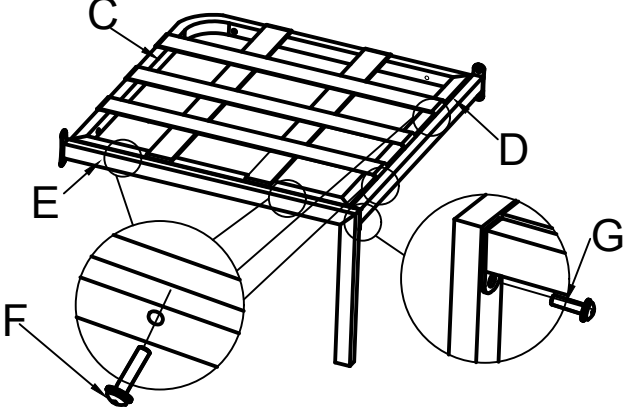
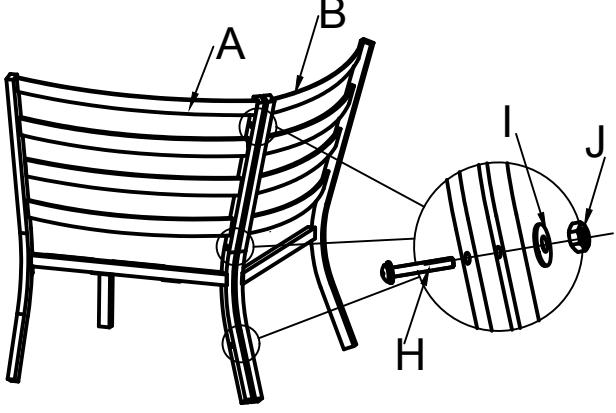
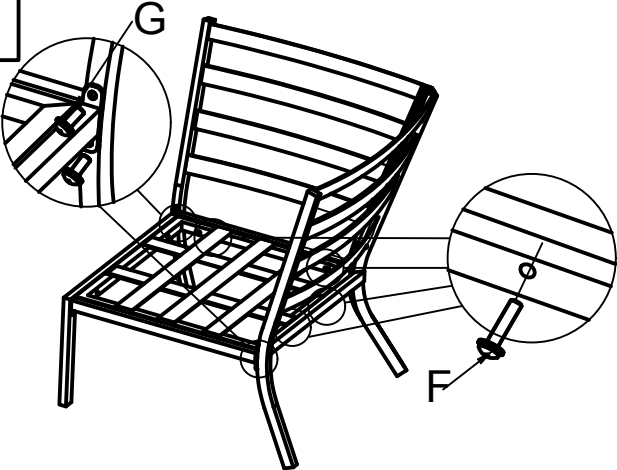
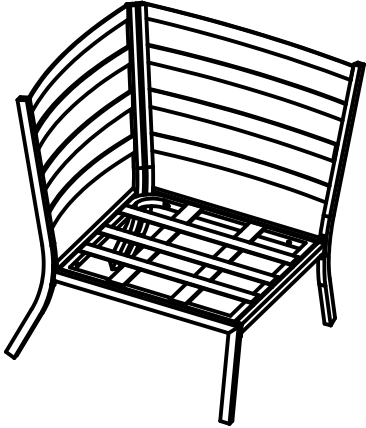





ASSEMBLY INSTRUCTIONS

					 M6*40
A 1pc	B 1pc	C 1pc	D 1pc	E 1pc	F 8pcs
 M6*15	 M6*50	 ø13*ø6.5*1.0	 M6		 M6
G 5pcs	H 3pcs	I 3pcs	J 3pcs	K 1pc	L 1pc
1					
2					
3					
4					

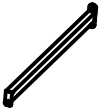
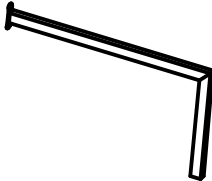
ASSEMBLY TIPS:

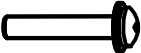
Please use the hardware and accessories included in the set. DO NOT use other electrical or manual tools. In order to facilitate the assembly and make your final product firm and stable, please tighten by a few rounds each screw one by one. After all screws are connected, then you start to tighten each screw to the end. DO NOT tighten any screw to the end before you have connected all screws. The assembly requires minimal level of DIY skills if you follow the instructions carefully.

Packing List

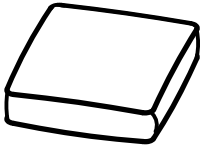
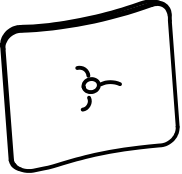
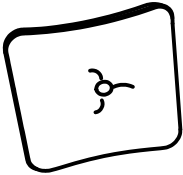
					 M6*40
A 1pc	B 1pc	C 1pc	D 1pc	E 1pc	F 8+2pcs
 M6*15	 M6*50	 ø13*ø6.5*1.0	 M6		 M6
G 5+2pcs	H 3+1pcs	I 3+1pcs	J 3+1pcs	K 1pc	L 1pc
					
M 1pc	N 1pc	O 1pc			

WARNING:

Cushions must be put away in rainy and windy days in case they are diminished or blown away.

ASSEMBLY TIPS: Please use the hardware and accessories included in the set. DO NOT use other electrical or manual tools. In order to facilitate the assembly and make your final product firm and stable, please tighten by a few rounds each screw one by one. After all screws are connected, then you start to tighten each screw to the end.

DO NOT tighten any screw to the end before you have connected all screws.

The assembly requires minimal level of DIY skills if you follow the instructions carefully.

ASSEMBLY INSTRUCTIONS

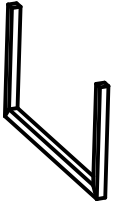

A 2pcs

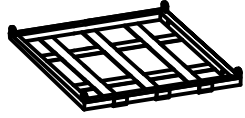

B 1pc



M6*15

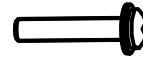

M6*40



E 1pc

1

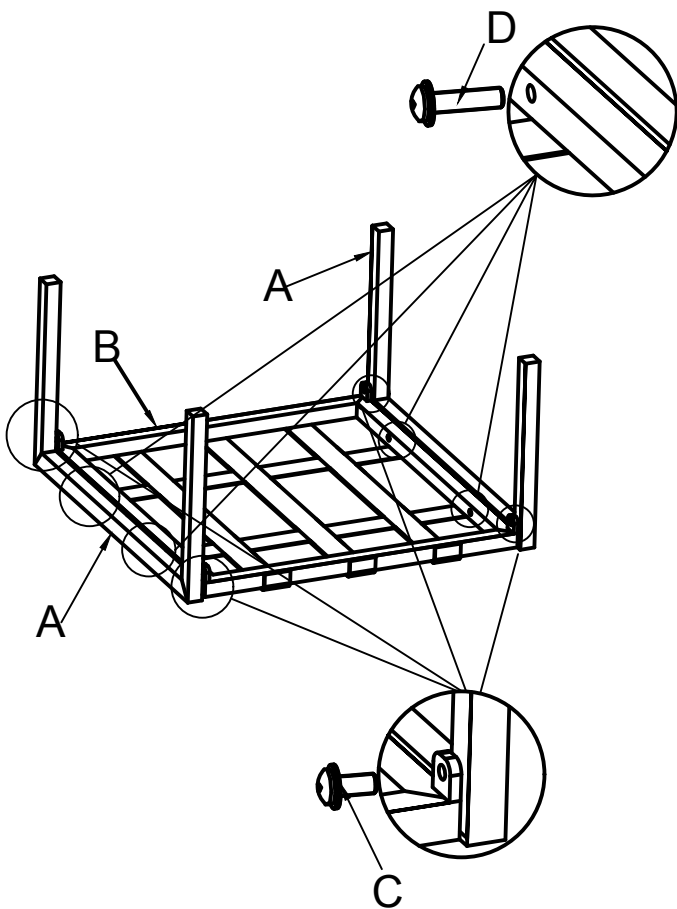



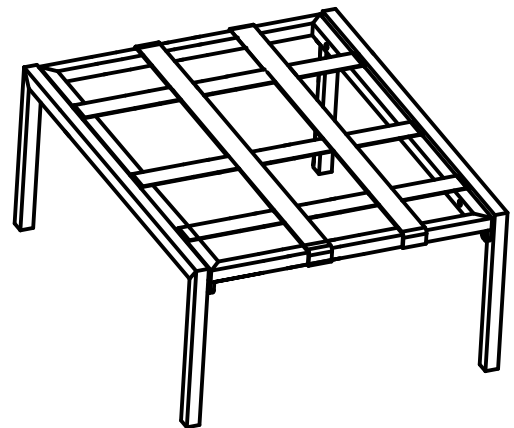

2

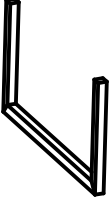
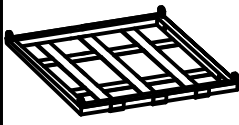

ASSEMBLY TIPS:

Please use the hardware and accessories included in the set. DO NOT use other electrical or manual tools. In order to facilitate the assembly and make your final product firm and stable, please tighten by a few rounds each screw one by one. After all screws are connected, then you start to tighten each screw to the end. DO NOT tighten any screw to the end before you have connected all screws. The assembly requires minimal level of DIY skills if you follow the instructions carefully.

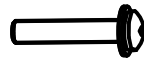
Packing List

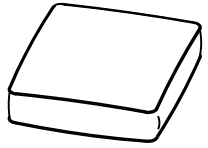
		 M6*15	 M6*40		
A 2pcs	B 1pc	C 4+1pcs	D 4+1pcs	E 1pc	F 1pc

WARNING:

Cushions must be put away in rainy and windy days in case they are diminished or blown away.

ASSEMBLY TIPS: Please use the hardware and accessories included in the set. DO NOT use other electrical or manual tools. In order to facilitate the assembly and make your final product firm and stable, please tighten by a few rounds each screw one by one. After all screws are connected, then you start to tighten each screw to the end.

DO NOT tighten any screw to the end before you have connected all screws.

The assembly requires minimal level of DIY skills if you follow the instructions carefully.

ASSEMBLY INSTRUCTIONS

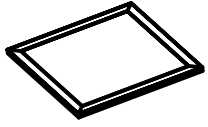

A 1pc

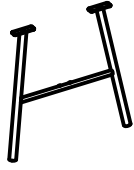

B 2pcs



C 1pc

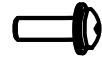

M6*15



E 1pc

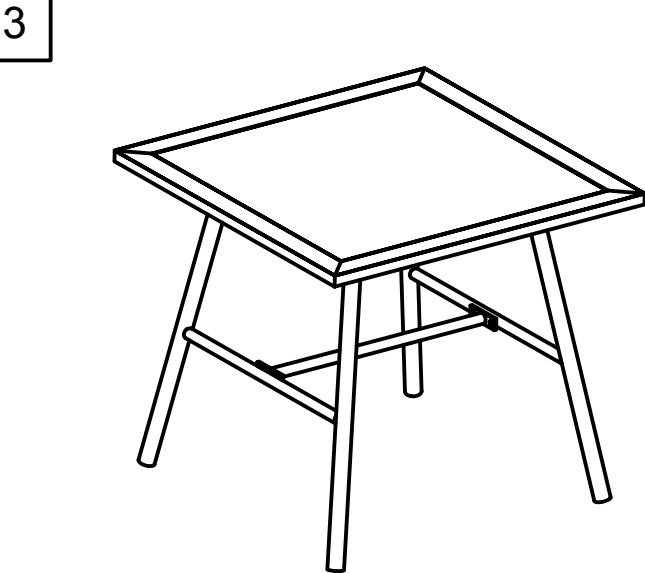
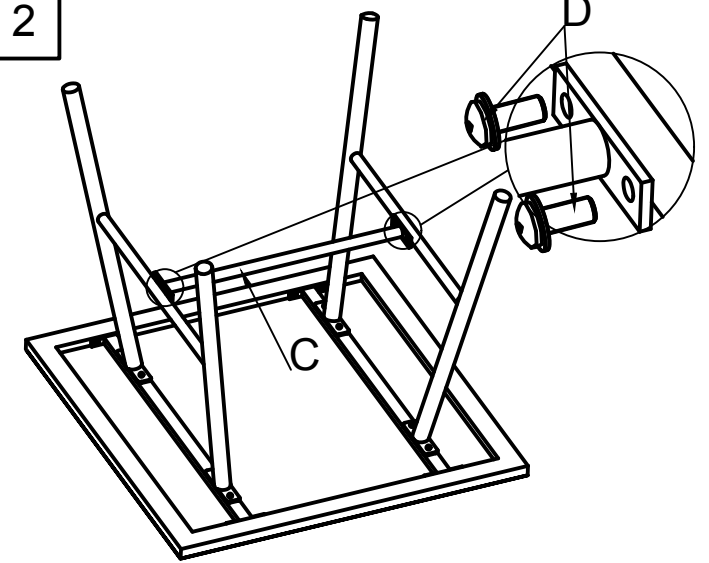
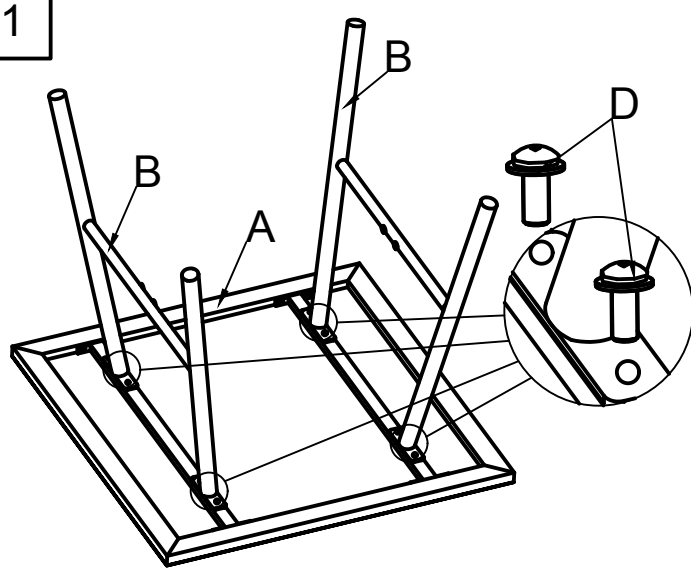





4

ASSEMBLY TIPS:

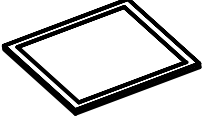
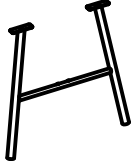
Please use the hardware and accessories included in the set. DO NOT use other electrical or manual tools. In order to facilitate the assembly and make your final product firm and stable, please tighten by a few rounds each screw one by one. After all screws are connected, then you start to tighten each screw to the end. DO NOT tighten any screw to the end before you have connected all screws. The assembly requires minimal level of DIY skills if you follow the instructions carefully.

Packing List

			 M6*15		
A 1pc	B 2pcs	C 1pc	D 12+3pcs	E 1pc	

WARNING:

Cushions must be put away in rainy and windy days in case they are diminished or blown away.

ASSEMBLY TIPS: Please use the hardware and accessories included in the set. DO NOT use other electrical or manual tools. In order to facilitate the assembly and make your final product firm and stable, please tighten by a few rounds each screw one by one. After all screws are connected, then you start to tighten each screw to the end.

DO NOT tighten any screw to the end before you have connected all screws.

The assembly requires minimal level of DIY skills if you follow the instructions carefully.

ASSEMBLY INSTRUCTIONS

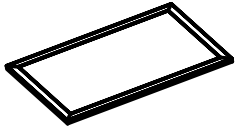

A 1pc

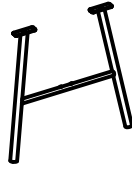

B 2pcs



C 1pc

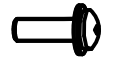

M6*15



E 1pc

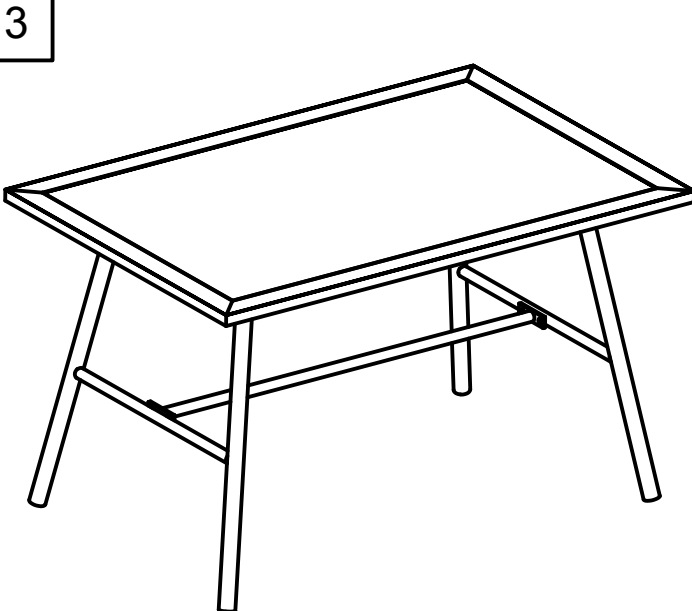
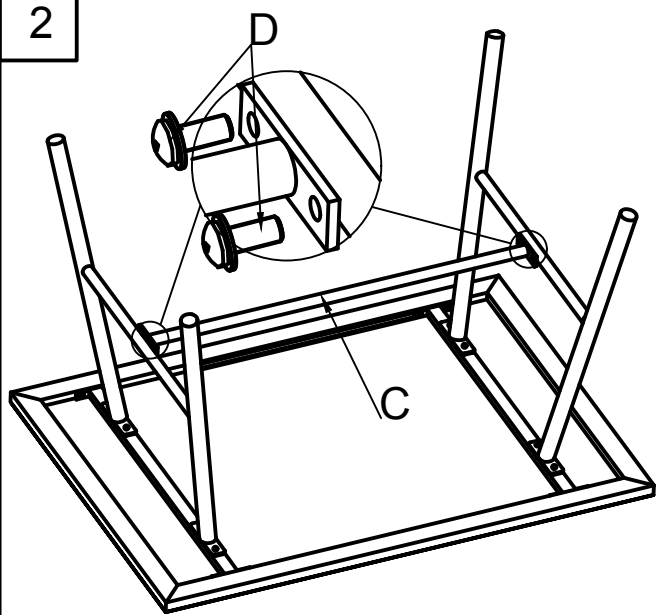
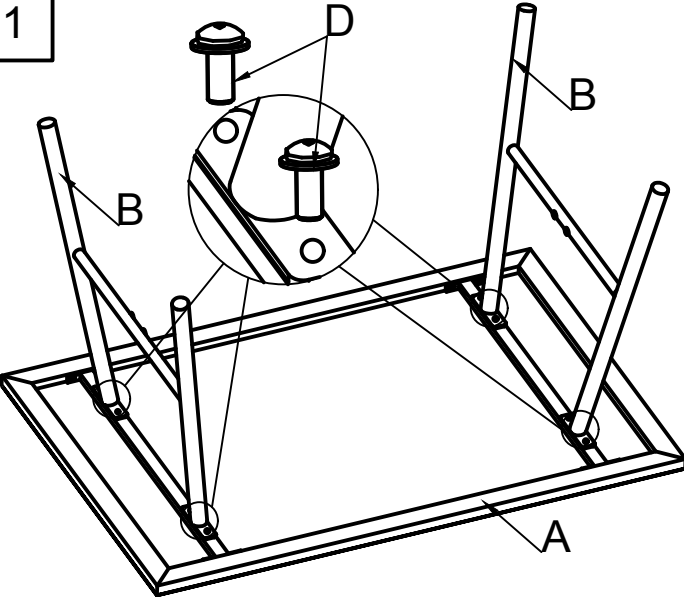





4

ASSEMBLY TIPS:

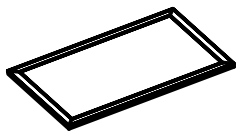
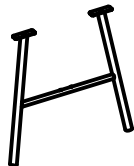
Please use the hardware and accessories included in the set. DO NOT use other electrical or manual tools. In order to facilitate the assembly and make your final product firm and stable, please tighten by a few rounds each screw one by one. After all screws are connected, then you start to tighten each screw to the end. DO NOT tighten any screw to the end before you have connected all screws. The assembly requires minimal level of DIY skills if you follow the instructions carefully.

Packing List

			 M6*15		
A 1pc	B 2pcs	C 1pc	D 12+3pcs	E 1pc	

WARNING:

Cushions must be put away in rainy and windy days in case they are diminished or blown away.

ASSEMBLY TIPS: Please use the hardware and accessories included in the set. DO NOT use other electrical or manual tools. In order to facilitate the assembly and make your final product firm and stable, please tighten by a few rounds each screw one by one. After all screws are connected, then you start to tighten each screw to the end.

DO NOT tighten any screw to the end before you have connected all screws.

The assembly requires minimal level of DIY skills if you follow the instructions carefully.