

Assembly Instructions

Caution : You must read this before you proceed

Please look in the left leg for hardware packs.

DINING CHAIR

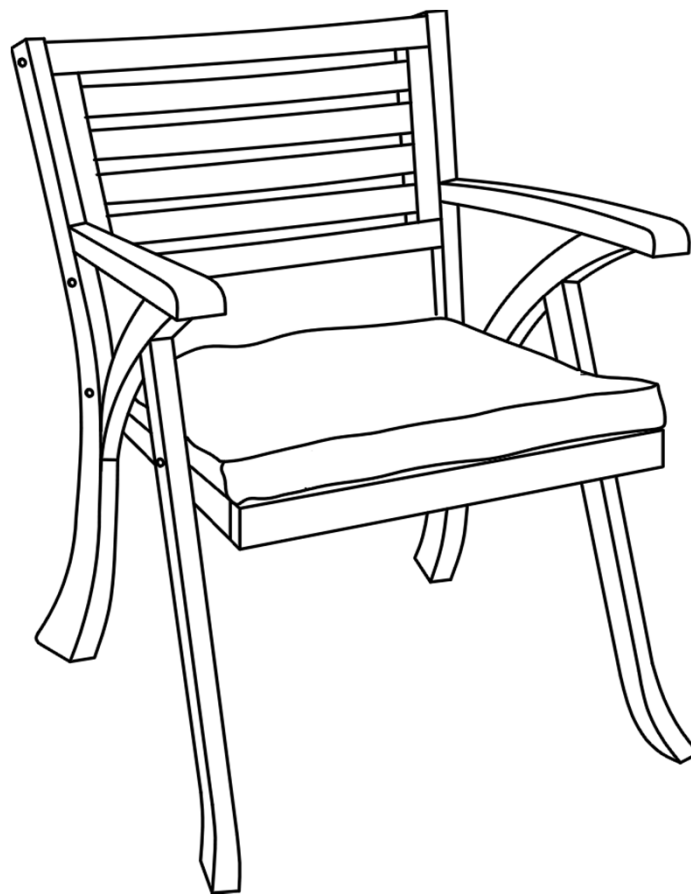





CAUTION: This Chair is NOT a TOY.

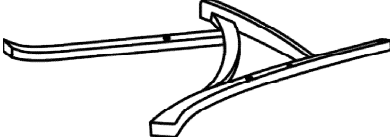

Keep your child / children at bay during the assembly process.

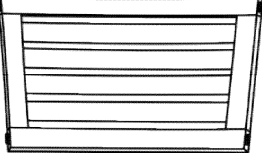
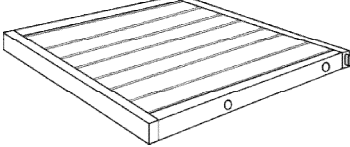
For moving the Chair and to prevent damage to the Chair, two adults are needed to execute this action.

Parts List

Label	Picture	Description	QTY
A		Left Leg	1
B		Right Leg	1
C		Backrest	1
D		Seat Panel	1
E		Seat Cushion	1

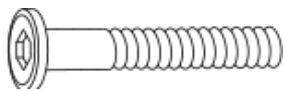



Hardware

Label	Picture	Description	QTY
①		Screw (M6x45mm)	7
②		Bolt (M6x40mm)	3
③		Sleeve Nut (M6x13mm)	3
④		Allen Key	2

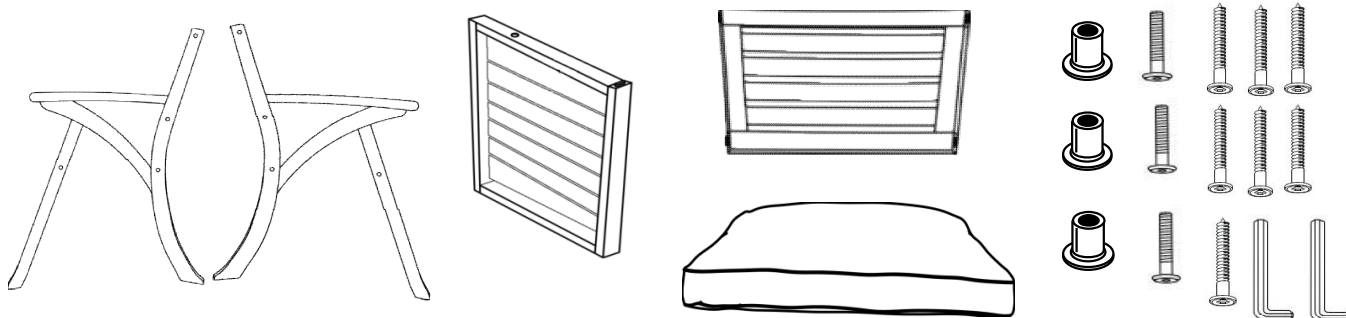
Assembly Preparation

Before Beginning Assembly:



-  • Read instructions, cover to cover-
-  • Have 2 adults on hand for assembly-
-  • Do not assemble on flooring or carpet-
-  • Assemble on a clean non-marring surface (packing foam)-
-  • Save all packaging until finished-

Assembly Steps

OVERVIEW

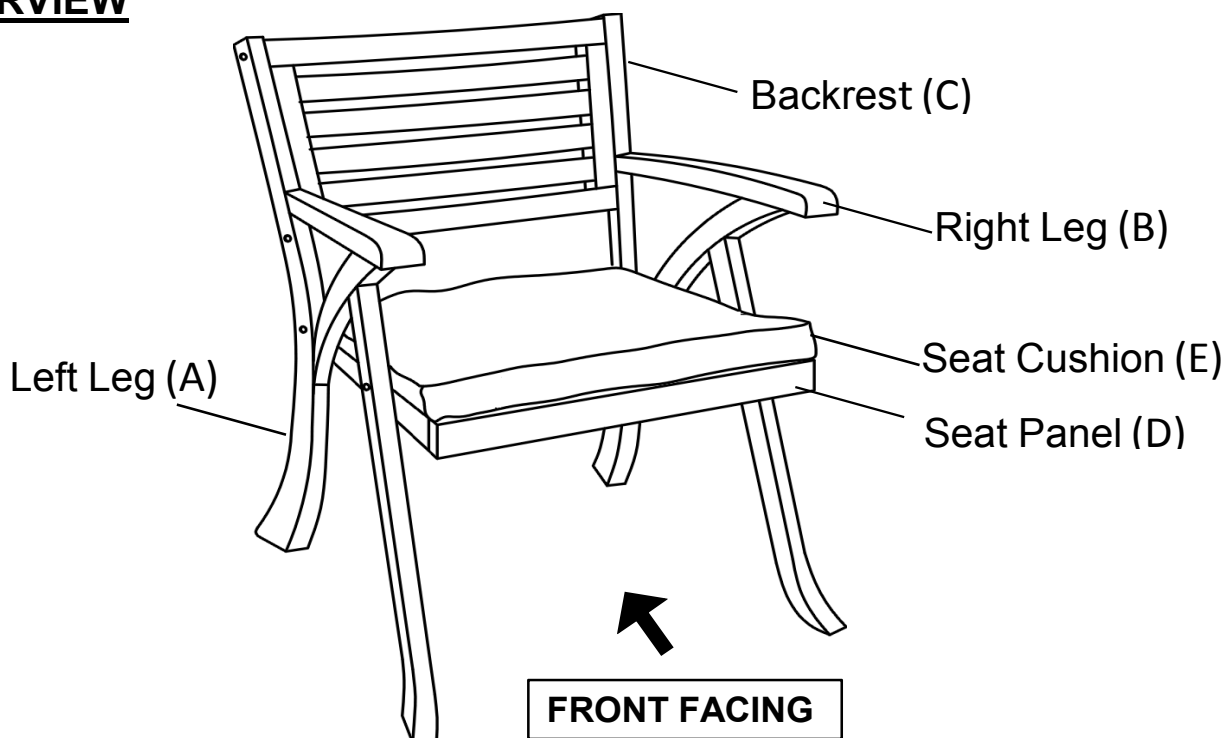

This Chair has multiple parts and may require up to some 30 minutes to assemble. To give you an overview of the Chair parts, the above picture is to help you put the various parts into perspective. Please read through the instructions below to familiarise yourself with the parts and steps before assembly.

Step 1

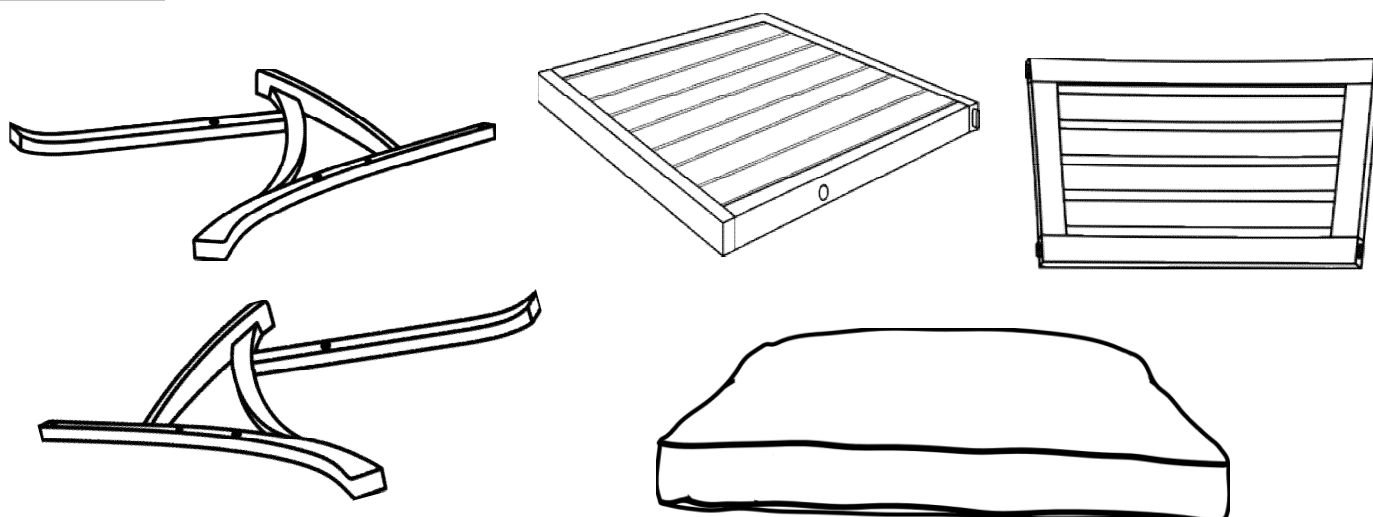

Unpack and place all parts on a clean, non-marring surface.

Step 2

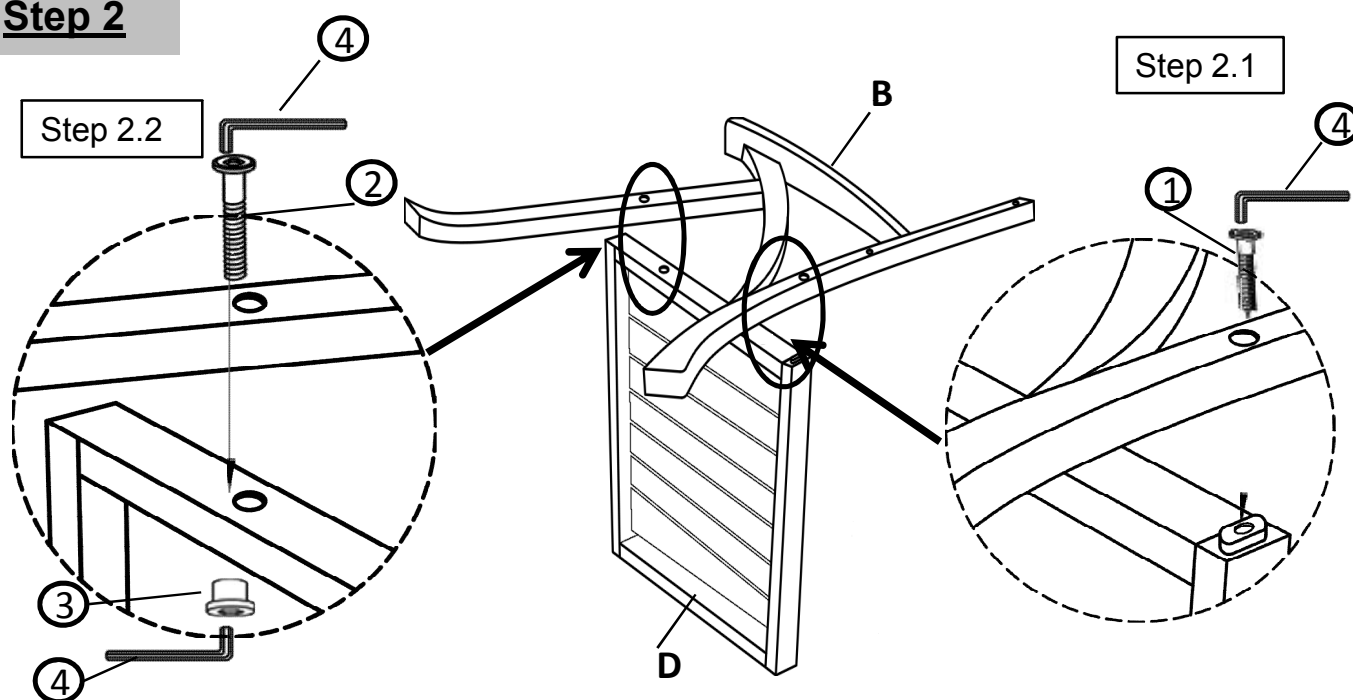

2.1) Position Right Leg(B) and Seat Panel(D) as shown in picture above. Secure Right Leg(B) and Seat Panel(D) using Screw(①) with Allen Key(④).

2.2) Secure Right Leg(B) and Seat Panel(D) using Bolt(②), and Sleeve Nut(③) with Allen Key(④).

Only loosely tighten the Screws and Bolts.

Step 3

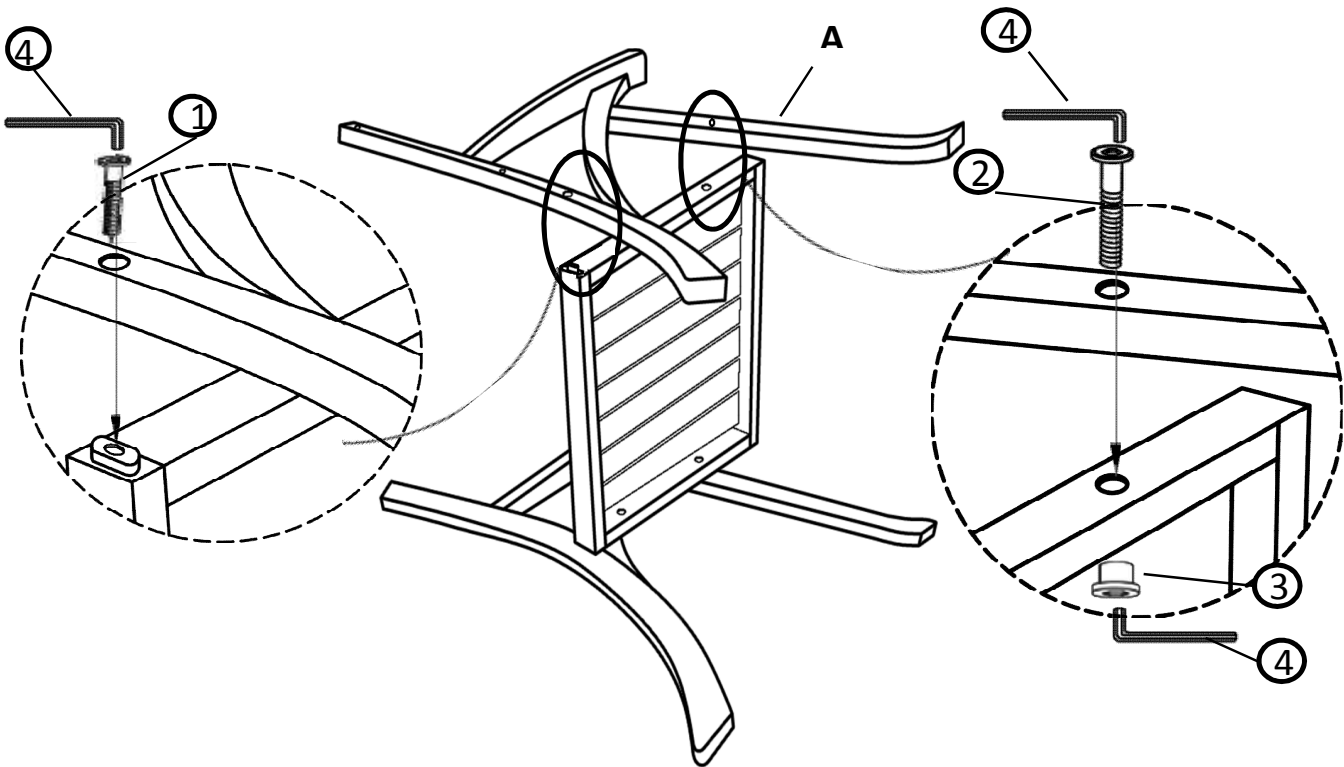

With the help of your partner, turn the Chair over and rest on Right Leg(B). Repeat the same process from the previous step to attach the Left Leg(A). **Only loosely tighten the Screws and Bolts.**

Step 4

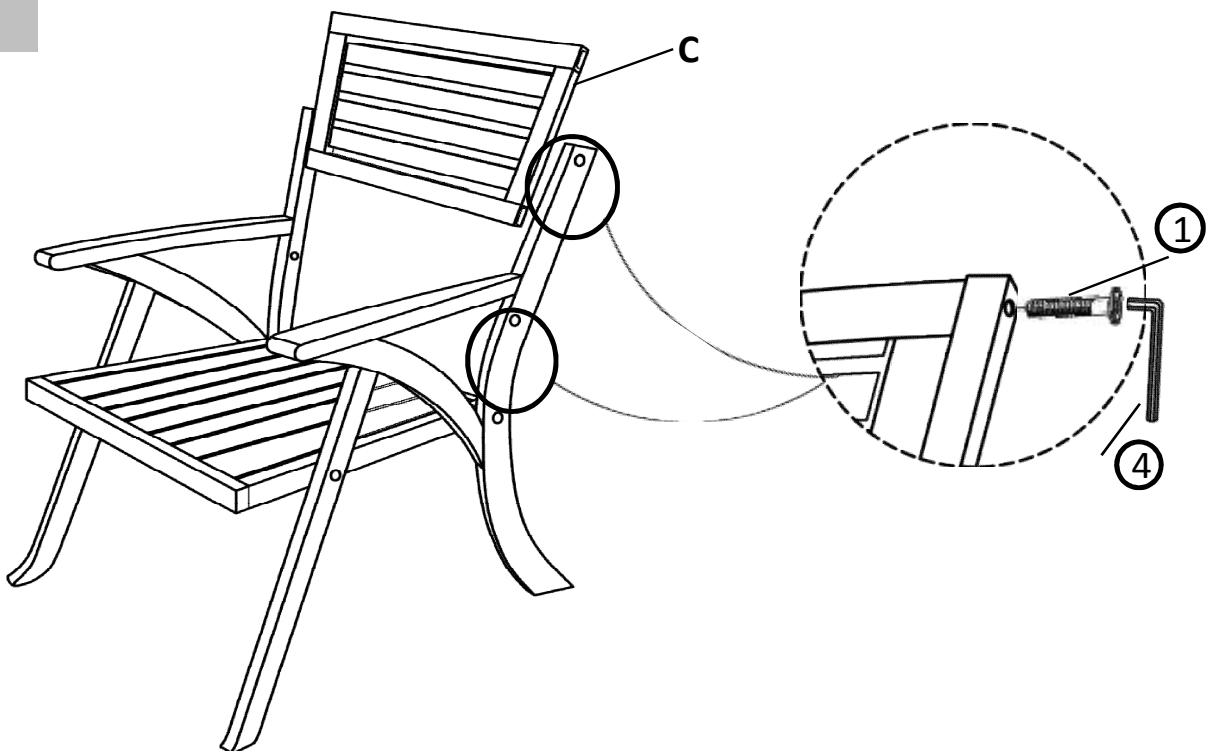

Place Backrest(C) into the housing of Left Leg(A) and Right Leg(B). You may need to apply a little pressure to the Legs, pushing outwards, to enable the Backrest(C) to be slotted into position. Secure Backrest(C) and Legs using Screws(1) with Allen Key(4). Only loosely tighten the Screws.

Step 5

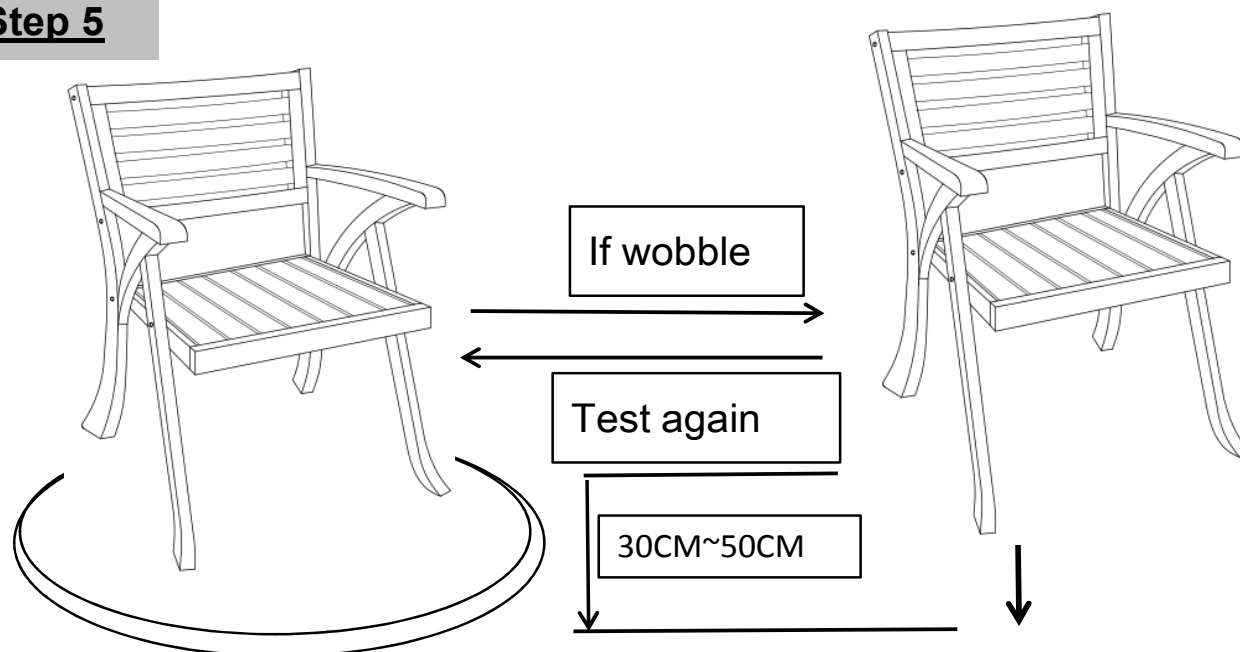

Place the Chair right side up on a LEVEL SURFACE to see if it wobbles. If it wobbles, lift the Chair to some 30cm to 50cm height from the ground. Keep your feet and toes well away from the drop zone. Drop the Chair freely and vertically with the four legs, hitting the ground, at the same time. This Drop Test will help to ensure that all the Bolts, Screws and gaps all reach full alignment status.

Test again for evenness on a LEVEL SURFACE.

If no wobbles are found, proceed to tighten all the Screws, and Bolts.

CAUTION: When tightening the Screws, and Bolts tighten sequentially. DO NOT tighten any Bolt, or Screw fully and then move towards the next one. This could cause the frame to warp.

If there are still wobbles, loosen the Screws and Bolts and execute this same drop tests. **If the Chair is not stable, it could lead to damage to the product.**

Step 6

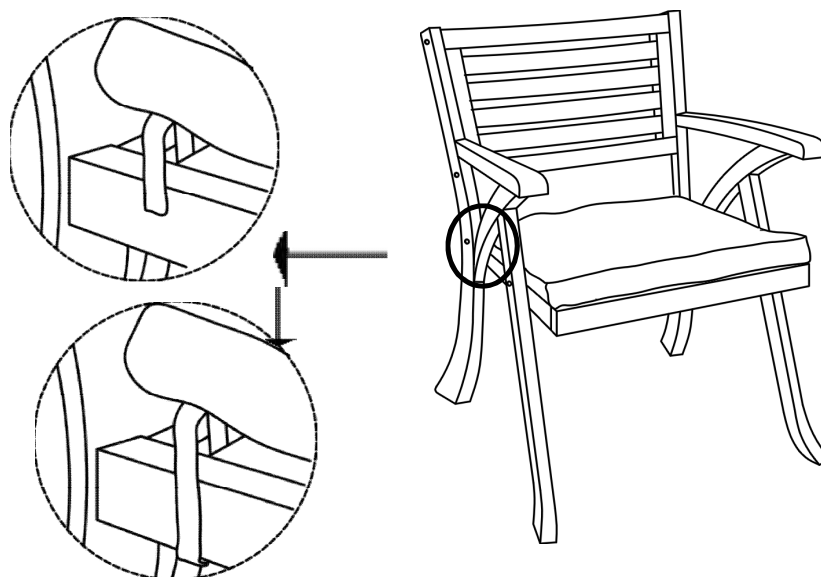









Inspect the Chair and make sure all parts are adequately connected. Place Seat Cushion(C) on to the seat of the Chair using the velcro straps as shown above.

Your Chair is ready for use.

This Chair can only be used on a flat, level surface.

Care & Maintenance

- ⊘  ● Do not put hot items directly on furniture surface
 - ⊘  ● Do not clean furniture with harsh cleansers or polish.
 - ✓  ● To obtain the longest lifespan of your outdoor products, minimizing exposure to direct sunlight is recommended.
 - ⊘  ● Children should not climb or jump on the furniture.
 - ⊘  ● Do not write on furniture without a padded barrier to protect the surface.
 - ✓  ● To obtain the longest lifespan of your outdoor products, avoid extended and lengthy exposure to rain, snow, and direct sunshine. Whenever possible cover the product and /or place under patio or awnings.
 - ⊘  ● Not for commercial use. For residential use only .
 - ⊘  ● Stains may be removed with mild soap solution and damp cloth.
-
- ✓  ● Dust and pick-up spills using a clean, non-colored, lint-free cloth .