

Installation Instructions

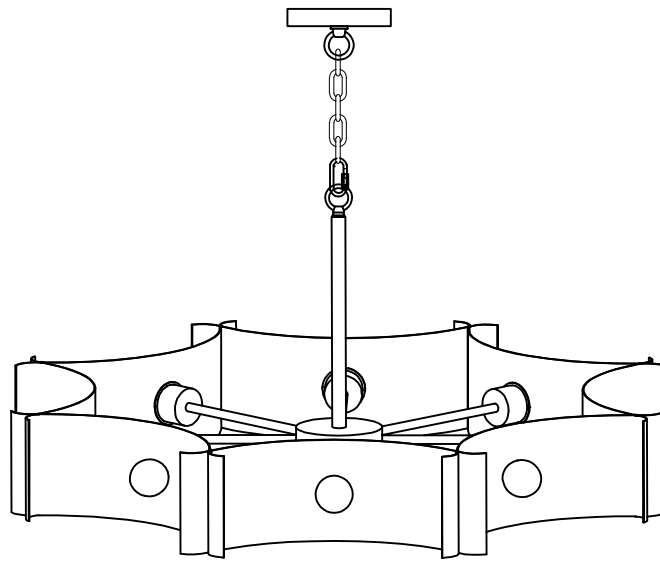

8x Max 60W Candelabra Base

Safety Information

READ AND SAVE THESE INSTRUCTIONS

1. For your protection and safety, carefully read and understand the information provided in this manual completely before attempting to assemble, install, or operate this product. Failure to do so could lead to electrical shock, fire, or other injuries that could be hazardous or even fatal.
2. Before touching any wire, use a voltage tester to make sure it not live.
3. When replacing fuses, turn off the main power first. Make sure your hands and feet are dry, and place one hand behind your back to prevent electricity from making a complete circuit through your chest. Touch the plug fuse only by its insulated rim. Remove cartridge fuses with a fuse puller
4. Use tools with insulated handles and ladders made of wood or fiberglass.
5. To protect children, place a safety cover over any unused outlets.



DANGER: Before starting installation of this fixture or removal of a previous fixture, disconnect the power by turning off the circuit breaker, removing the fuse at the fuse box, or tripping the breaker that controls that circuit. Tape a sign to the panel warning others to leave the circuit alone while you work.



CAUTION: CONSULT A QUALIFIED ELECTRICIAN IF YOU HAVE ANY ELECTRICAL QUESTIONS. If you have any non-electrical questions about this fixture please contact our customer service via the distributor where you purchased this product from. We will be more than happy to assist.

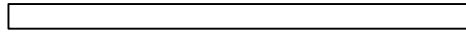

Suspension tube 1PCS



3PCS



3PCS



3PCS

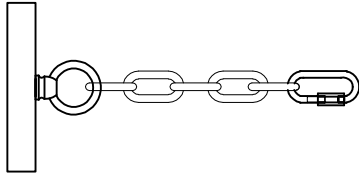

2PCS



1PCS



2PCS

Canopy and hanging chain 1PCS

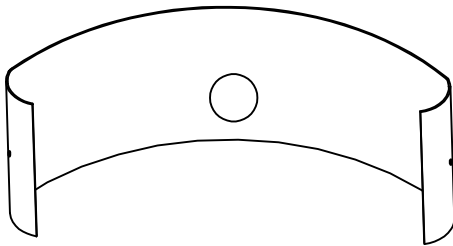

bend sheet metal 8PCS

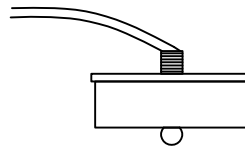

round junction box 1PCS



Cap nut 2PCS

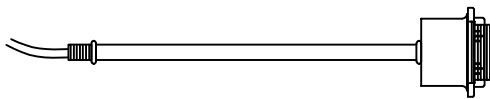

lamp arm 8PCS

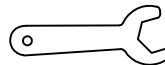

wrench 1PCS

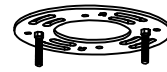

hanging board 1PCS



nut 8PCS



ring washer 8PCS



Suspension ring 1PCS



Spherical cap 8PCS

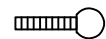

round cap screw 8PCS

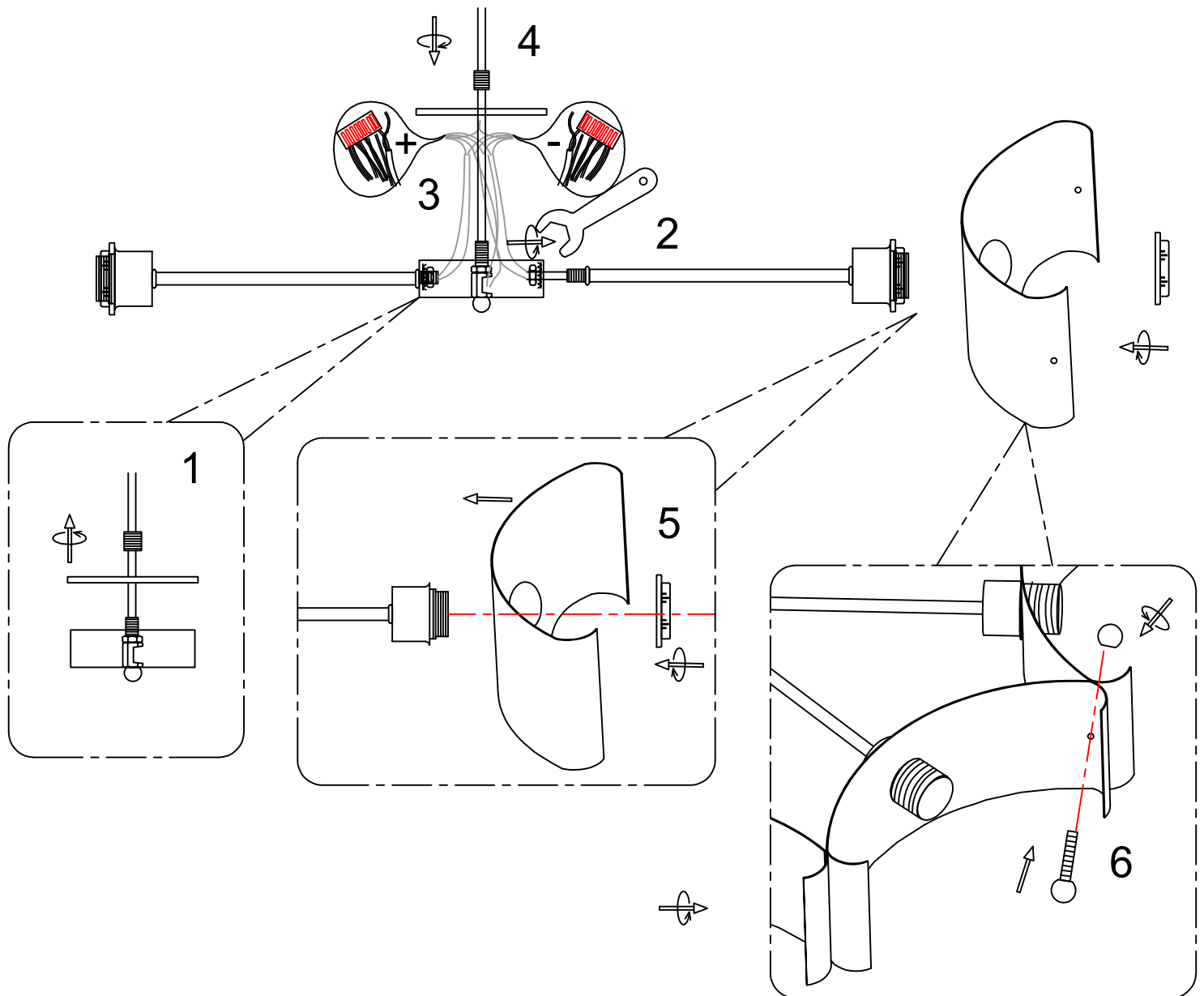

1. Unscrew the inner and outer threaded pipes and remove the cover plate.
2. Pass the lamp arm through the round junction box and secure it with nuts and washers.
3. Distinguish between the positive and negative terminals and use terminal blocks for wiring.
4. Pass the wires through the cover plate and inner and outer threaded pipes, and secure them by tightening the outer threaded pipes.
5. After removing the lamp head ring, use the lamp head ring to secure the bend sheet metal to the lamp head.
6. First, align the round holes on the bend sheet metal, then insert the round cap screw through the round holes and tighten the spherical cap to secure it in place.

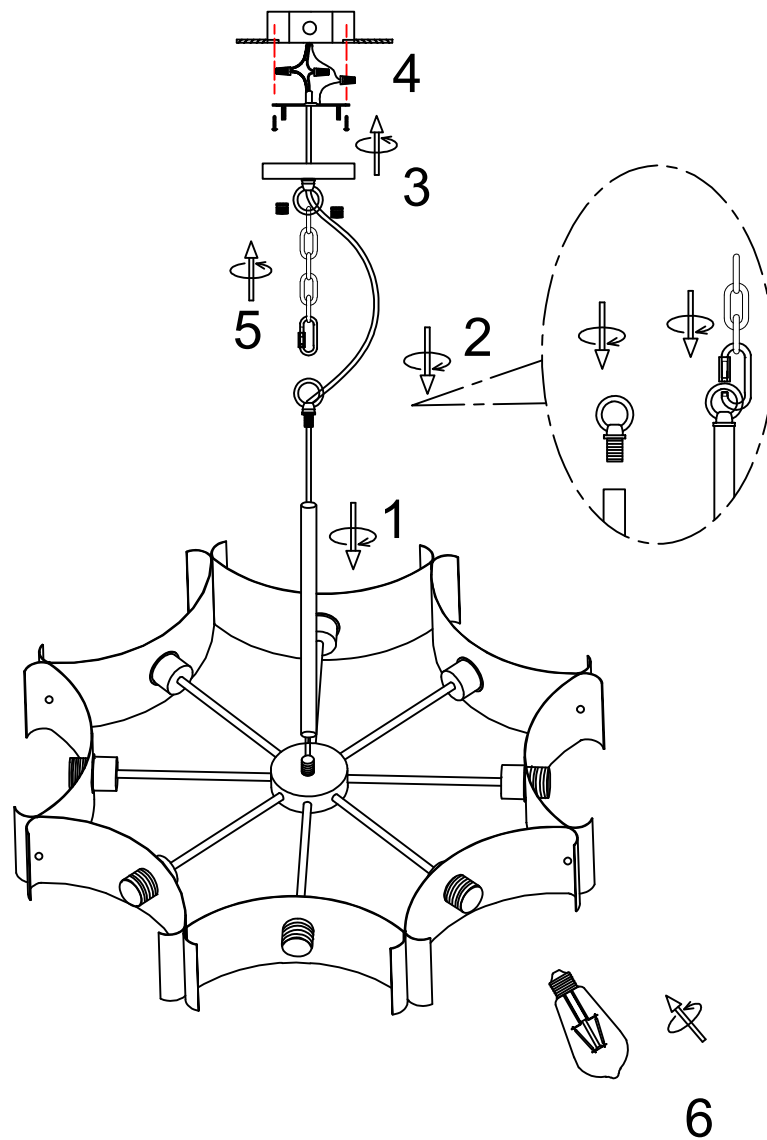

1. Thread the electric wire through the suspension tube and rotate the tube to tighten it.
2. After the electric wire passes through Suspension Ring , tighten Suspension Ring to secure it to the suspension tube. Then, pass the sling chain through Suspension Ring and tighten the nut on the sling chain to secure it.
3. Install the hanging board on the ceiling junction box.
4. Connect the wires to the home circuit and distinguish between positive and negative.
5. Install the light fixture onto the suspension plate and tighten with cap nuts.
6. Twist the light bulb onto the lamp head.

Please read carefully before installation!!!

Note : Please make sure that the electricity is powered off during installation ! Only a professional electrician should install this kind of product !

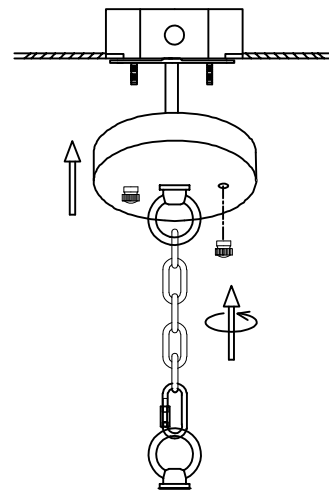
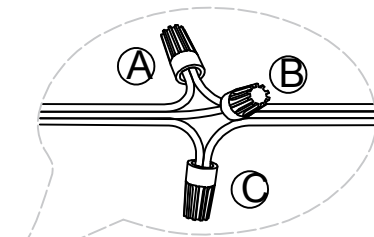
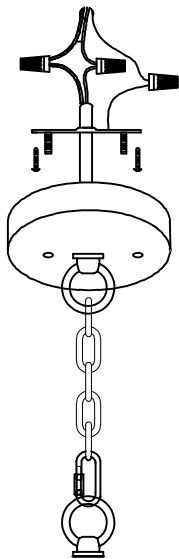
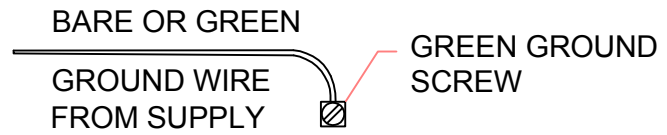
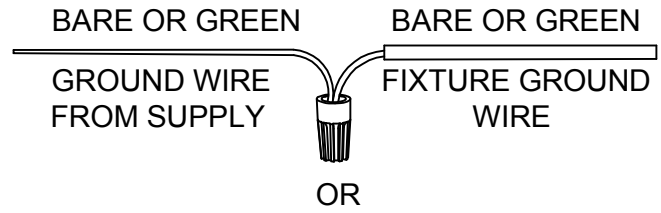
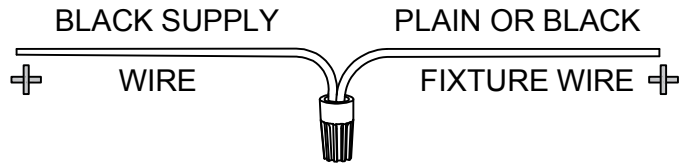
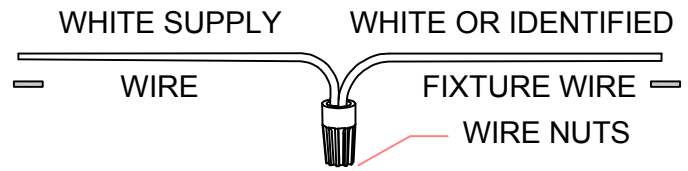
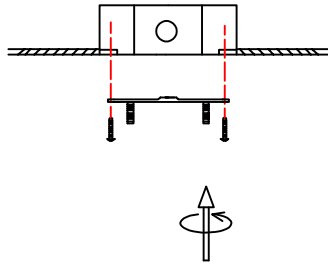

Disclaimer

Read this disclaimer completely and carefully before proceeding with the rest of the manual content.

1.Product Modifications

Any modifications or alterations to this product void any warranties and may result in damage or injury. We shall not be liable for any damages resulting from such modifications or alterations.

2.Compliance with Laws

Customers shall be liable for ensuring that the use of this product complies with all applicable laws and regulations in their respective jurisdictions. We shall not be responsible for any violations of laws or regulations resulting from the use of this product.

3.Correct Use

Always use this product only as directed in the accompanying manuals. Failure to follow instructions may result in injury or damage.

Always ensure the assembly, installation, operation, maintenance, or repair of this product is carried out by a competent person.

Regular maintenance should be performed throughout the lifecycle of this product. You are responsible for ensuring this product operate as intended. Always wear appropriate protective gear.

4.Third-Party Products

We shall not be liable for any damages or losses resulting from the use of third-party products in conjunction with our products. Customers shall refer to the third-party' sguidelines or/and warranties (if any) for any third-partyproducts used.

5.Limitation of Liability

We shall not be liable for any direct, indirect, punitive, incidental, special, or consequential damages to property or life, whatsoever arising out of or connected with the use or misuse of our products. In no event shall our liability exceed the value of the products sold.

6.Warranty

Refer to the sales page for warranty information.

This disclaimer states the entire obligation of us with respect to this product. If any part of this disclaimer is determined to be void, invalid, unenforceable, or illegal, including but not limited to the warranty disclaimers, liability disclaimers, and liability limitations set forth above, the invalid or unenforceable provision will be deemed superseded by a valid and enforceable provision that most closely matches the intent of the original provision and the remainder of the agreement shall remain in full force and effect.