

ASSEMBLY INSTRUCTION

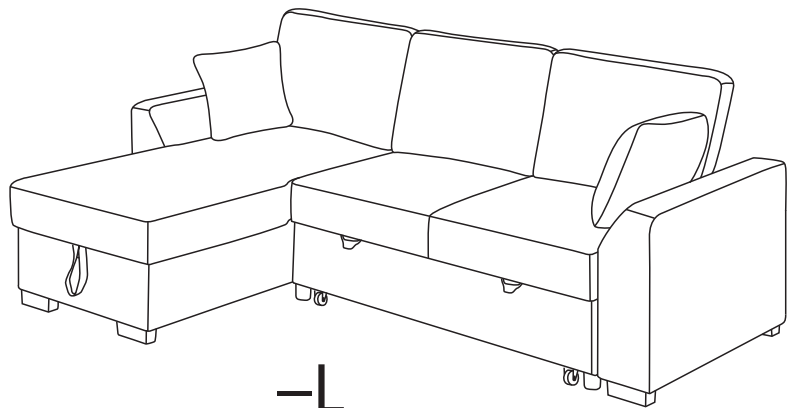

-L

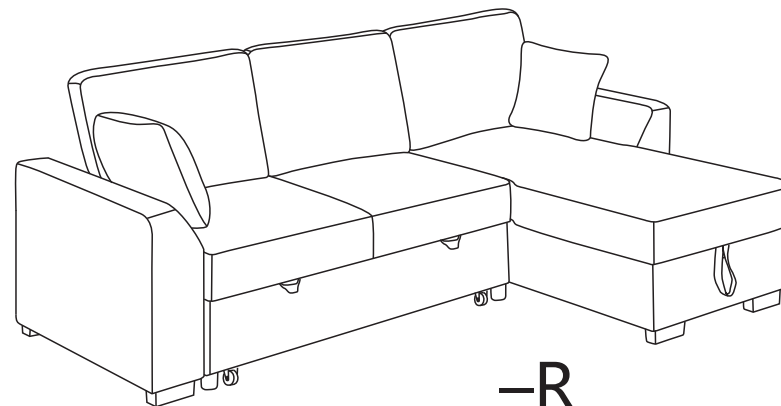

-R

PARTS LIST

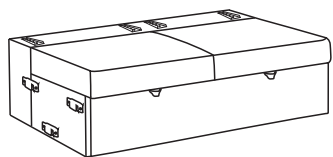

A

X1

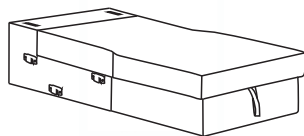

B

X1

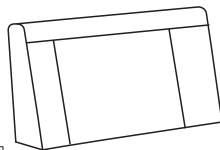

C

X2

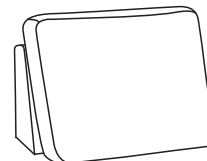

D

X1

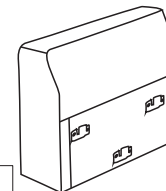

E

X1

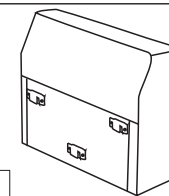

F

X1

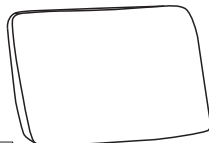

G

X2

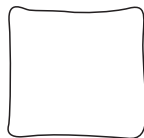

H

X2

HARDWARE LIST

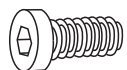

M6X25

1 X8



M4

2 X1

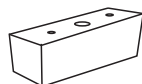

150x60x50mm

3 X6



4 X4

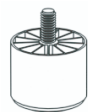

∅60x50mm

5 X6



M8X60

6 X6



M5

7 X1



M5X50

8 X12



9 X1

BOX -1 HARDWARE LIST

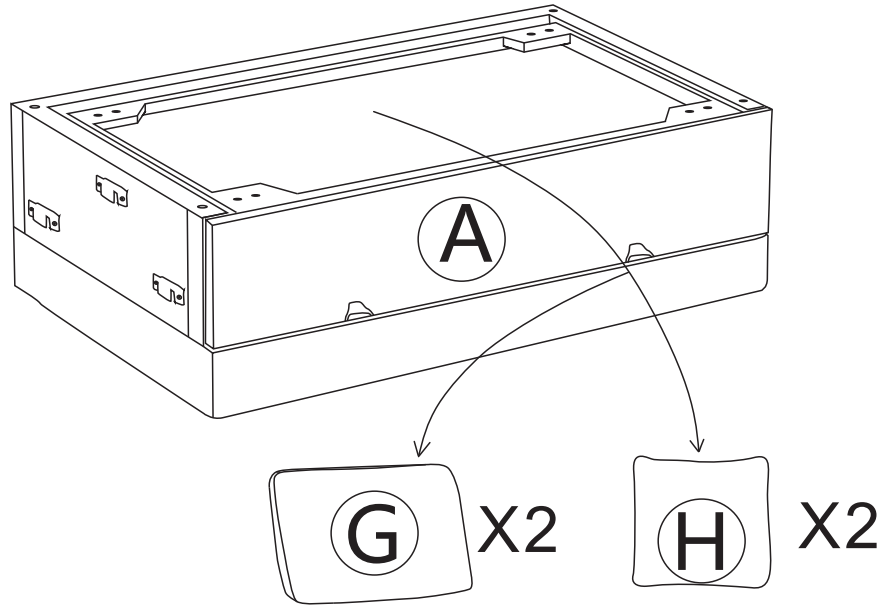

BOX -2 HARDWARE LIST

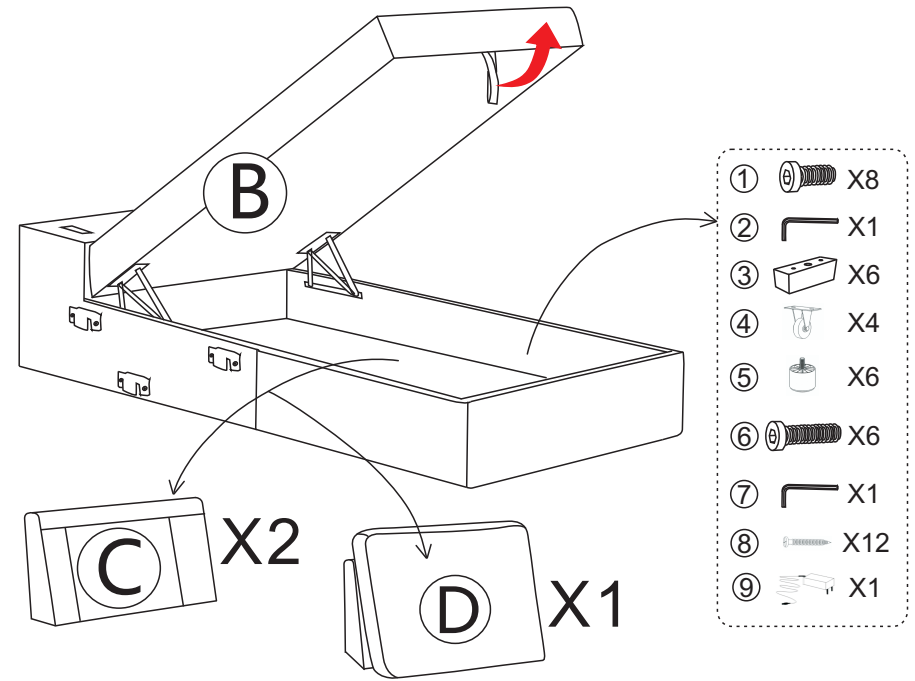

BOX -3 HARDWARE LIST

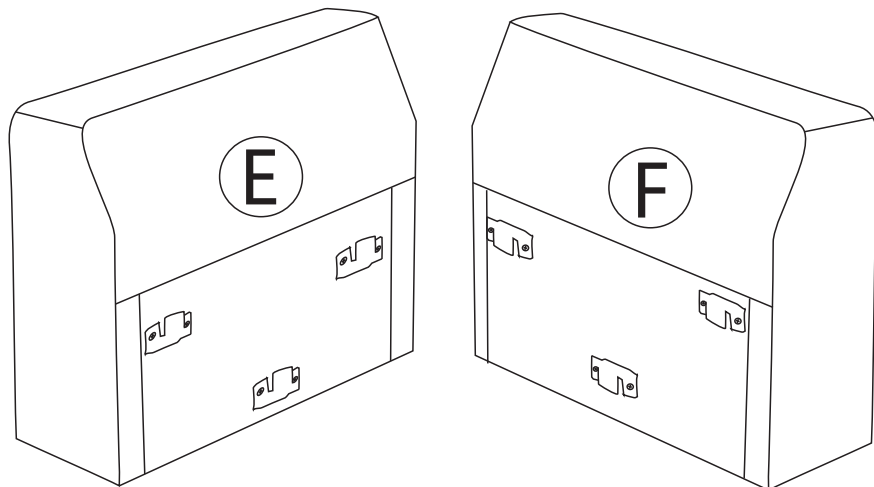

Unpacking steps:

1. BOX-2
2. BOX-1
3. BOX-3

Step1-L/R

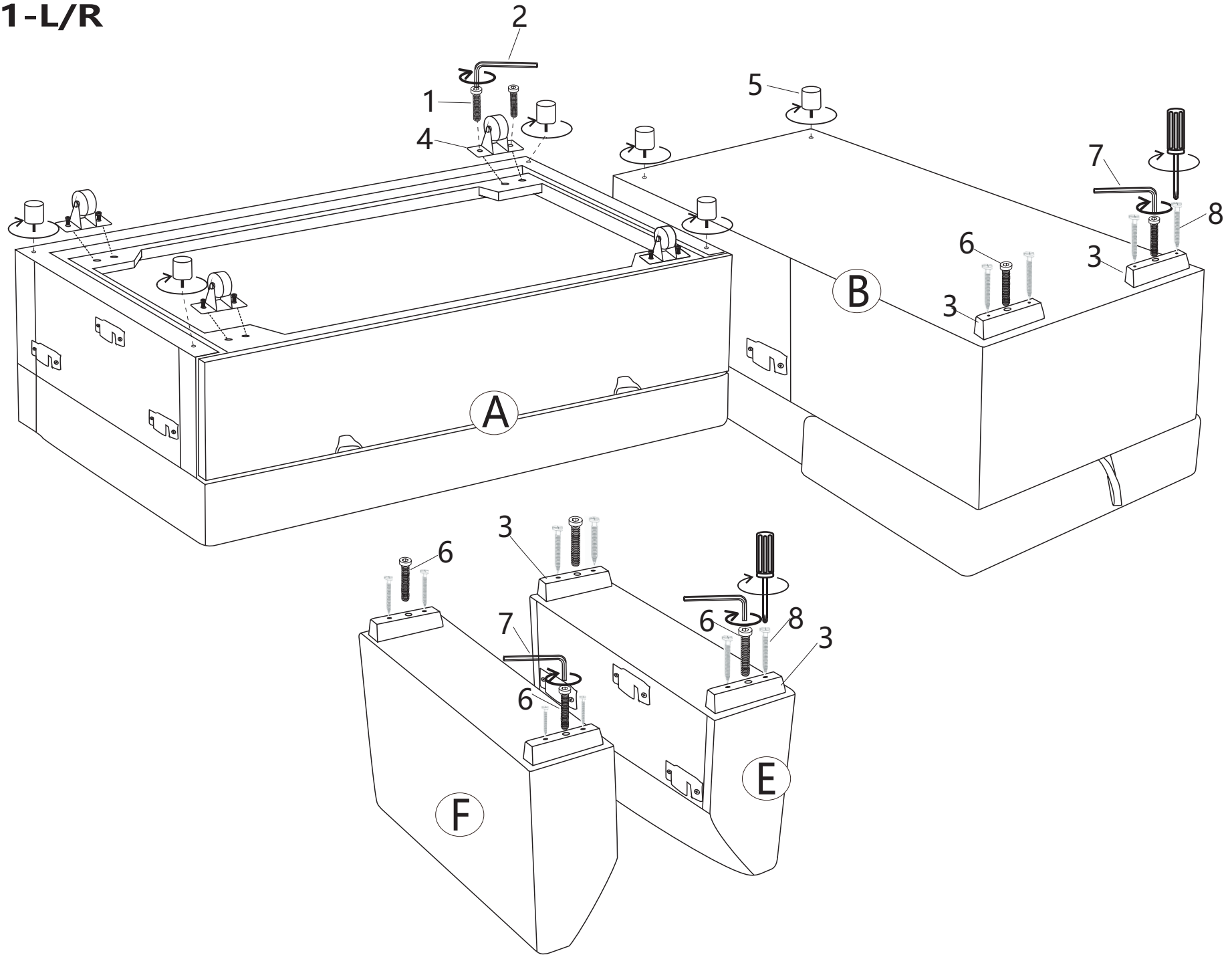

Step2-L

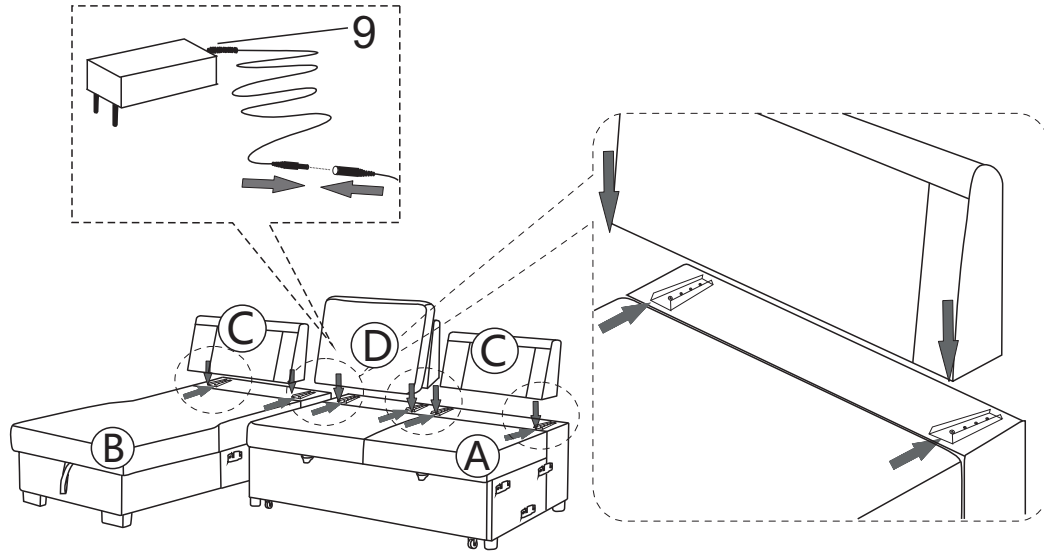

Step3-L

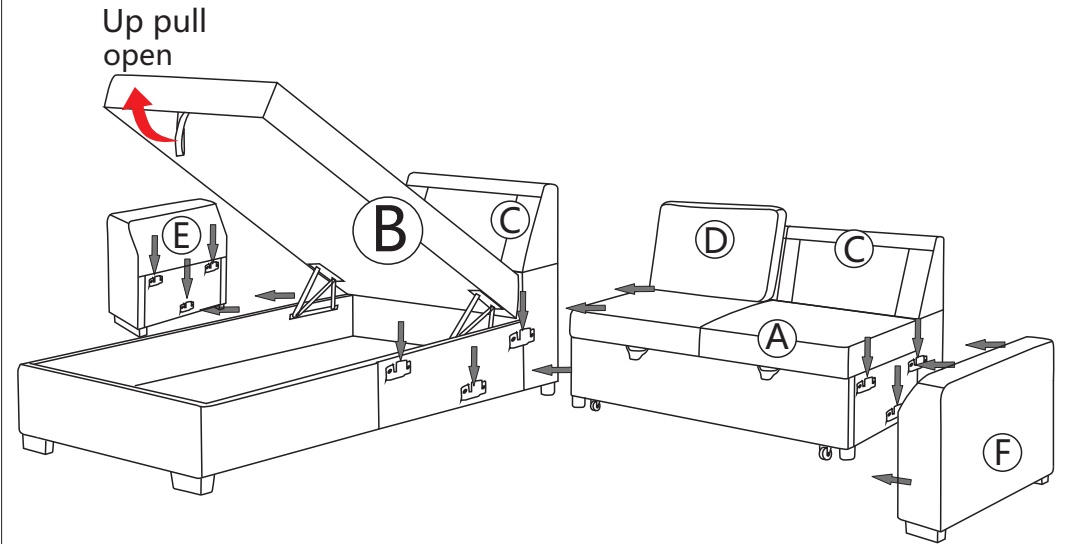

Step4-L

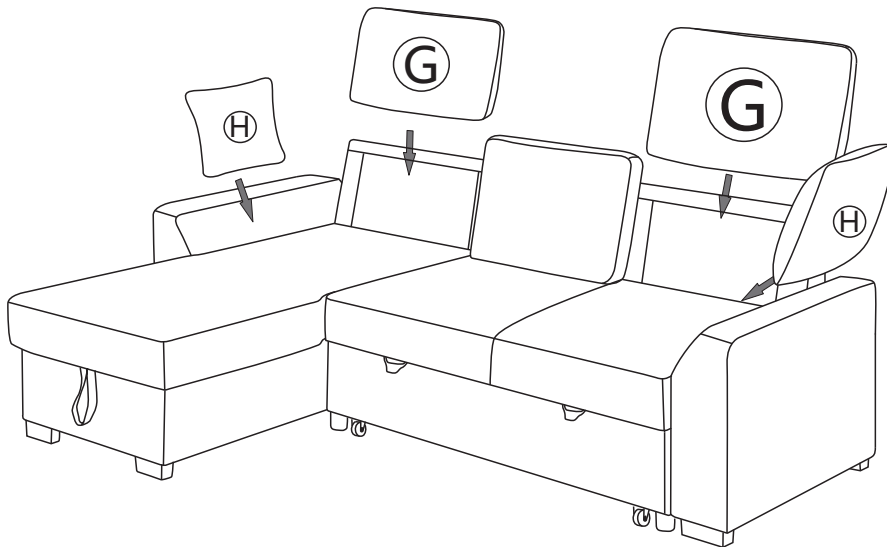

Step5-L

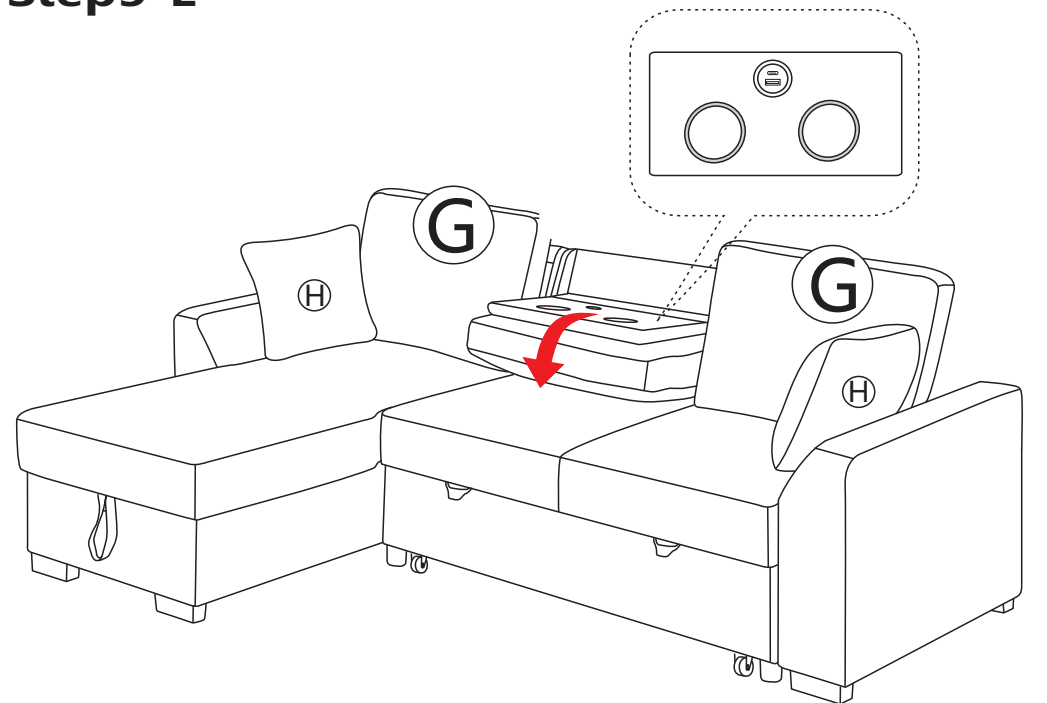

Step6-L

Up pull
open

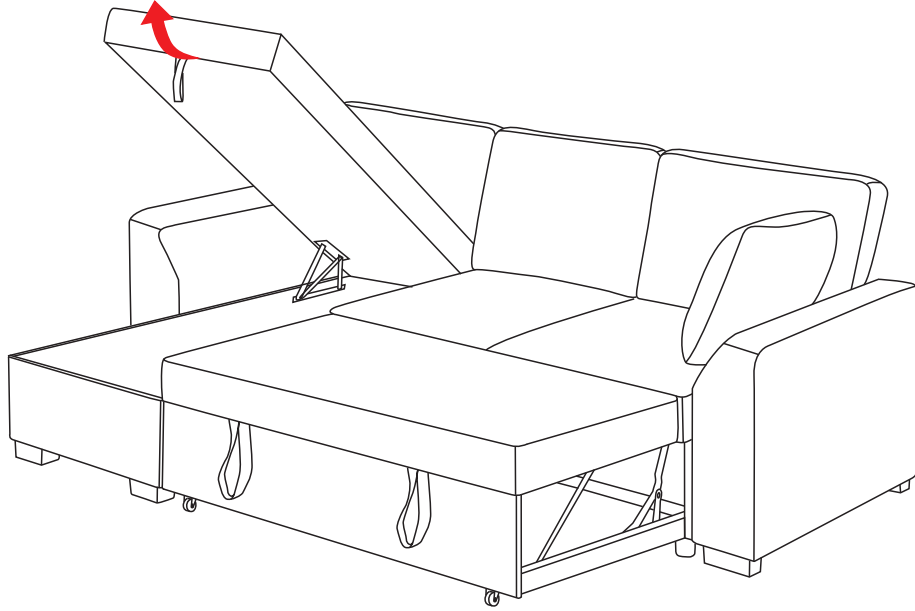

Step7-L

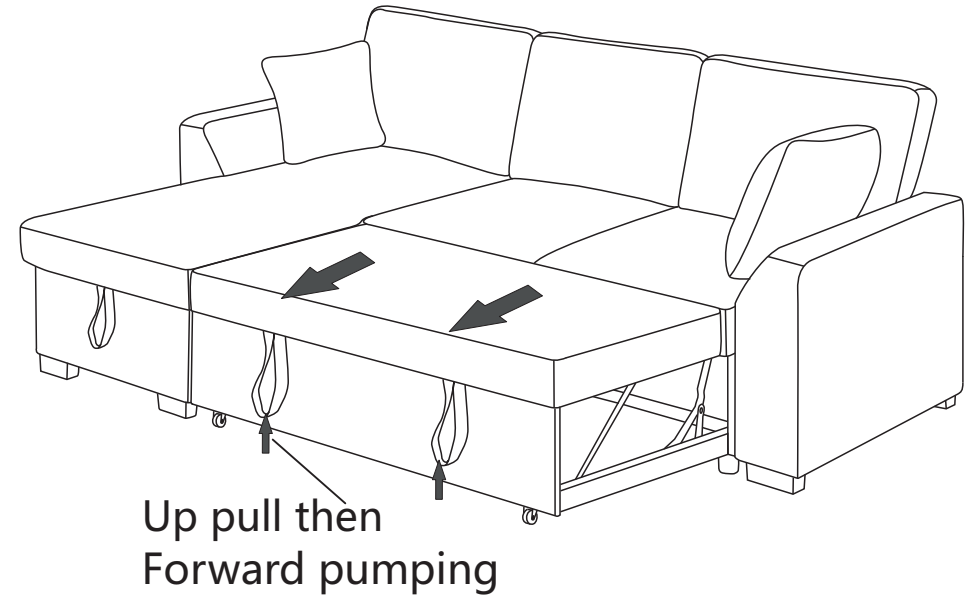

Step2-R

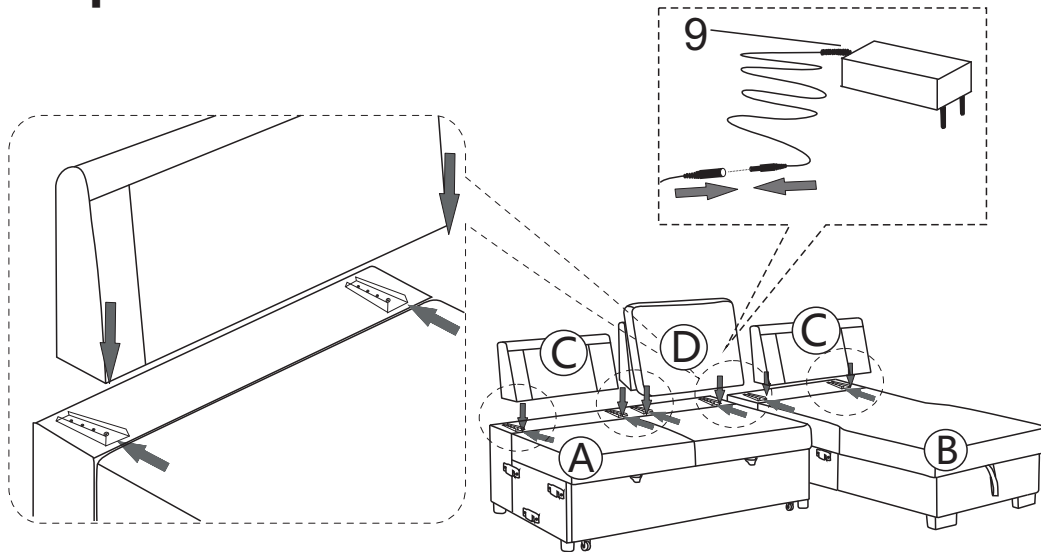

Step3-R

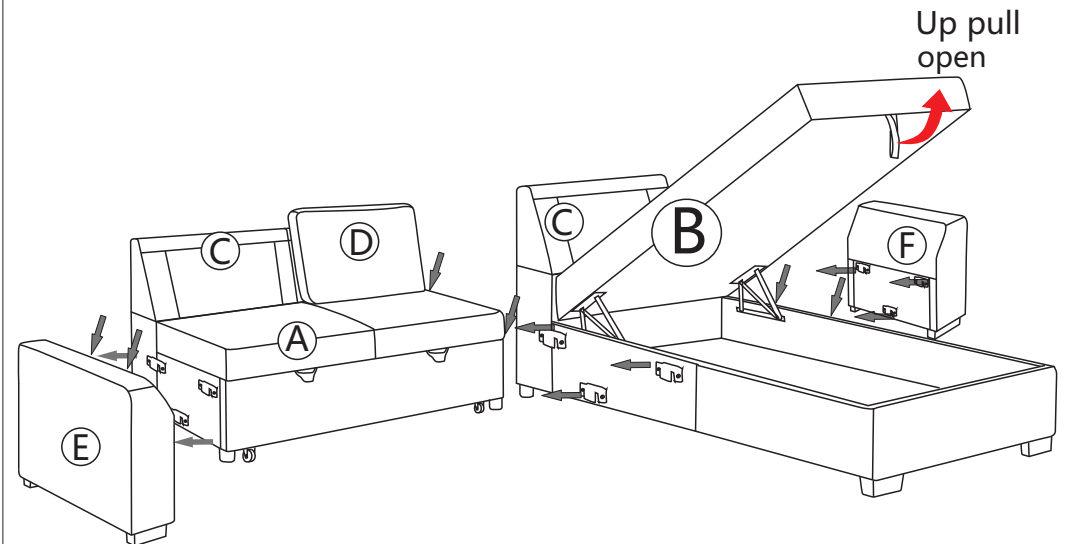

Step4-R

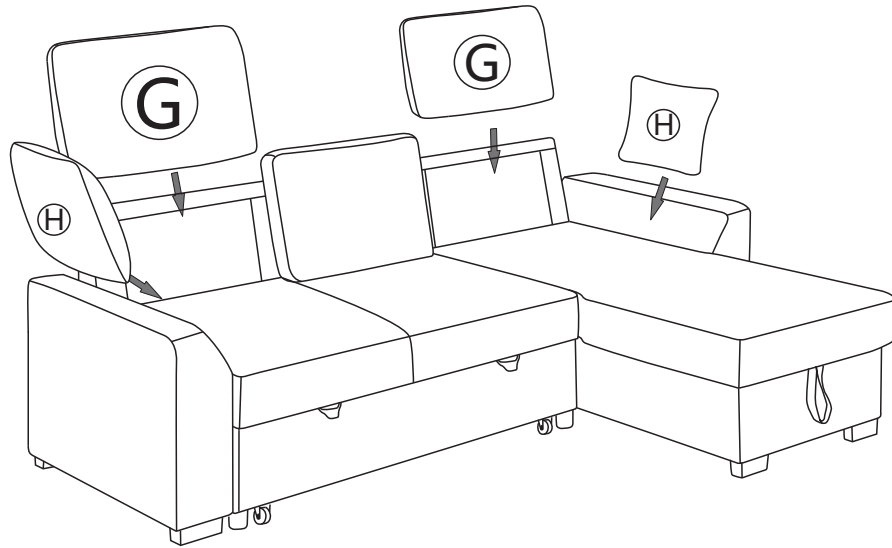

Step5-R

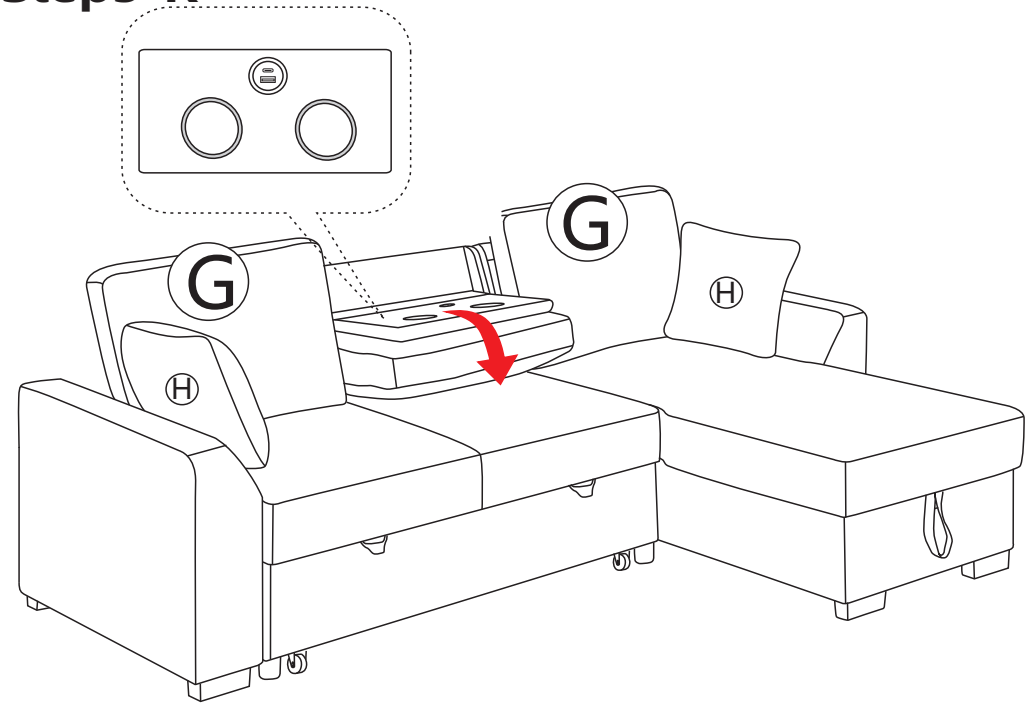

Step6-R

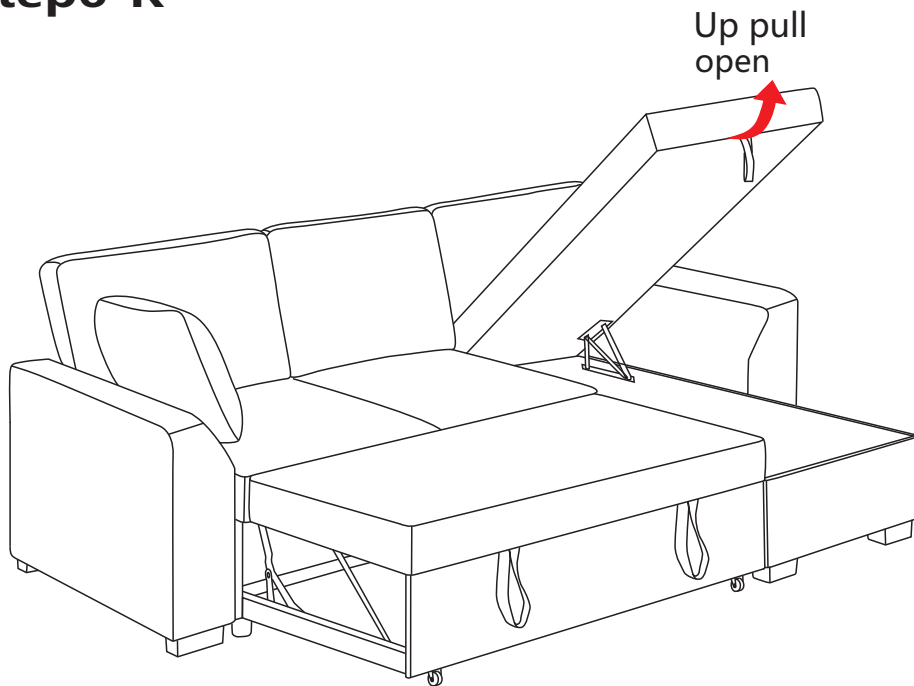

Step7-R

