

# 8\*10ft Garden Metal Storage Shed Installation Instructions

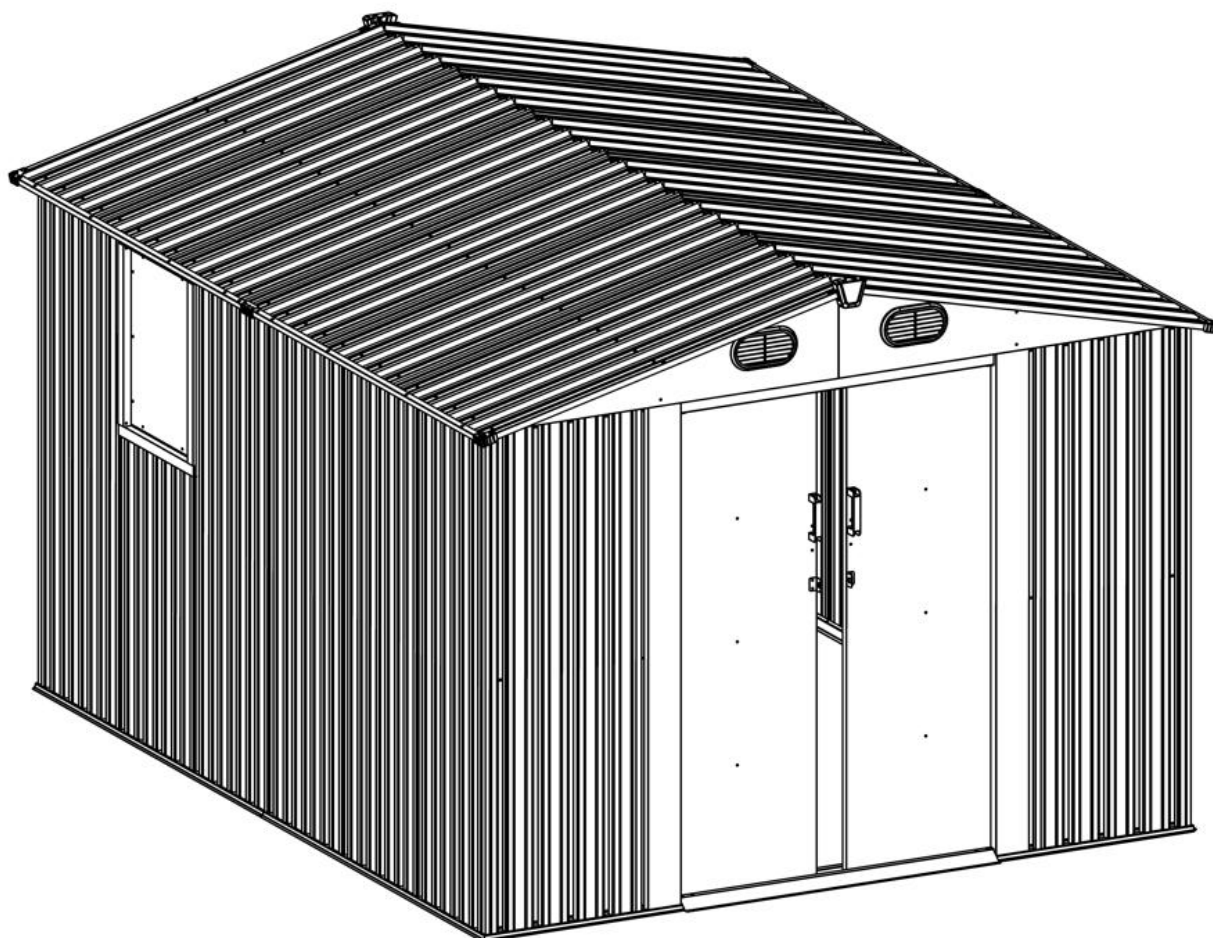

**Thank you for choosing us!**

Our goal is to provide high quality outdoor furniture with outstanding customer service all at an affordable price.

Please let us know if you have any concerns.

Please wear gloves to avoid injury!

**The product comes in two cartons. Please install after receiving all cartons.**

Please prepare below tools before installation. (Not Included)



Electric Screwdriver

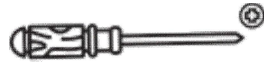

+ Manual Screwdriver



Ladder



Spanner

#### Package included Tools



Gloves X 1 Pair

## ATTENTION:

1. Please read this instruction carefully before installation and follow it strictly during installation.
2. Ensure that there are no problems later due to installation errors.
3. We have prepared extra screws for you to use in case of loss or damage.

## Installation Notes

Please check the quantity of all parts before installation (refer to the Parts Lists) and the appearance of the products. Make sure the product is correct before installation.

Make sure the colored panels are facing outwards and all the holes match. The panels are textured, please install the panels in the order specified in the instructions. All lines and holes should be matched to make the storage shed more stable. Please ensure that all screws are tightened to prevent the product from falling apart.

There is a protective film on the surface to protect the product, you can tear it off after installation. If you do not damage the film during installation, it can also remain on the product to protect.

Please place the product on a flat ground to prevent leaning and collapse. If the ground is uneven, the door may can't be closed.



## Safety Precautions















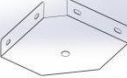
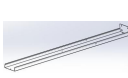

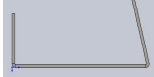

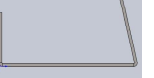

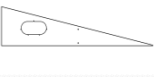

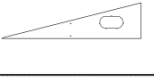







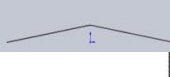











We recommend **two adults** to complete the installation. Two adults installed together will make the installation process easier and safer.











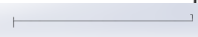

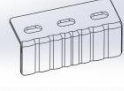













The gloves must be carried to prevent hand cuts during installation.

Take care when using power tools near water the use of a residual current device (RCD) is advised. Please use the electric driver carefully during screwing to prevent the screw from slipping and hurting your hand. (We recommend that beginners use a manual screwdriver for installation.) Be careful not to fall when installing the roof. Please steady the ladder and make sure the product placed on a flat ground.

**PLEASE KEEP THIS INSTRUCTION FOR FUTURE REFERENC**

# Packing list

Part	No	Qty	Part	No	Qty	Part	No	Qty
	4L	1		9R	1		E5	2
	4R	1		14	2		E6	1
	1L	2		ABL	2		E7	2
	1R	2		ABR	2		E8	2
	2	1		APL	2		E9	12
	3	1		APR	2		S1	4
	5	1		PL	4		S2	8
	P1	4		AP2	12		F4	20
	P3	2		AP5	2		F1	562
	P2	11		AP6	4		F6	106
	P4	1		AP7	4		F2	106
	P5	2		C2	2		F12	4
	13L	1		C3	2		F8	182
	13R	1		C4	4		F7	412
	A1	1		CL	2		RC2	4
	A2	1		CR	2		GF	4

	8	1		D1	1		RT3	2
	7	1		D2	1		RC3	2
	10R	2		D3	4		F9	8
	12L	1		D4	2		F10	8
	12R	1		D5	4		F5	8
	10L	2		D6	4		D9	2
	11L	2		D7	2		W1	1
	11R	2		D8	4		W2	1
	9L	1		E1	1		W3	2
	24	2		E3	1		W4	8
	F17	4		E4	2		W8	1
	AP8	2		P6	1			

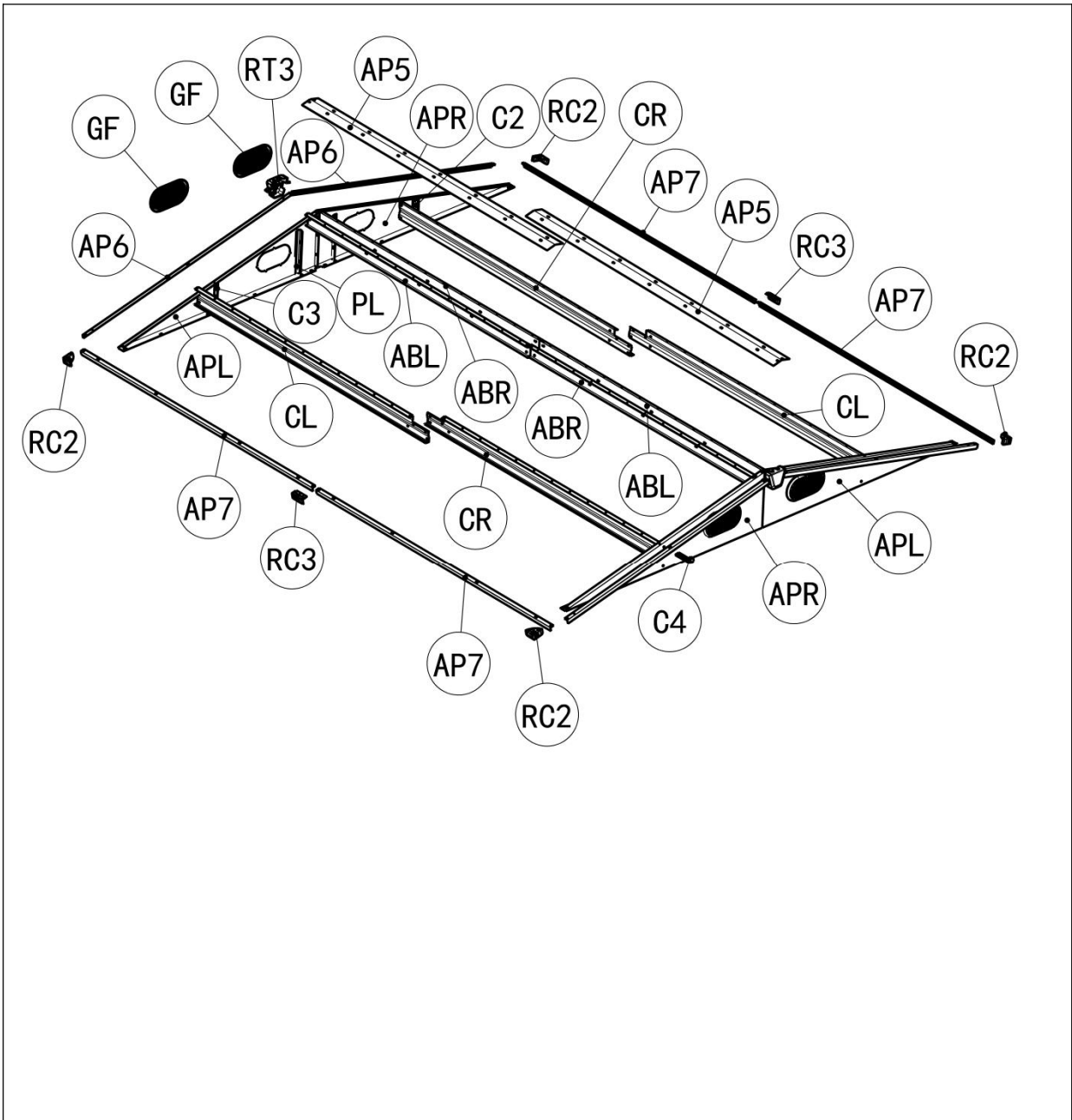

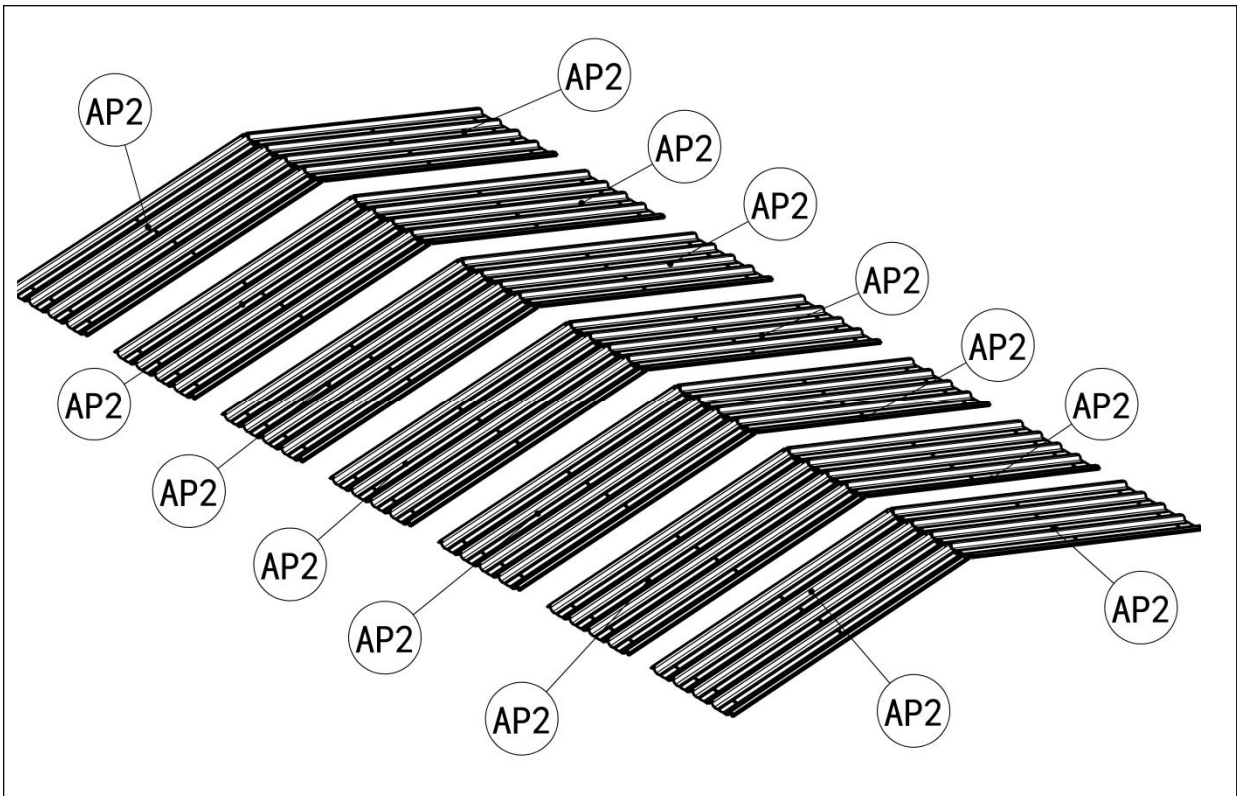

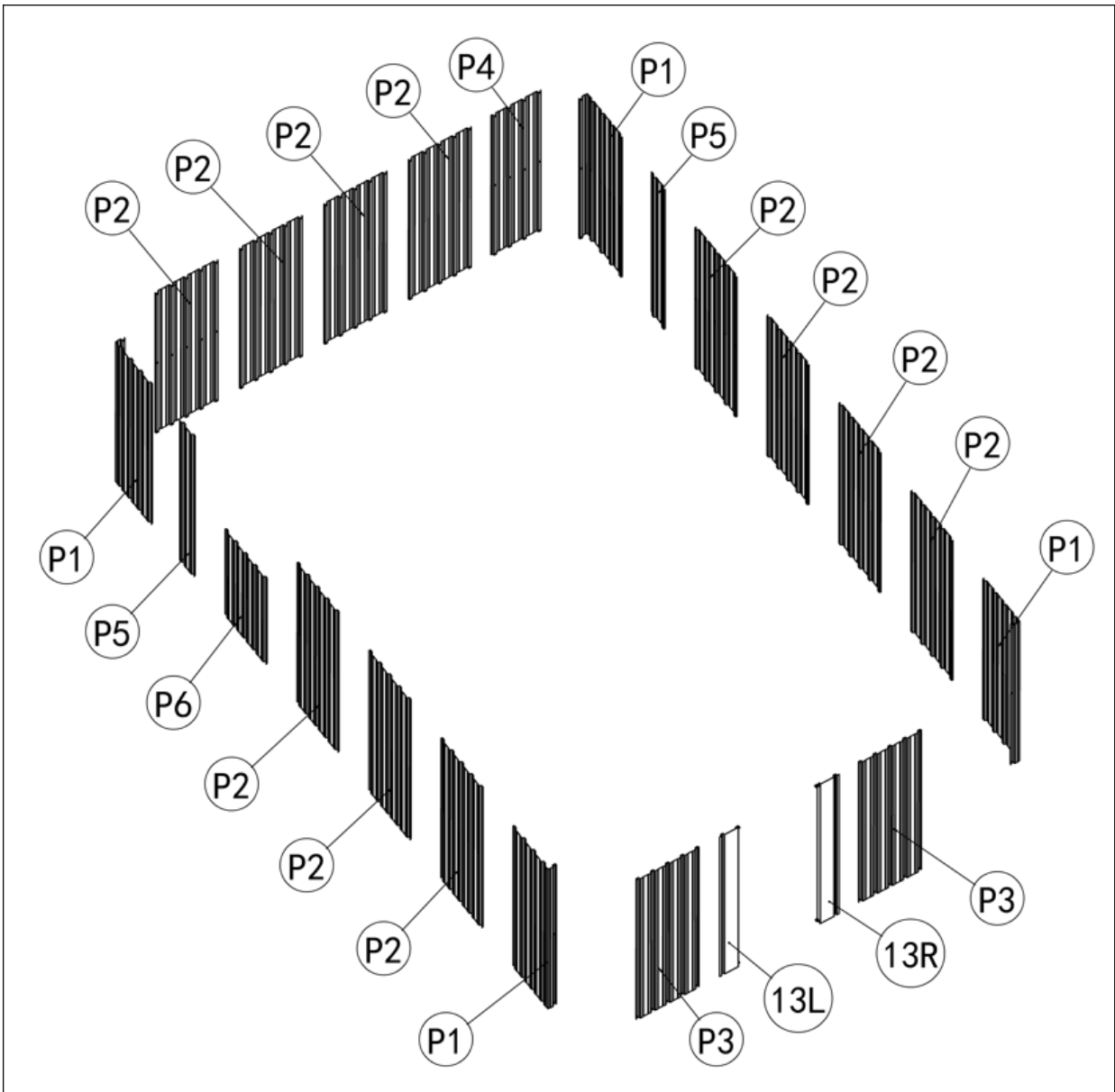

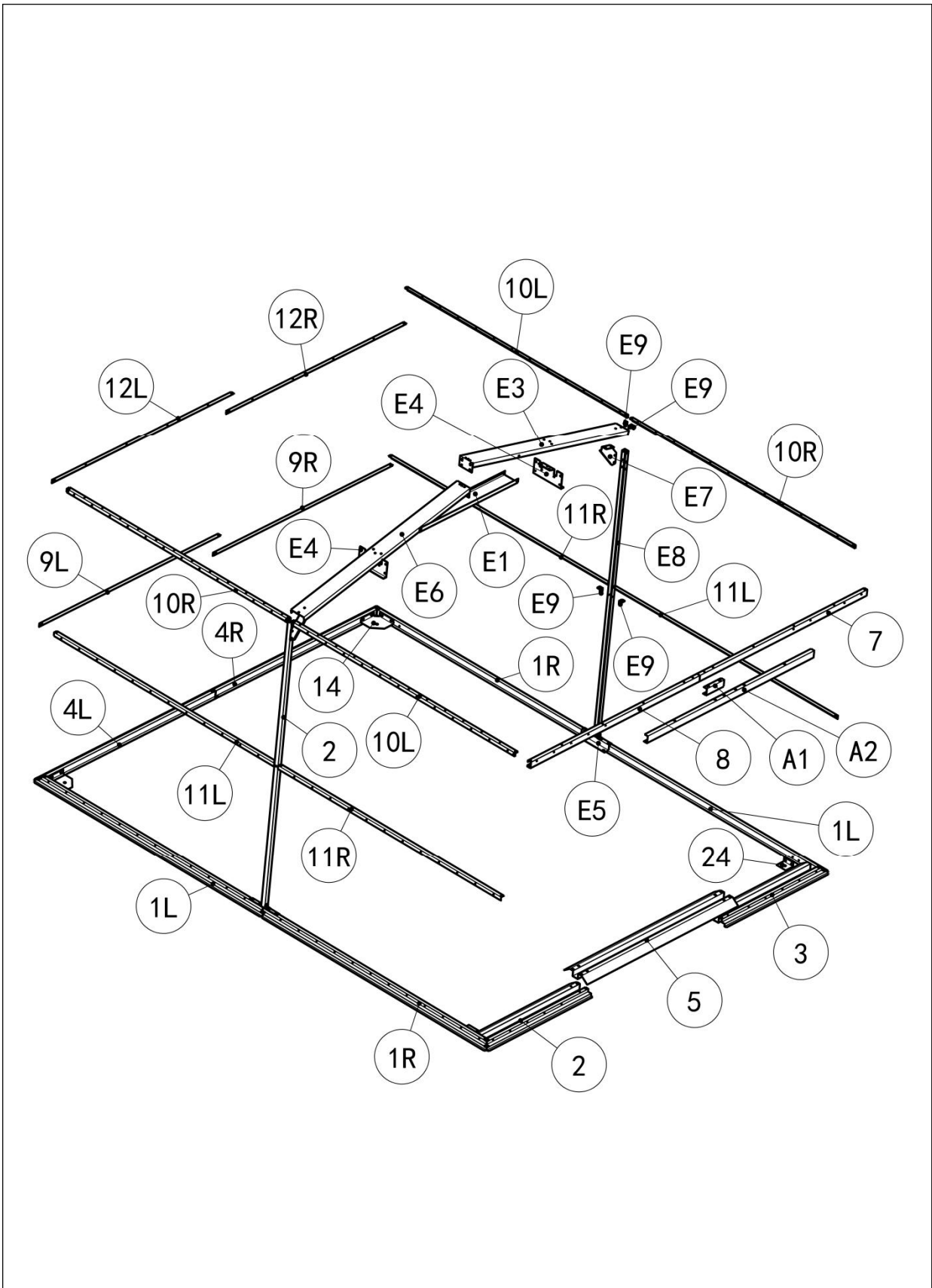

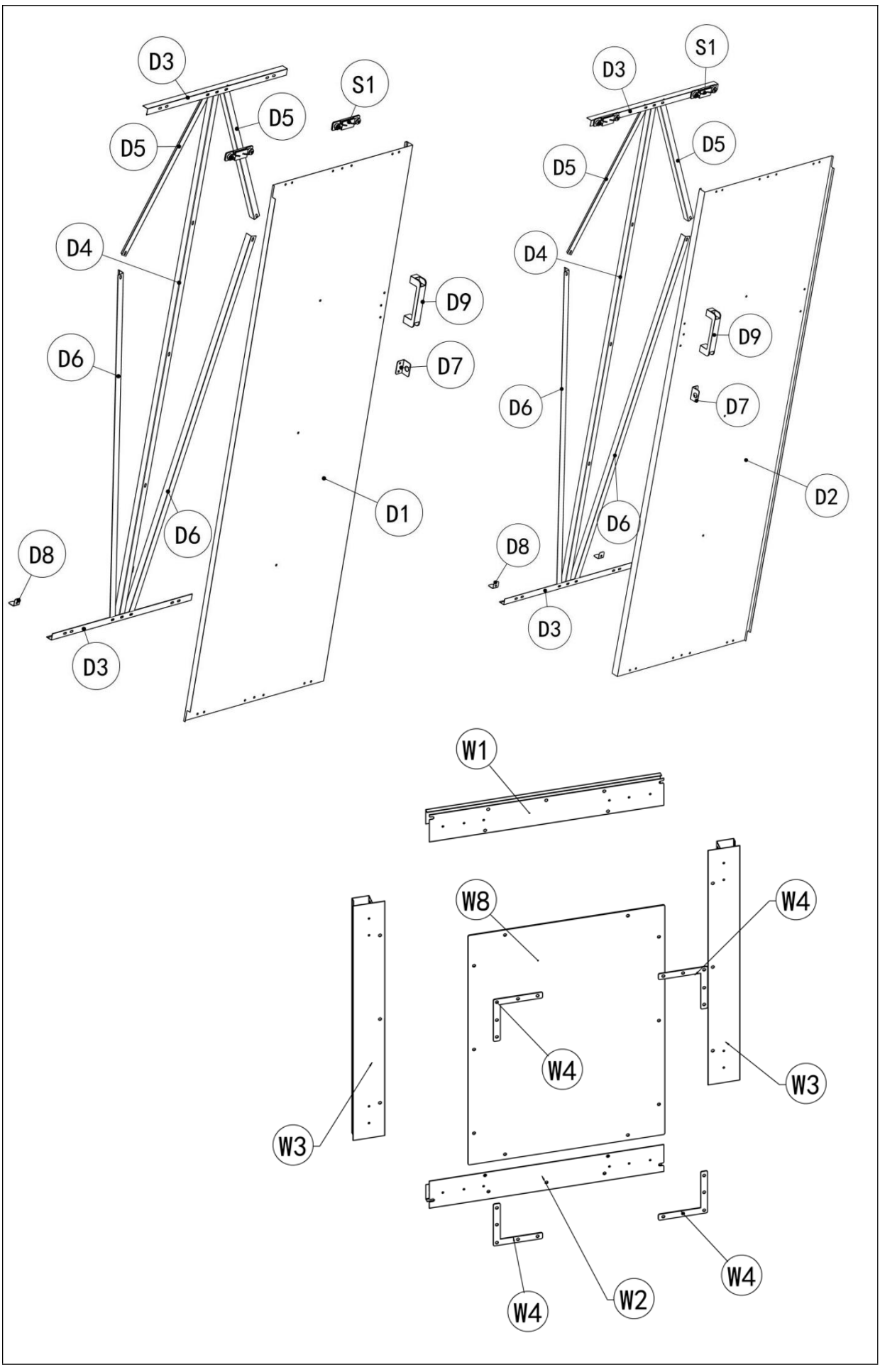











# 1、 Base Frame Assembly

1、 Use F1 screws to connect 2、 5、 3

2、 Use F1 screws to connect 2、 3、 1L、 1R、 4L、 4R

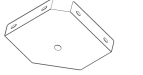
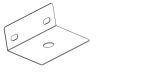
3、 Use F1 screws to connect 2、 3、 4L, 4R and fasten 14, 24 into the four corners.



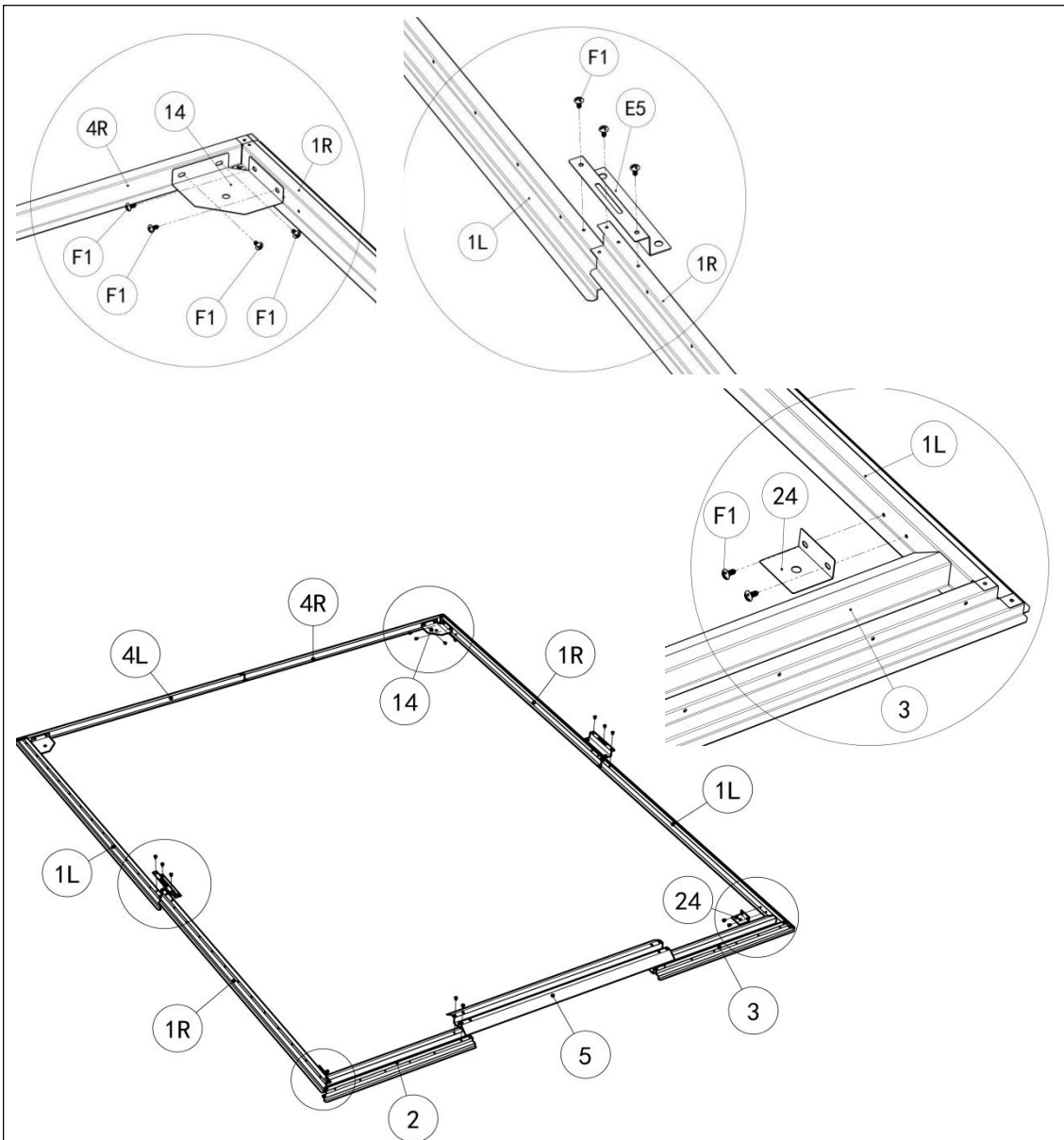



























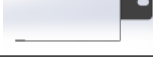





Part	No	Qty	Part	No	Qty	Part	No	Qty
	4L	1		1R	2		5	1
	4R	1		2	1		F1	38
	1L	2		3	1		14	2
	24	2		E5	2			

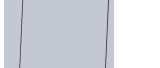

## 2、 Wall Assembly

1. Fasten P1 into the base with F1 and F7.
2. Connect 9L, 9R, 10L, 10R, 11L, 11R, 12L, 12R into P1 with F1 and F7. Use F2 and F6, F1, E7, E8, E9, connect with 10L and 10R, 11L and 11R, 9L and 9R, 12L and 12R
3. Use F1 to connect 7, 8, A1, A2.
4. Connect P3, 13L, 13R into 7 and 8 with F1 and F7.

5. Connect P2, P4, P5, P6 into the base and 10L, 10R, 12L, 12R, 9L, 9R, 11L, 11R with F1 and F7.

Part	No	Qty	Part	No	Qty	Part	No	Qty
	P1	4		12L	1		F1	298
	P3	2		12R	1		F7	230
	P2	11		10L	2		F9	8
	P4	1		11L	2		S1	4
	P5	2		11R	2		F10	8
	P1	4		9L	1		P6	1
	13L	1		9R	1		W1	1
	13R	1		E7	2		W2	1
	A1	1		E8	2		W3	2
	A2	1		E9	12		W4	4
	8	1		F6	4		W8	1
	7	1		F2	4		F2	8
	10R	2		F5	8		F6	8

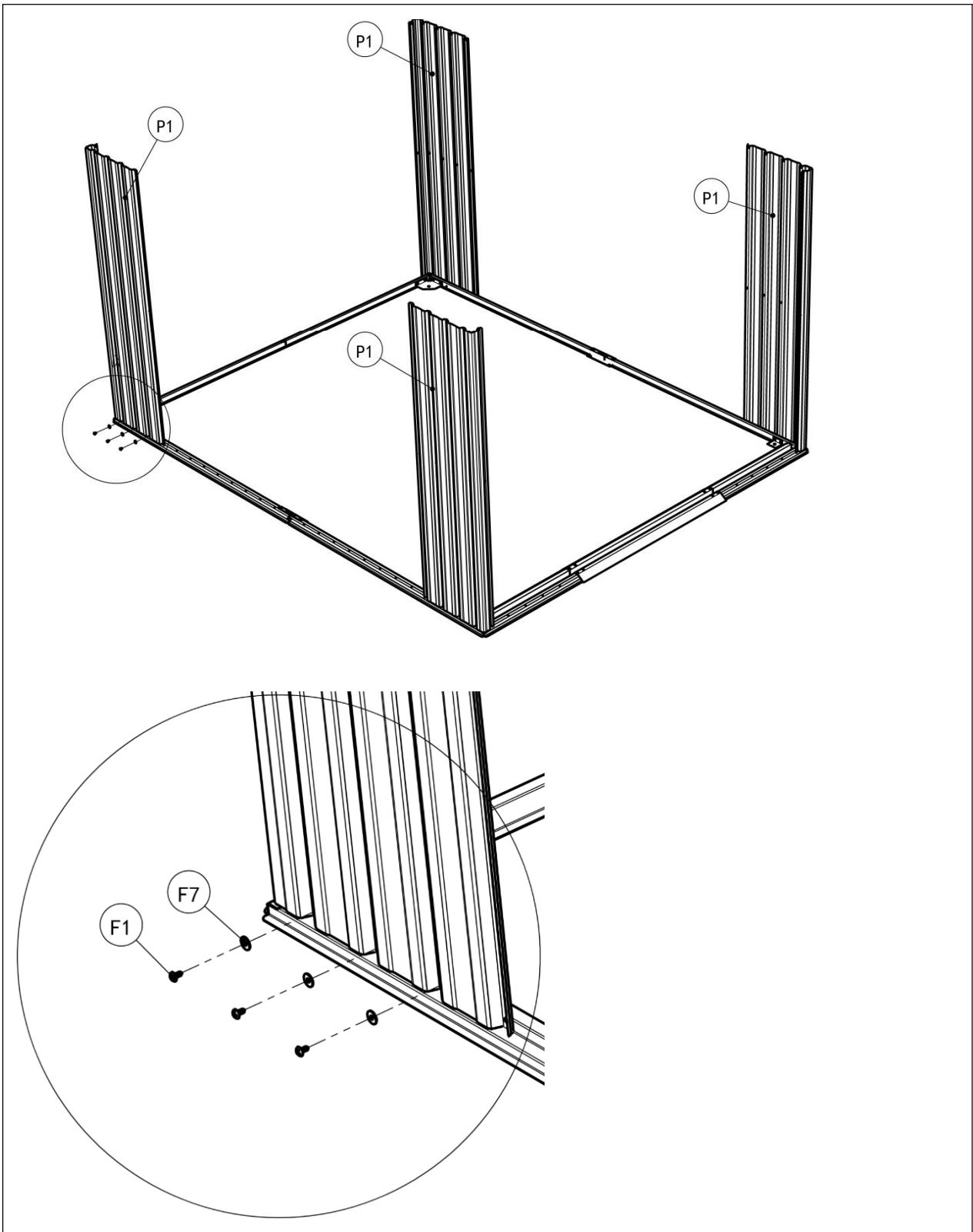

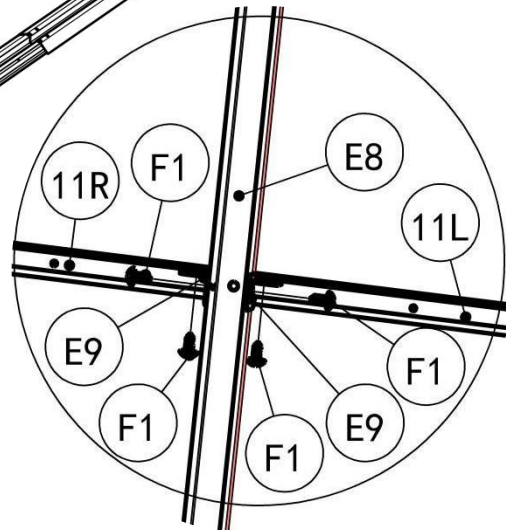
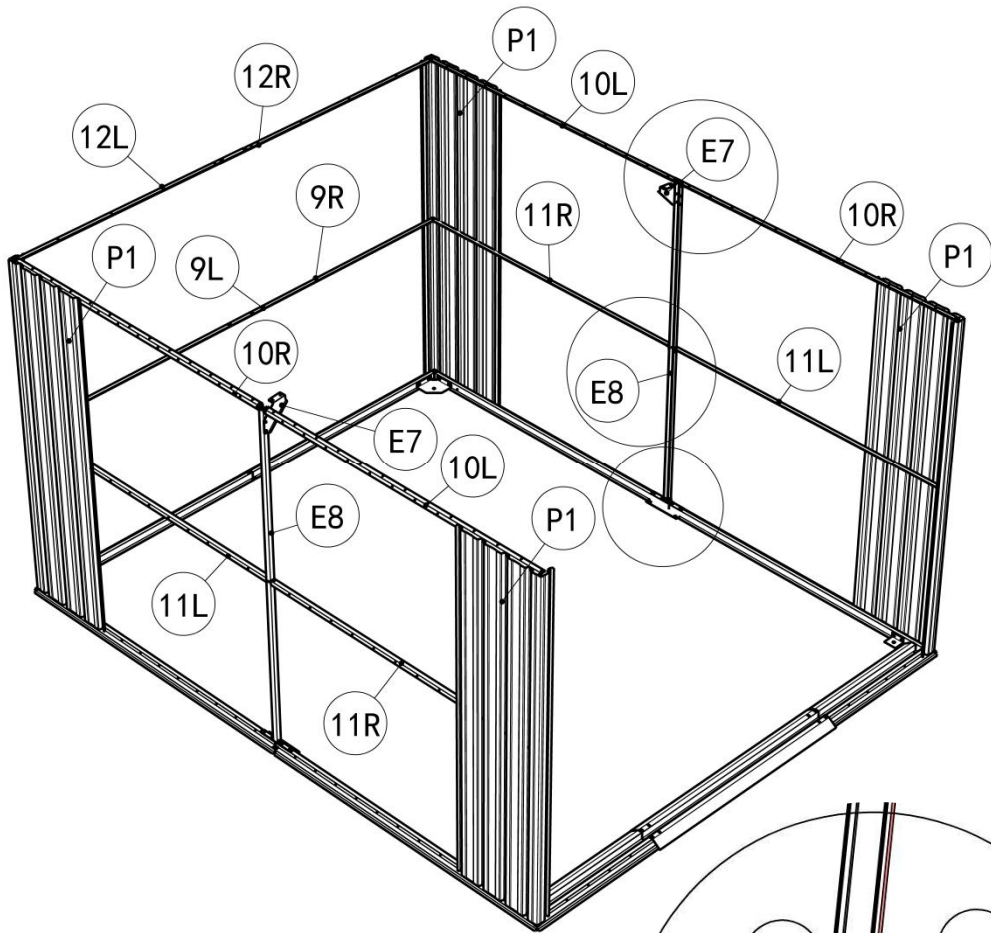
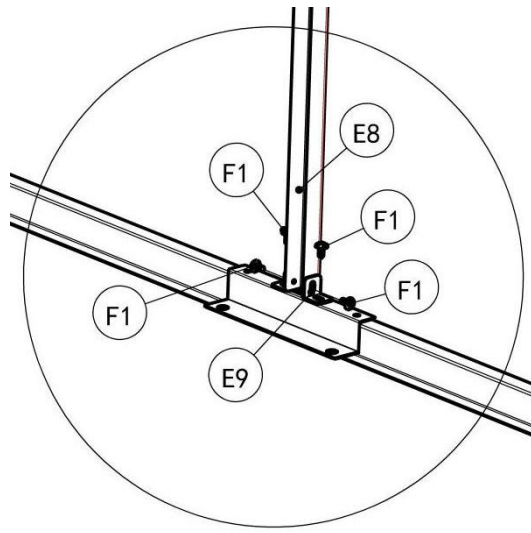
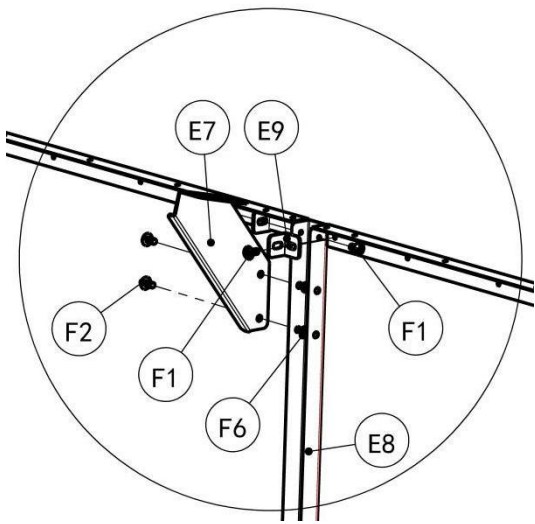

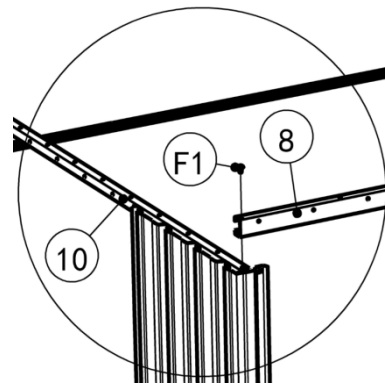
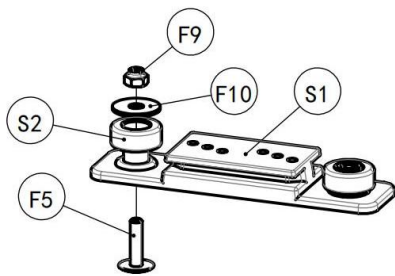
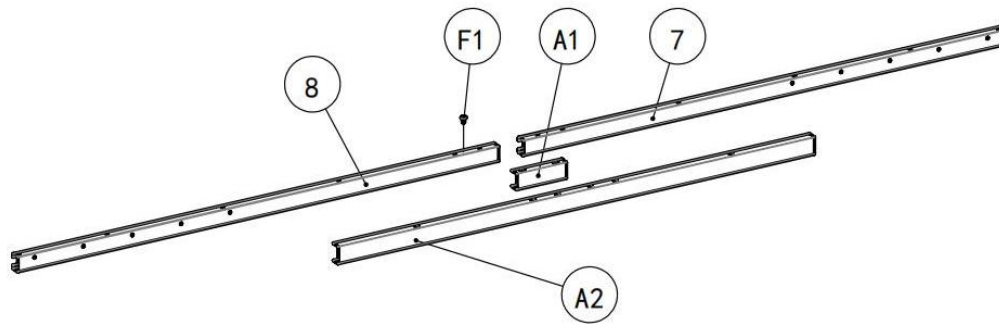

Note: Put S1 and S2 into 7&8 in advance.

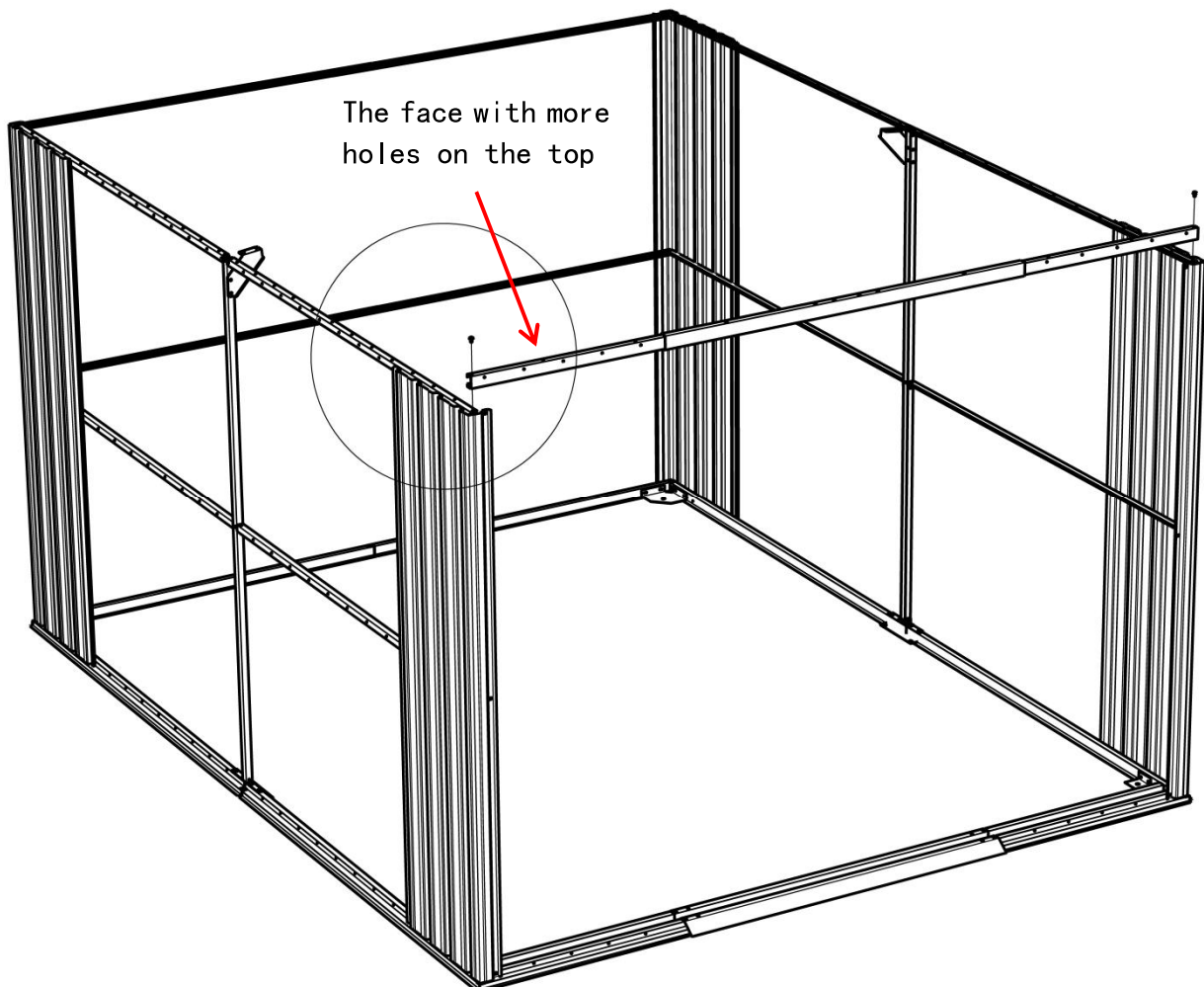

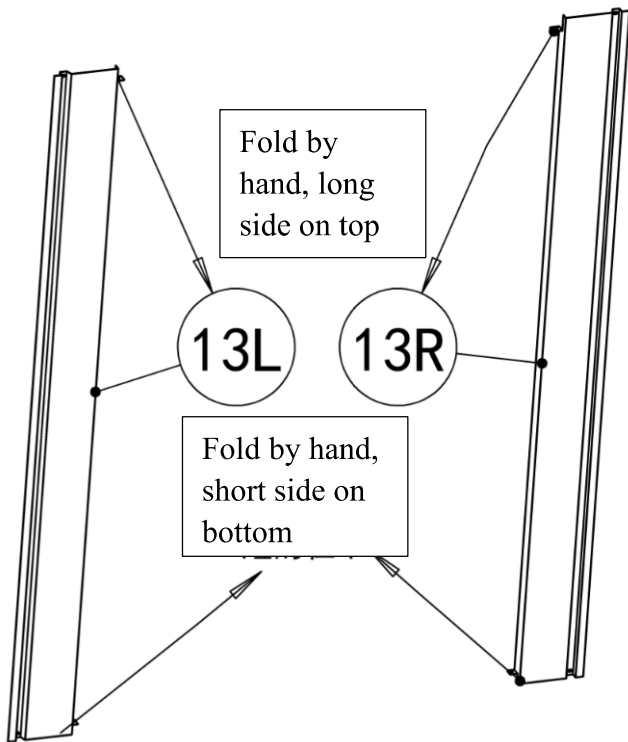
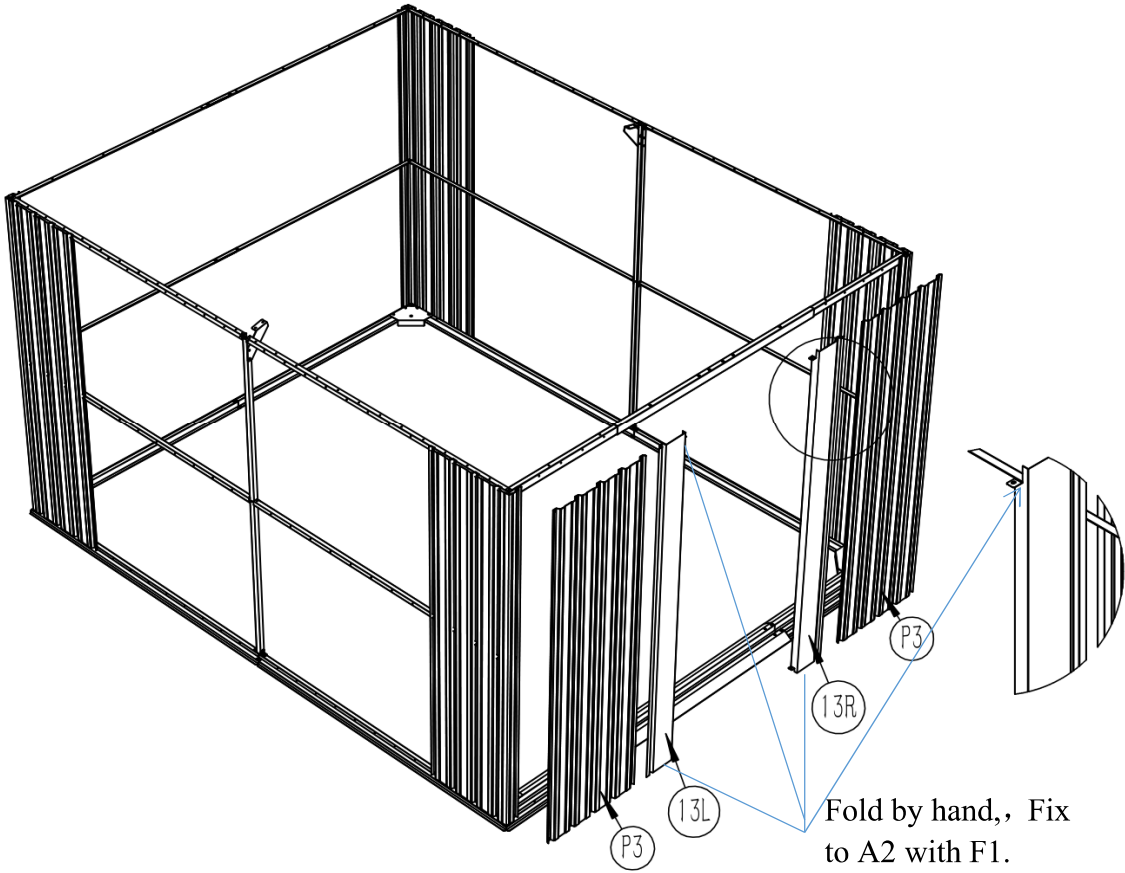

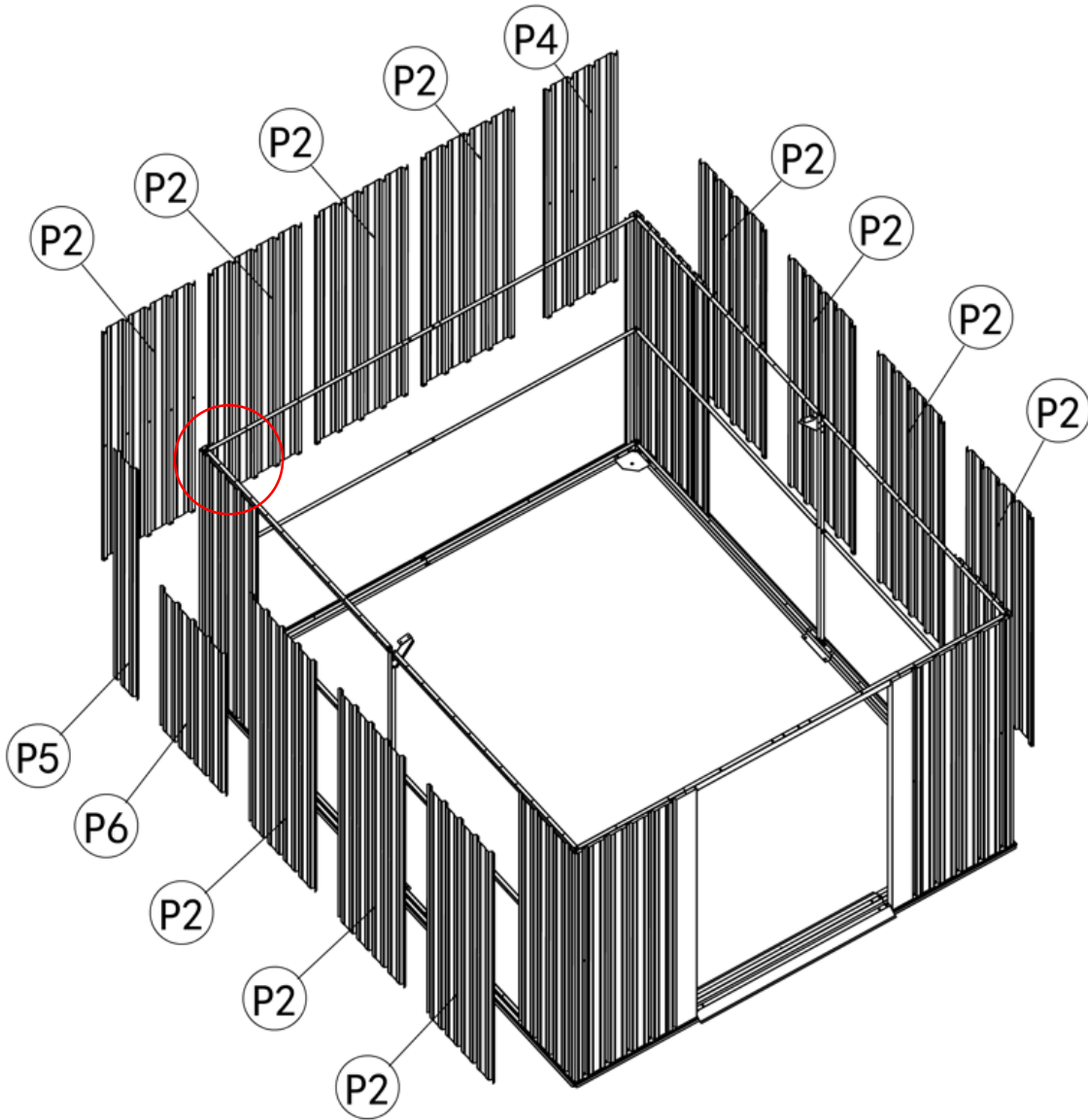
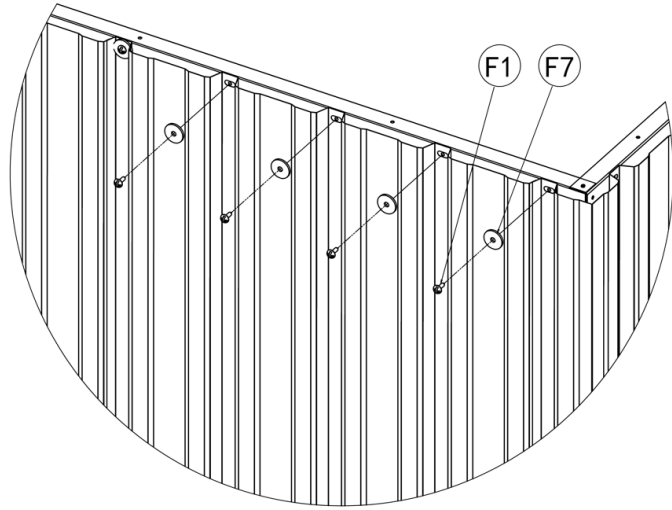

# Window assemble

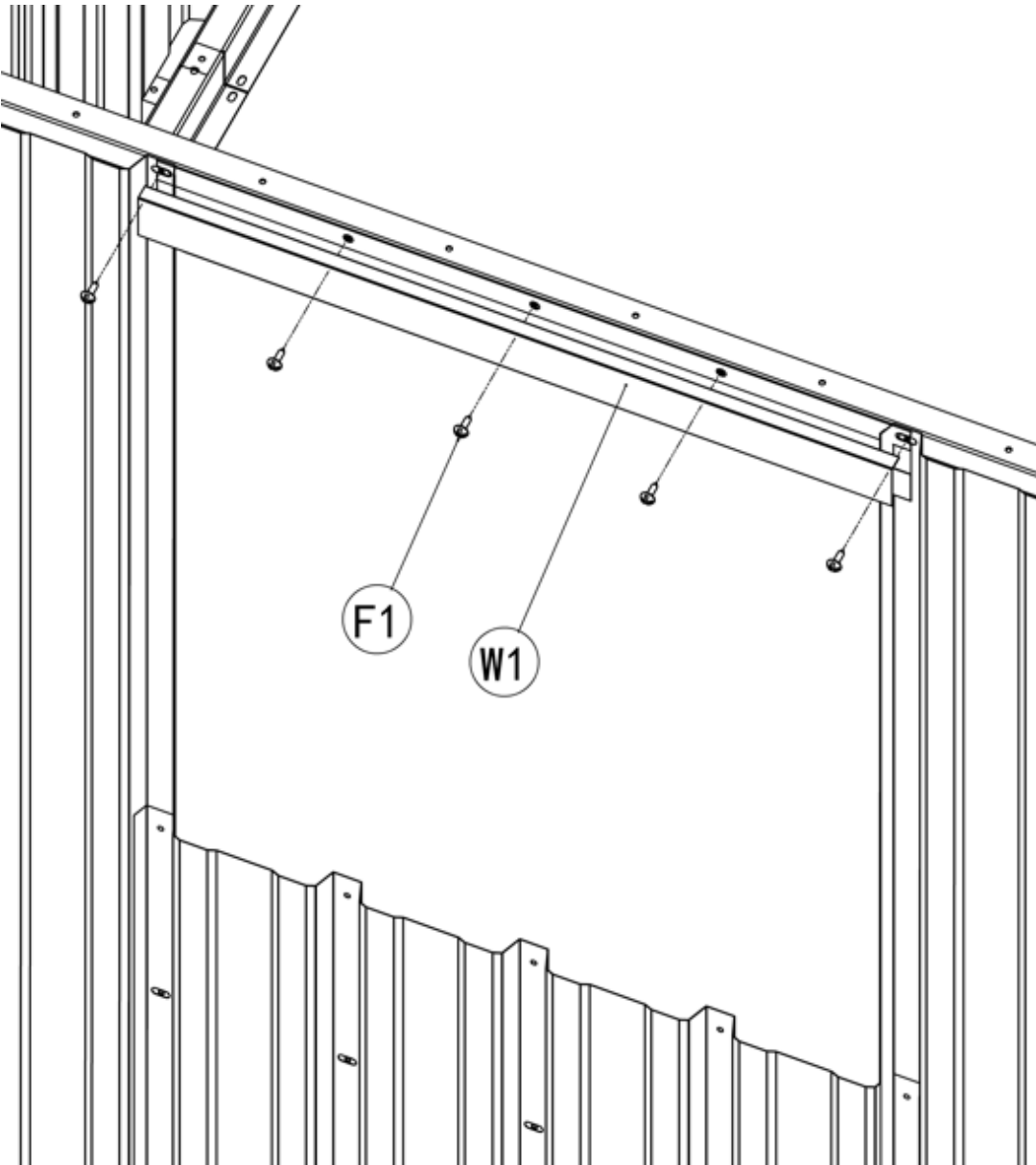

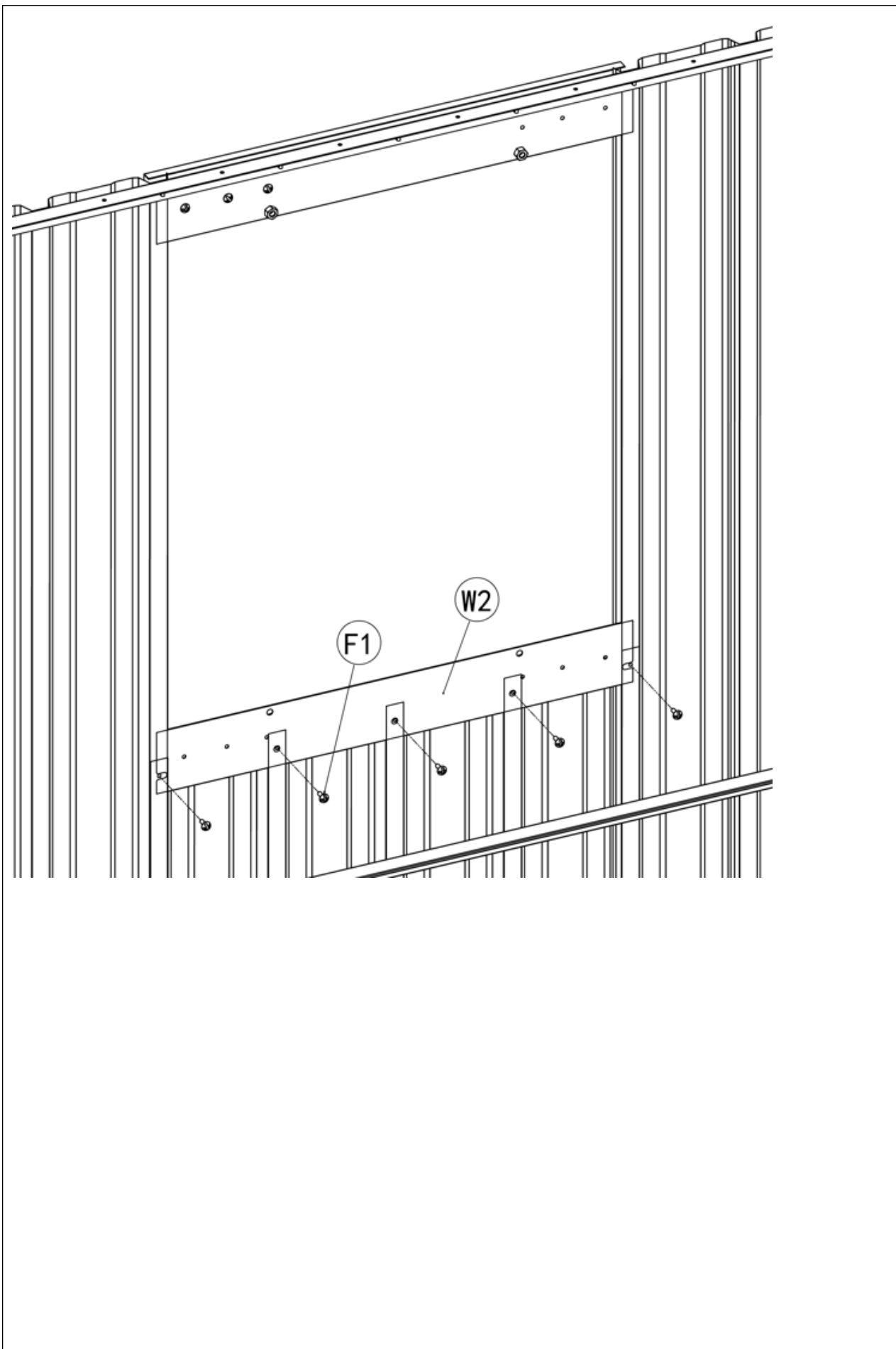

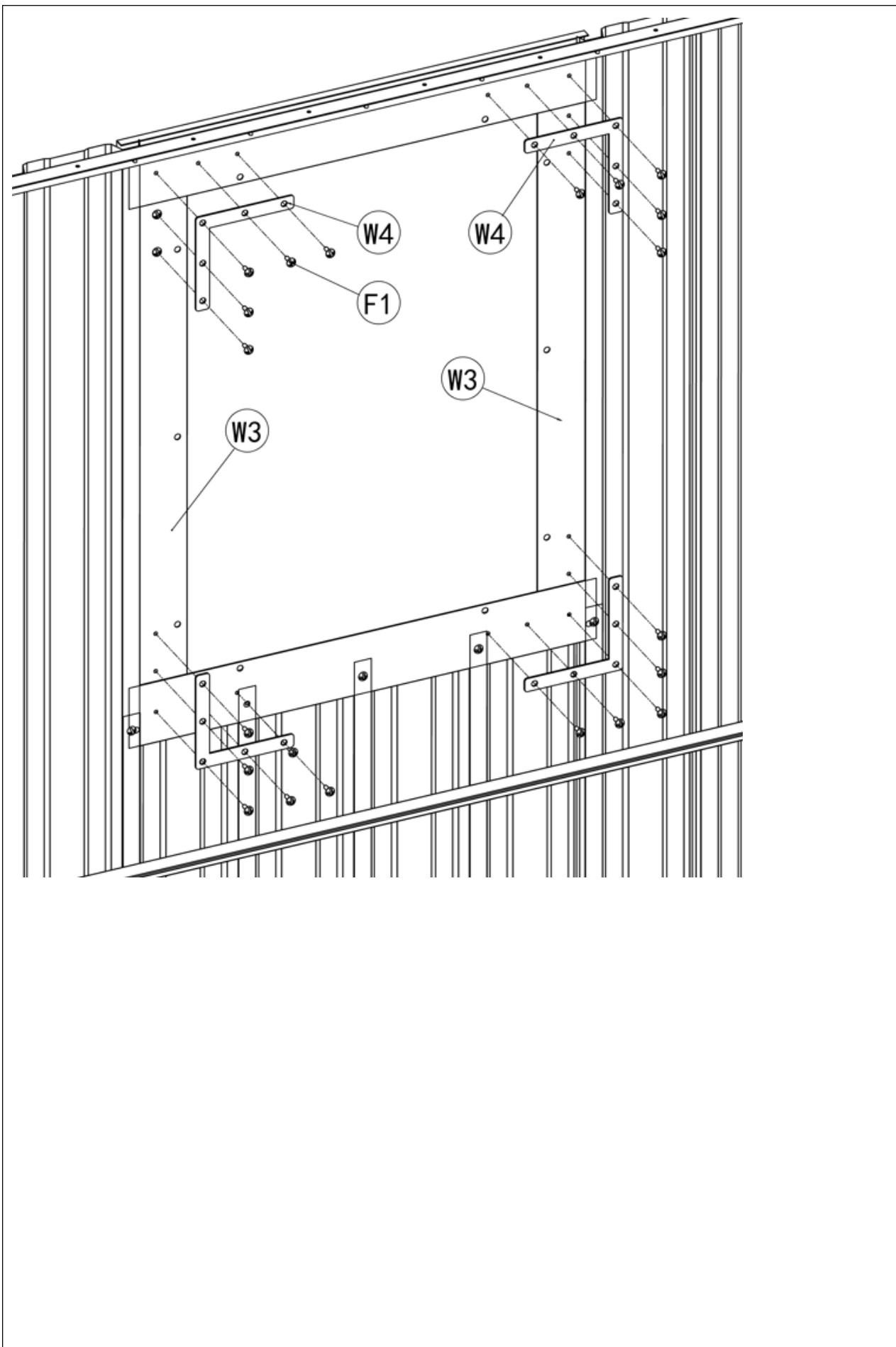

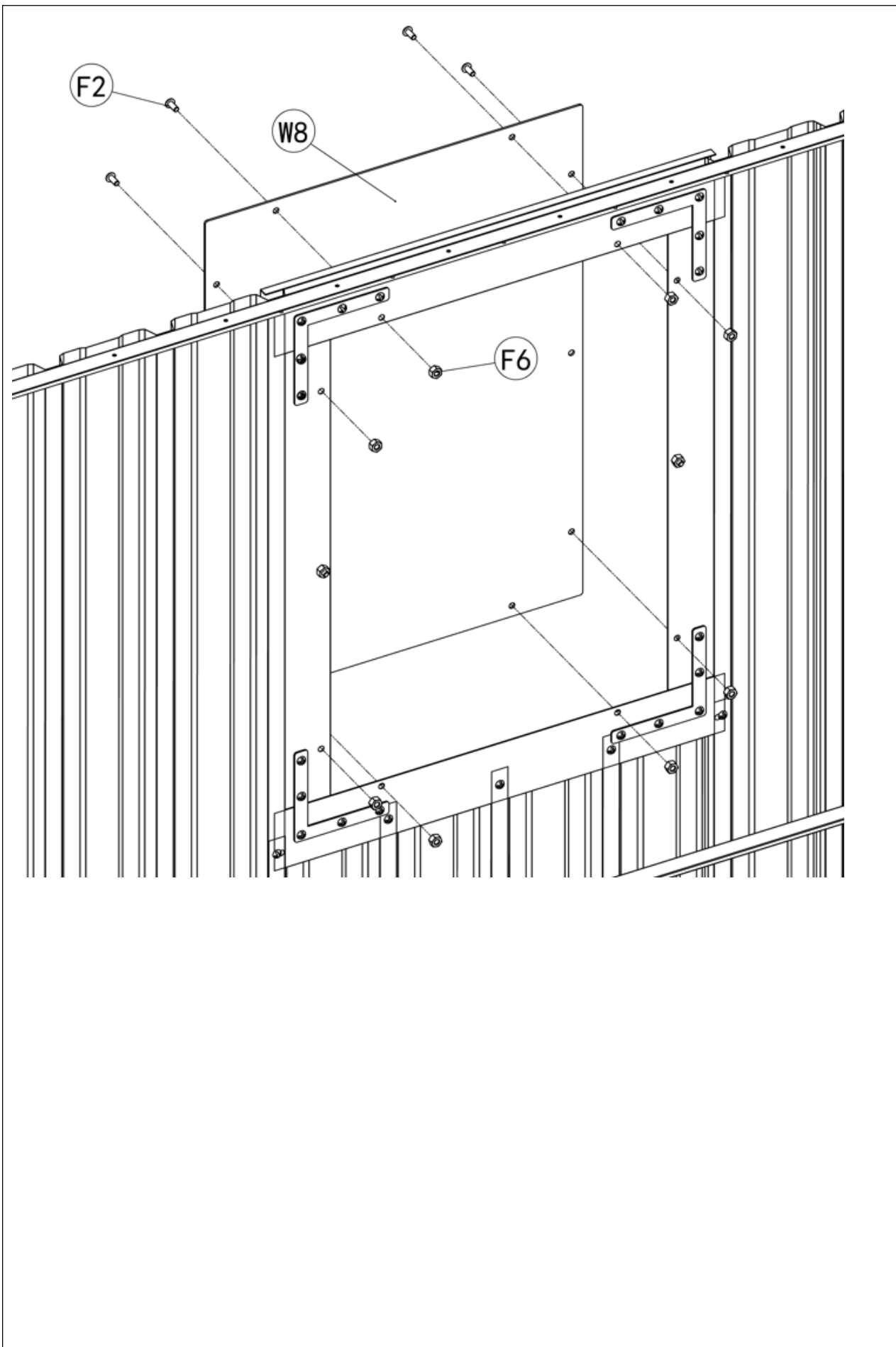

W1

W3





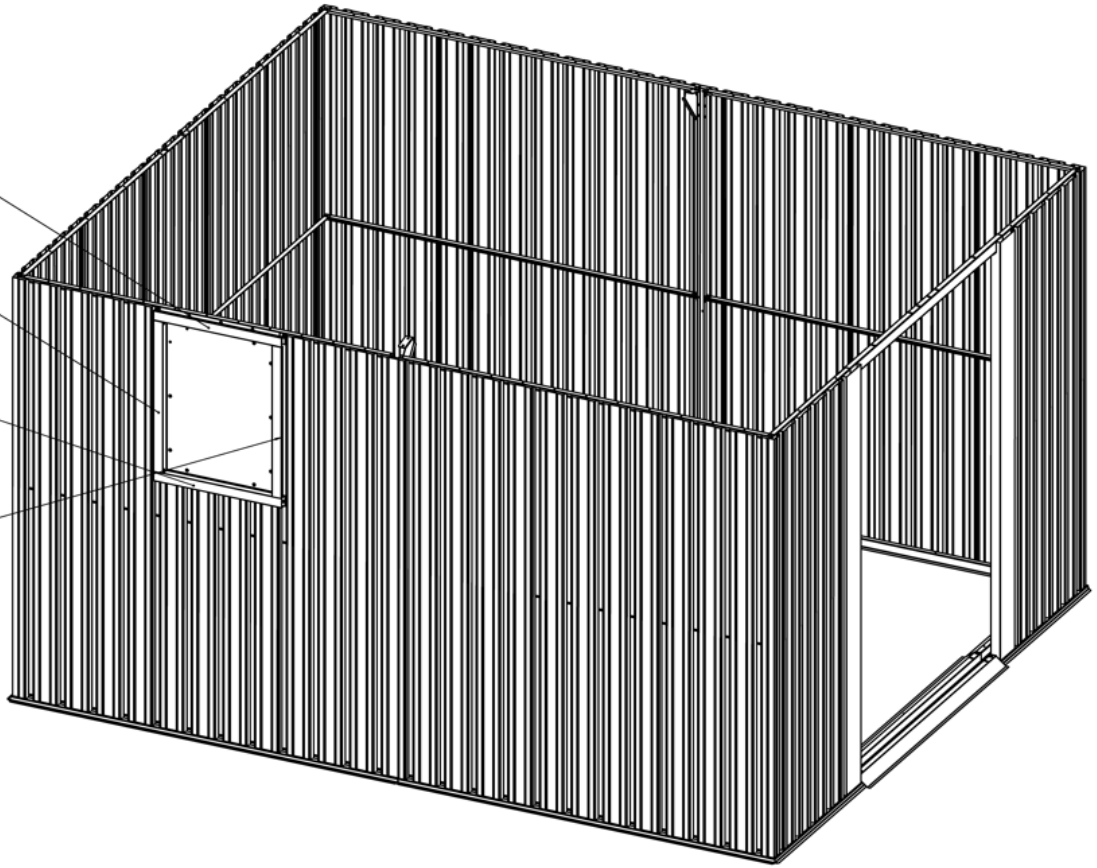















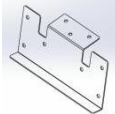

W2

W3



### 3、Roof Assembly

- 1、 Use 2 pcs PL to clamp APR, APL with F2 and F6. Fix C2 to APR with F1. Fix C3 to APL with F1. Fix GF on APR, APL with F4.
- 2、 assembled APR, APL fix on 7,8 with F1.
- 3、 Fix E1, E3, E6 with F2 and F6. Fix E4 to E3, E6 with F2 and F6.
- 4、 Assembled E1, E3, E6 fix on E7 with F2 and F6;
- 5、 Fix ABL, ABR with F2, F7, then fix to APL, APR with screws F2, F6. On the other side connect with E3, E6 with F2 and F6.
- 6、 CL fix on C3 with F2 and F6, on the other side, connect on E4 with F2 and F6. Fix CR on C2 with F2 and F6, on the other side connect on E4 with F2 and F6.
- 7、 Fix AP2 with F1 and F7. Then insert C4 under middle holes of 4pcs of AP2, fix with F1 and F7.
- 8、 Fasten AP5 into AP2 with F1 and F7.
- 9、 Connect AP5 AP6 with F1. fix AP6 and C4 with F1, RT3 fix on AP6 with F1
- 10、 Fix 2pcs of AP7 on AP2 by F1, connect RC2、 AP6、 AP7 with F1.

Part	No	Qty	Part	No	Qty	Part	No	Qty
	ABL	2		C3	2		GF	4
	ABR	2		CL	2		F7	182
	APR	2		CR	2		F1	246
	APL	2		E1	1		F13	8
	PL	4		E3	1		F2	50
	AP2	14		E4	2		C4	4
	AP5	2		E6	1		RC3	2
	AP6	4		RC2	4		C2	2
	AP7	4		F4	20			
	RT3	2		F6	58			

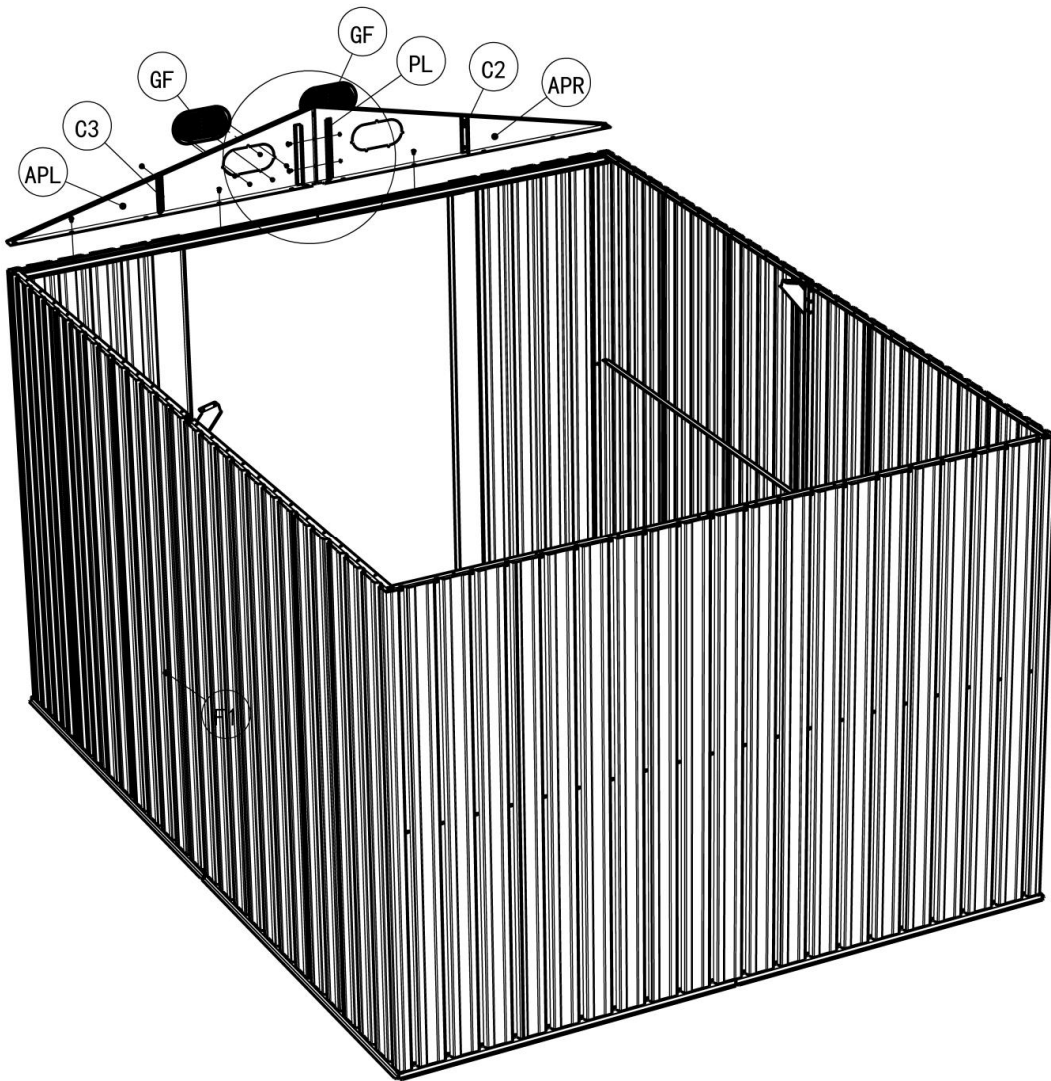
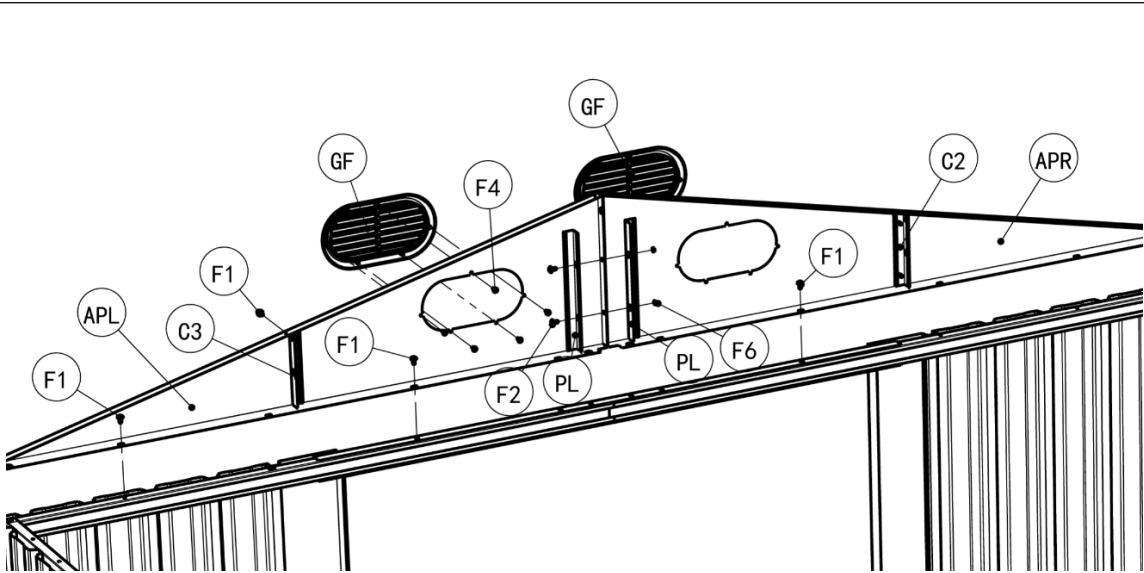

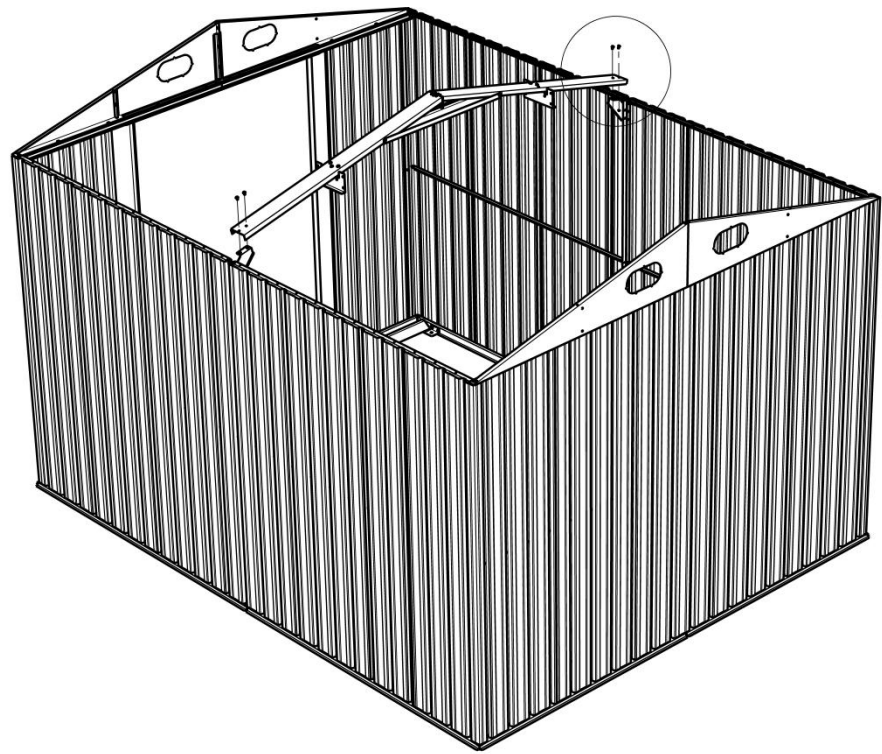
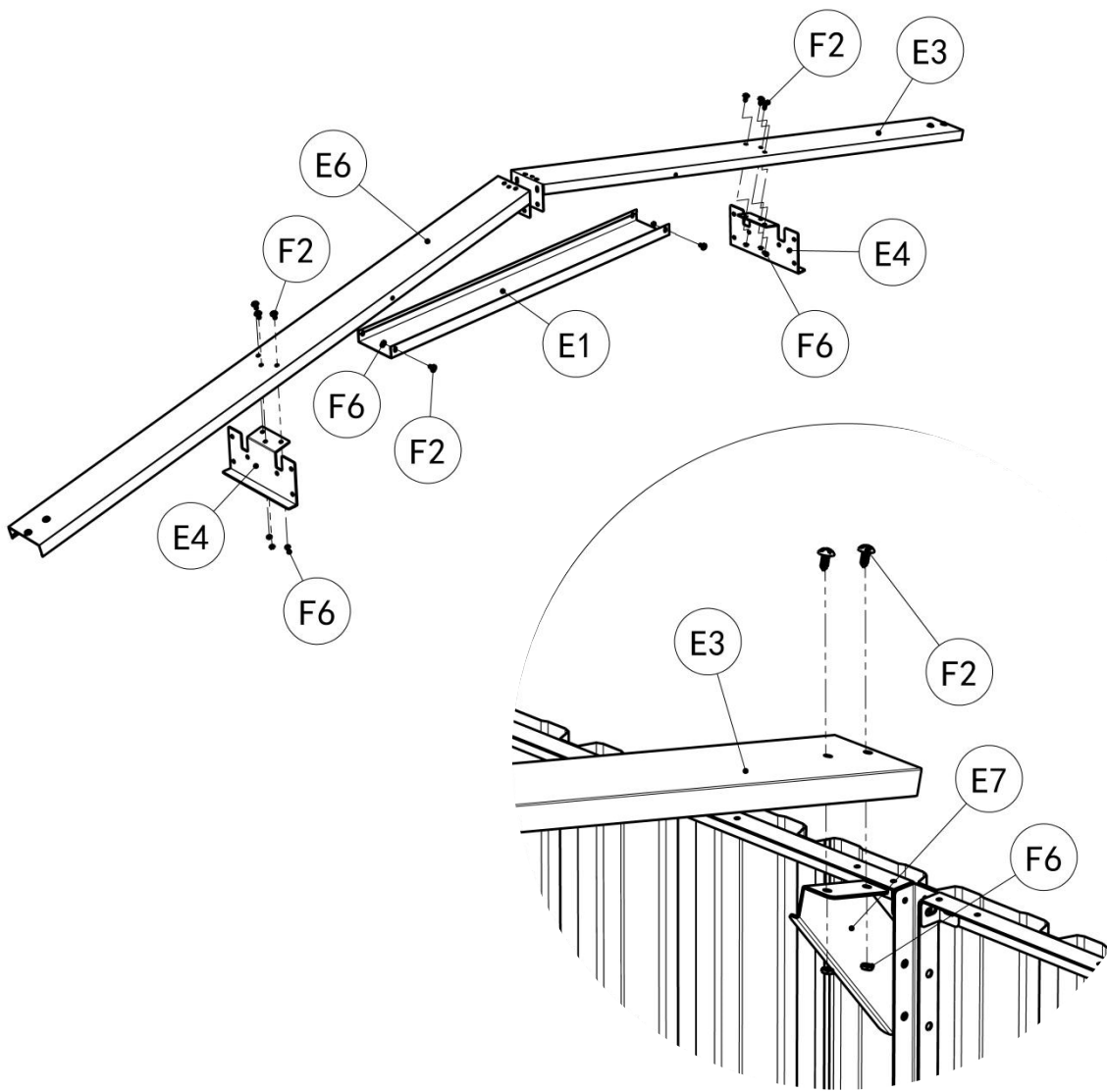

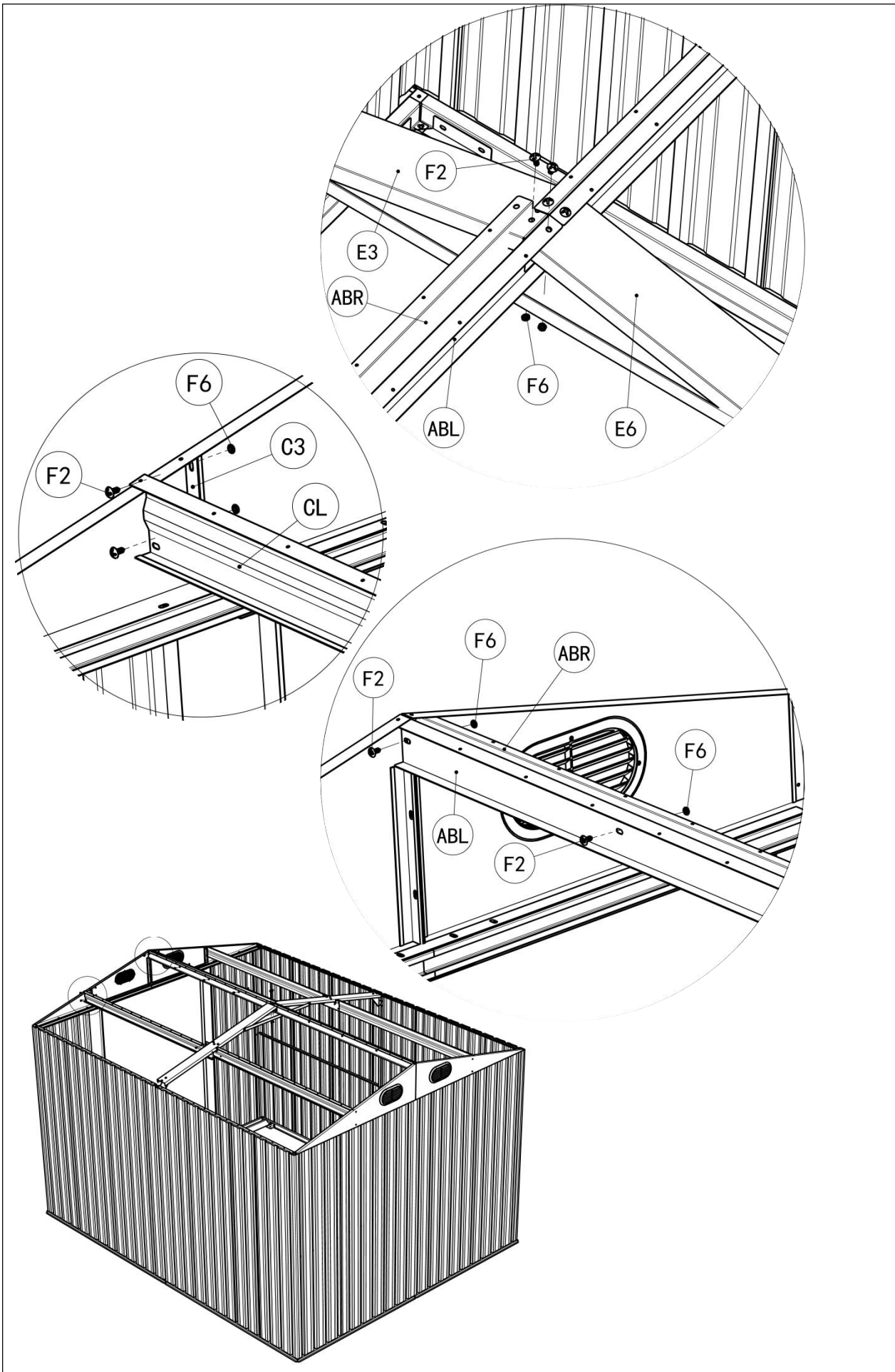

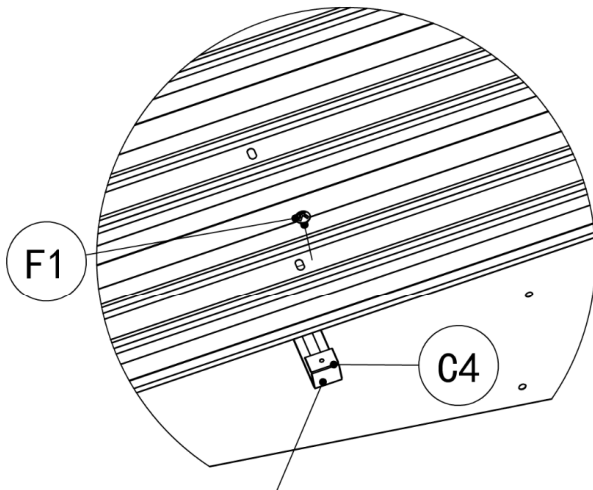

Note: C4 should be inserted under the tile, to align with the first hole and lock with F1

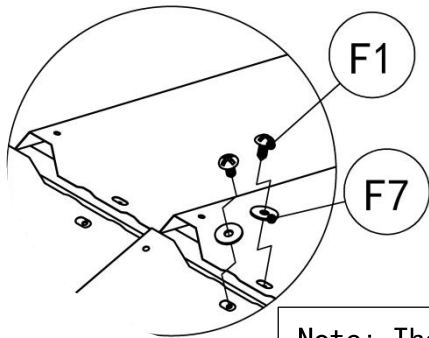

Note: The last two tiles should overlap half piece

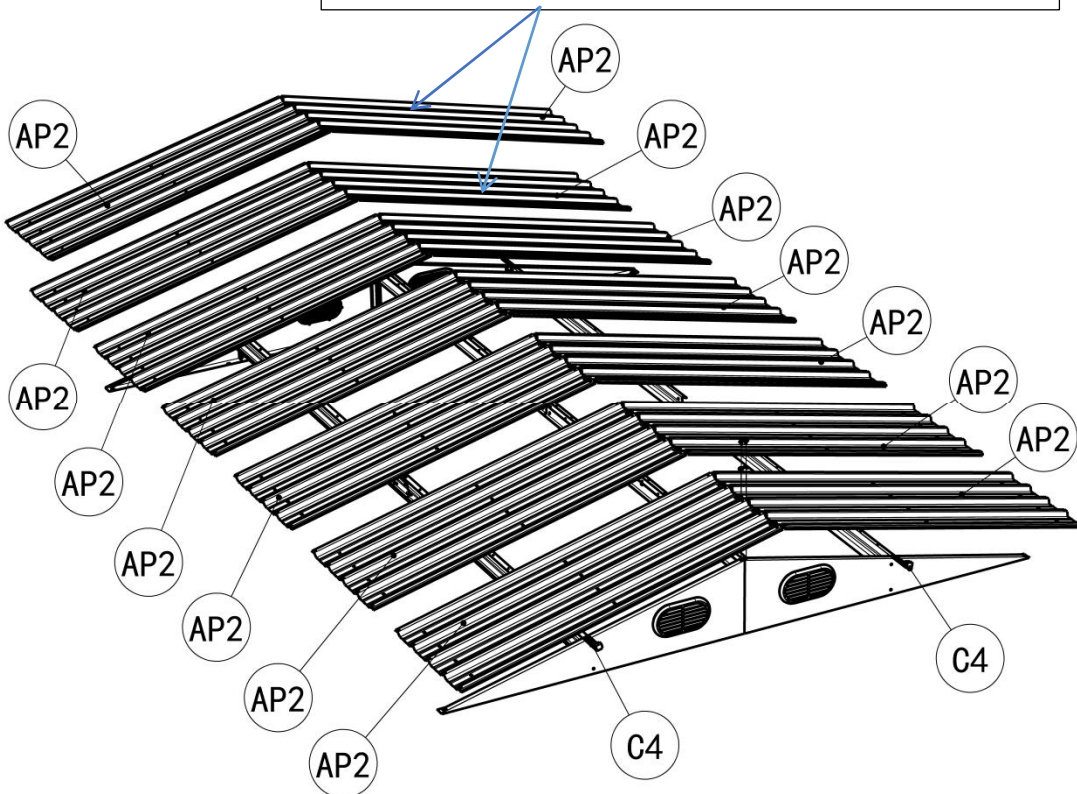

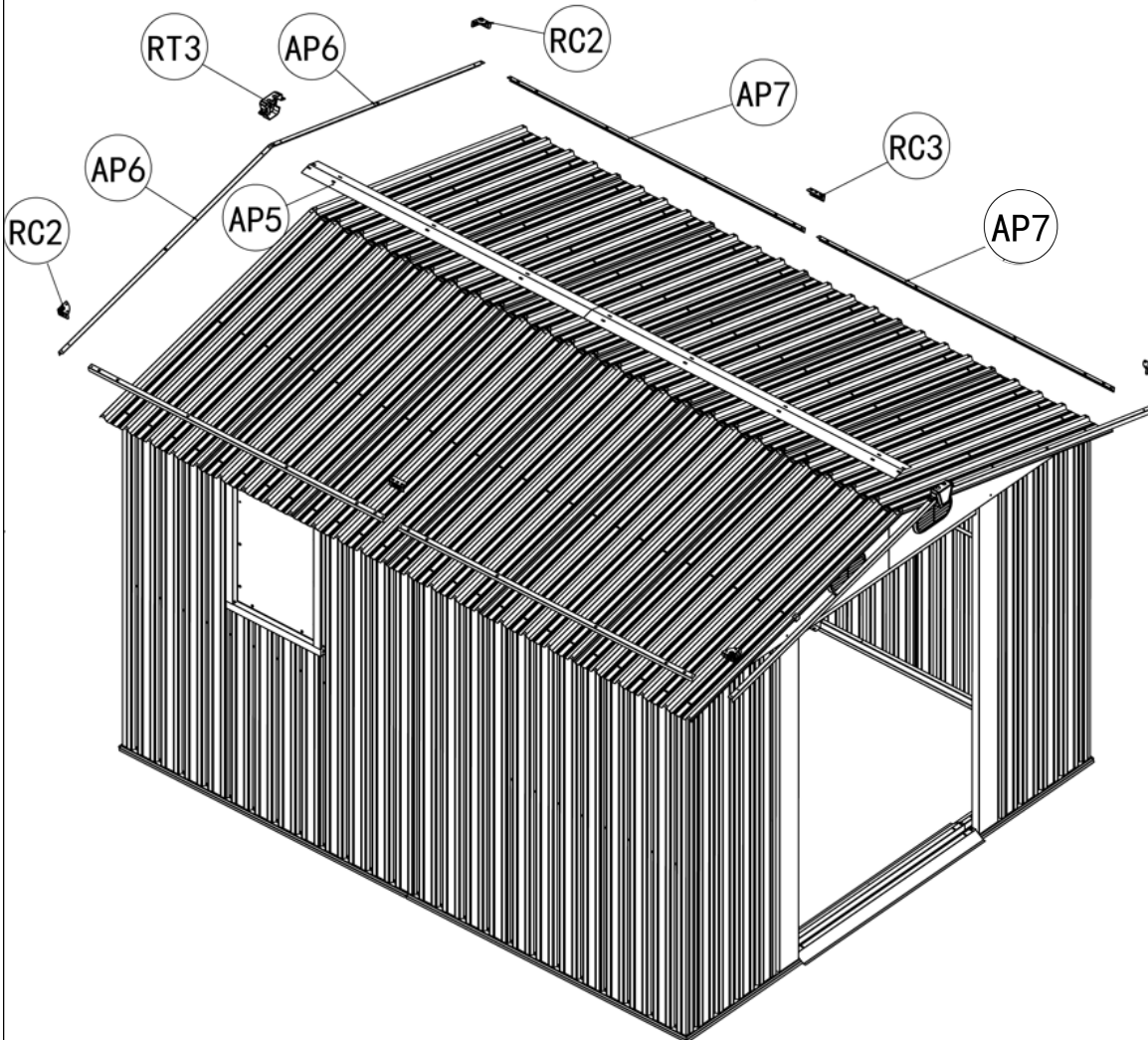
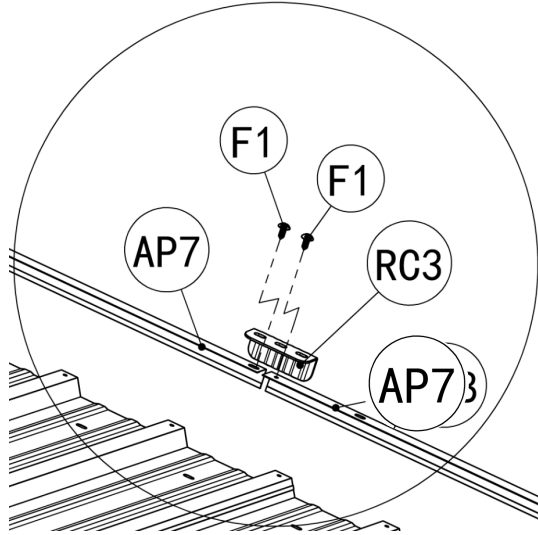
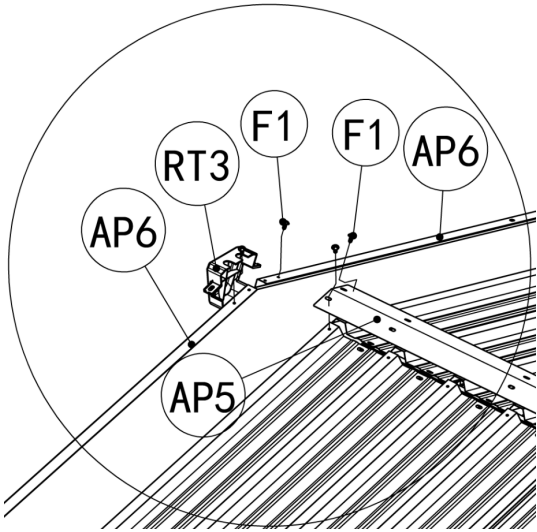







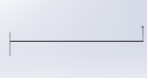

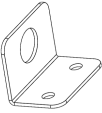

# 4. Door assemble

1. D3, D4, D5, D6, D7, D8 fix on D1, D2 with F2 and F6

D9 fix on D1, D2 with F11, F12

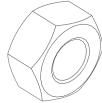
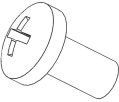
Part	No	Qty	Part	No	Qty	Part	No	Qty
	D1	1		D2	1		D3	4
	D4	2		D5	4		D6	4
	D7	2		D8	4		D9	2
	F2	32		F6	32		F11	4
	F12	4						

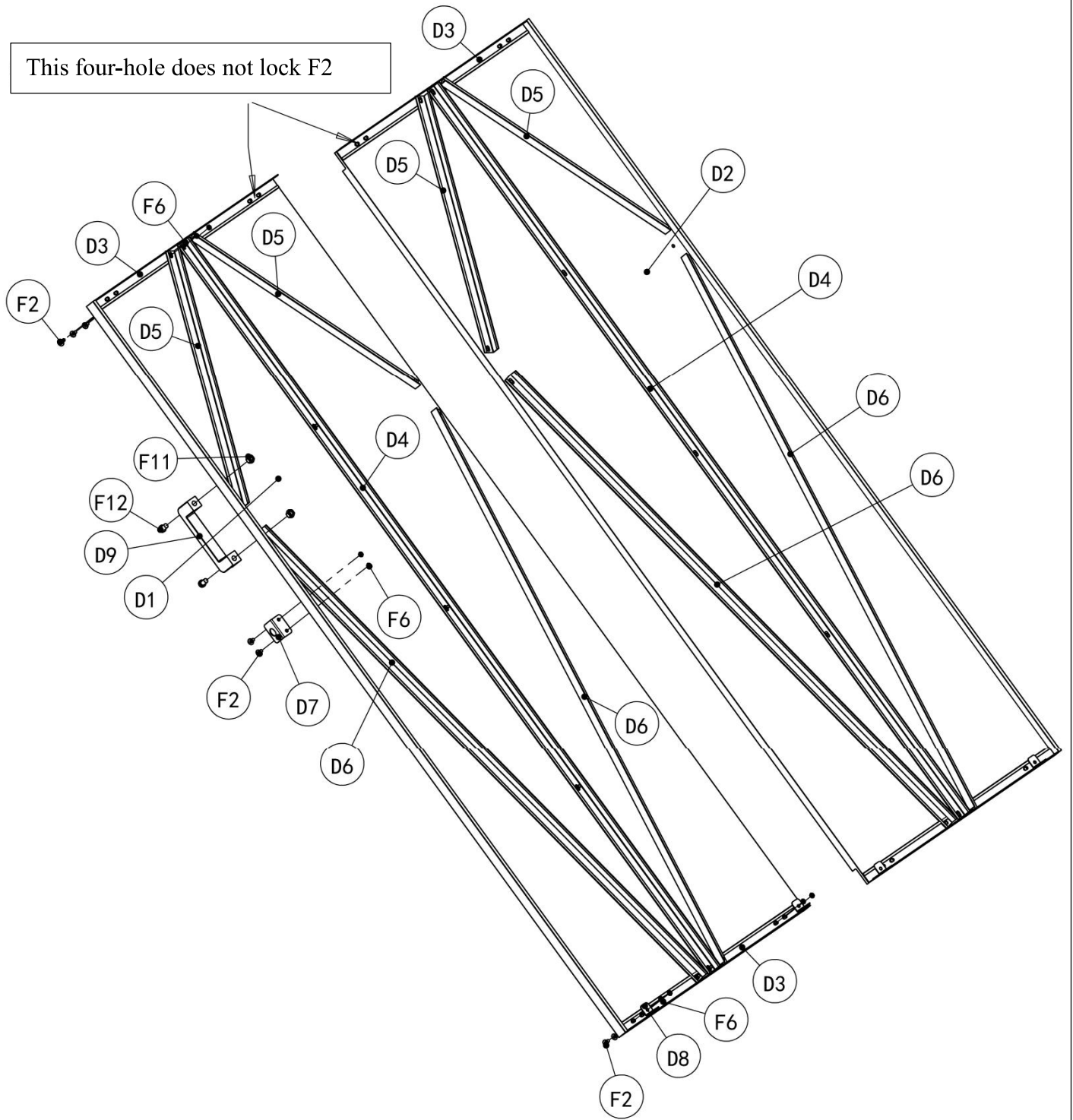

This four-hole does not lock F2



## 5、 Final assembly

1, Put the lower end of the door into slots 2, 3 and 5, and fix it on the installed S1 with F1 (there are three connecting holes on S1 that can be adjusted)

2, F1 set on F8 exposed inside and outside the house

Part	No	Qty
	F1	8
	F8	153

