

ASSEMBLY INSTRUCTIONS  
ROUND TABLE

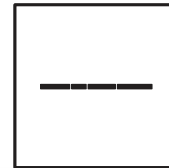

Thank you for purchasing this quality product. Before assembly, please check the packing material carefully for small parts which may have come loose inside the carton during shipping. Please do not discard any packing material until all parts have been located. If any parts are missing, please contact your dealer for prompt replacement.



Caution: (1) These parts are cumbersome and heavy. This product can best be assembled with the assistance of one or more persons in order to prevent personal injury and to ensure parts are not damaged during the assembly process. If dirty, clean finished parts with mild dishwashing liquid and water solution applied on damp cloth. Cloth should not be excessively wet. Polish finish with soft cloth and an industry recognized furniture polish.





(2) To prevent damage to your floor or carpet, please check the bottom of each piece of furniture for stain residue and rough surfaces and also check for staples or nails left after removing the packaging material. The manufacturer will not be held responsible if preventative steps are not taken prior to installation.

(3) During normal use every day, screws, bolts, nuts and wooden plugs may loosen up. They should be periodically inspected and re-tightened to prevent damage to the furniture and (or) personal property or cause injury. Always check to be sure all hardware on this list and the below mentioned components are attached to the furniture properly and kept tightened.

(4) Screw driver needed, to unscrew two components.

Parts & Hardware List:

HARDWARE LIST				QTY'
A		Allen bolt	Ø5/16"x1-1/2"	12
		Lock washer	Ø5/16"x14x2mm	
		Flat washer	Ø5/16"x19x2mm	
B		Allen bolt	Ø5/16"x2-1/2"	12
		Lock washer	Ø5/16"x14x2mm	
		Flat washer	Ø5/16"x19x2mm	
C		Allen key	5mm	1

PART LIST			QTY'
1	TABLE TOP		1
2	CONNECTION BOARD		1
3	LEG		4
4	CONNECTION POST		1
5	TABLE BASE		1

Assembly Procedures:

\*\*NOTE: First read the table leveling instructions. This is an additional assembly sheet found inside the carton. Place all table parts on a clean, cushioned area to prevent scratching the furniture. Make sure the feet are free of stain, staples, screws and nails.

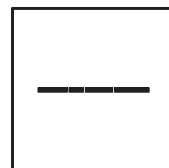

**STEP 1** Put the table top face down on a soft surface, unscrew the bolts and remove the connection board (2) from the top.

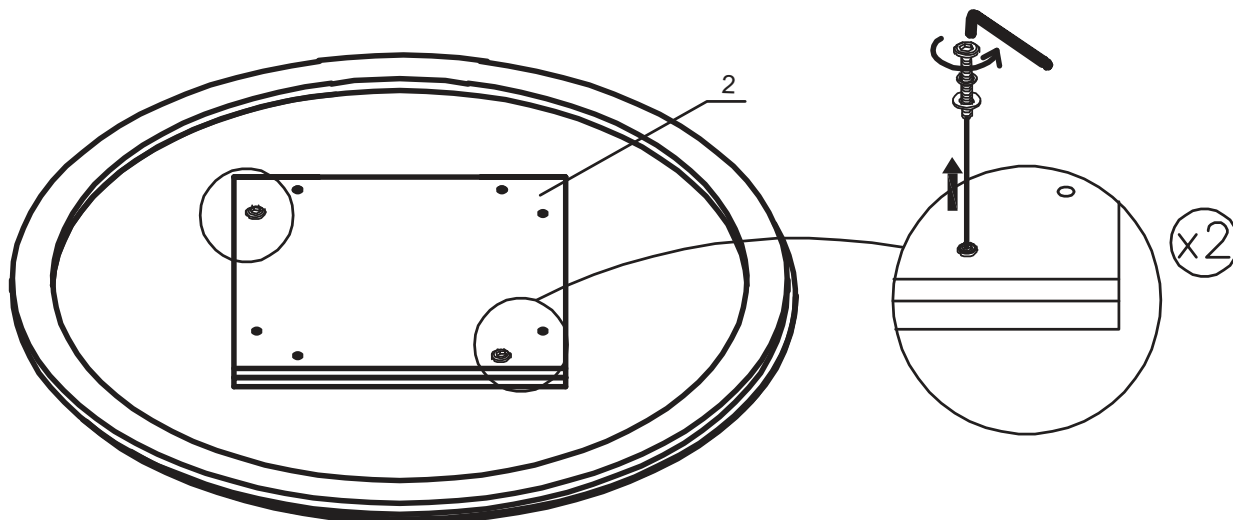

**STEP 2** Connect the four legs (3) to the component (4) with hardware B. Do not tighten them too much for now.

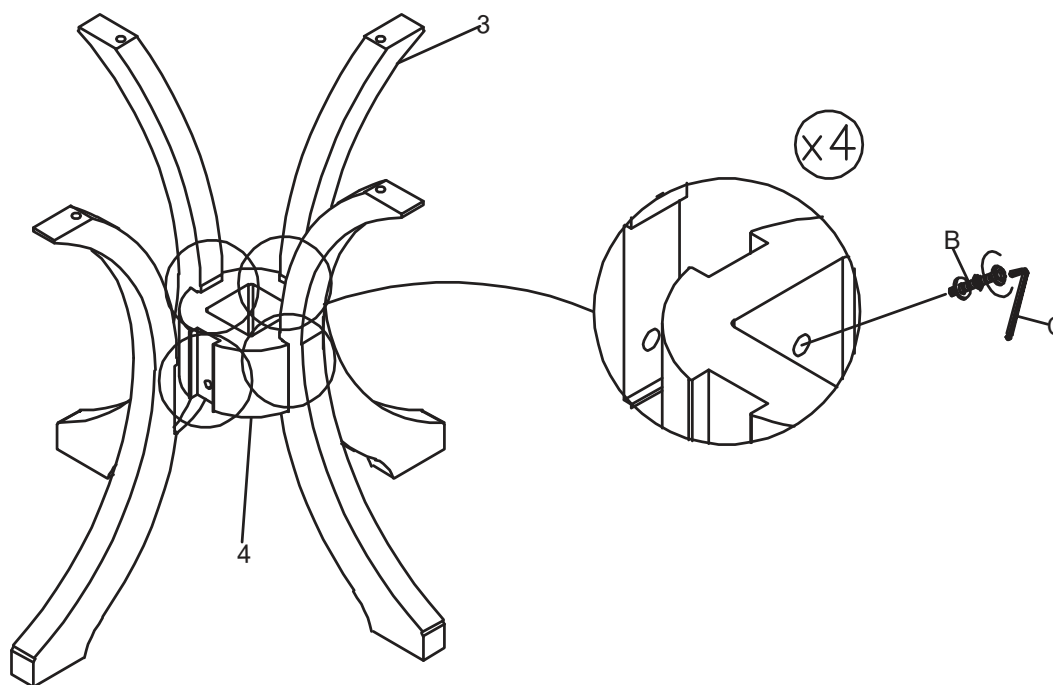

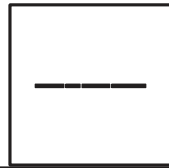

**STEP 3** Attach four legs to connection board (2) by hardware A and tighten.

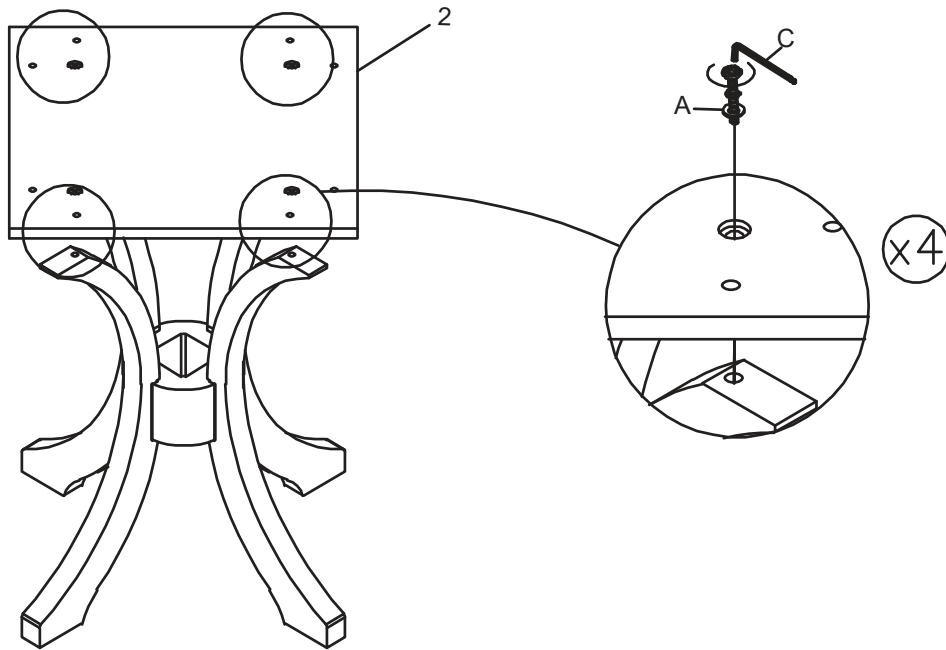

**STEP 4** Put the table top face down on a soft surface, attach connector board (2) and legs to table, see sketch below. Then tighten all bolts.

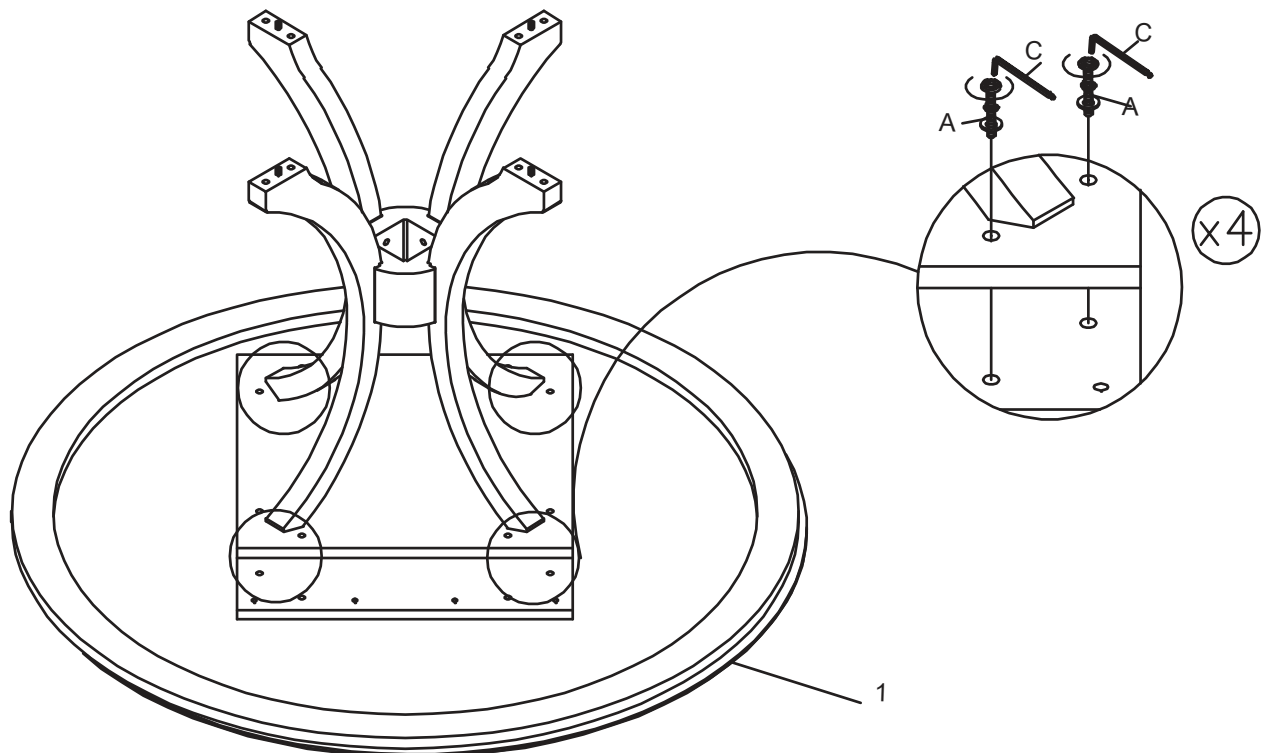

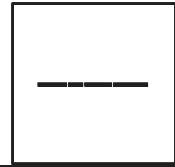

**STEP 5**

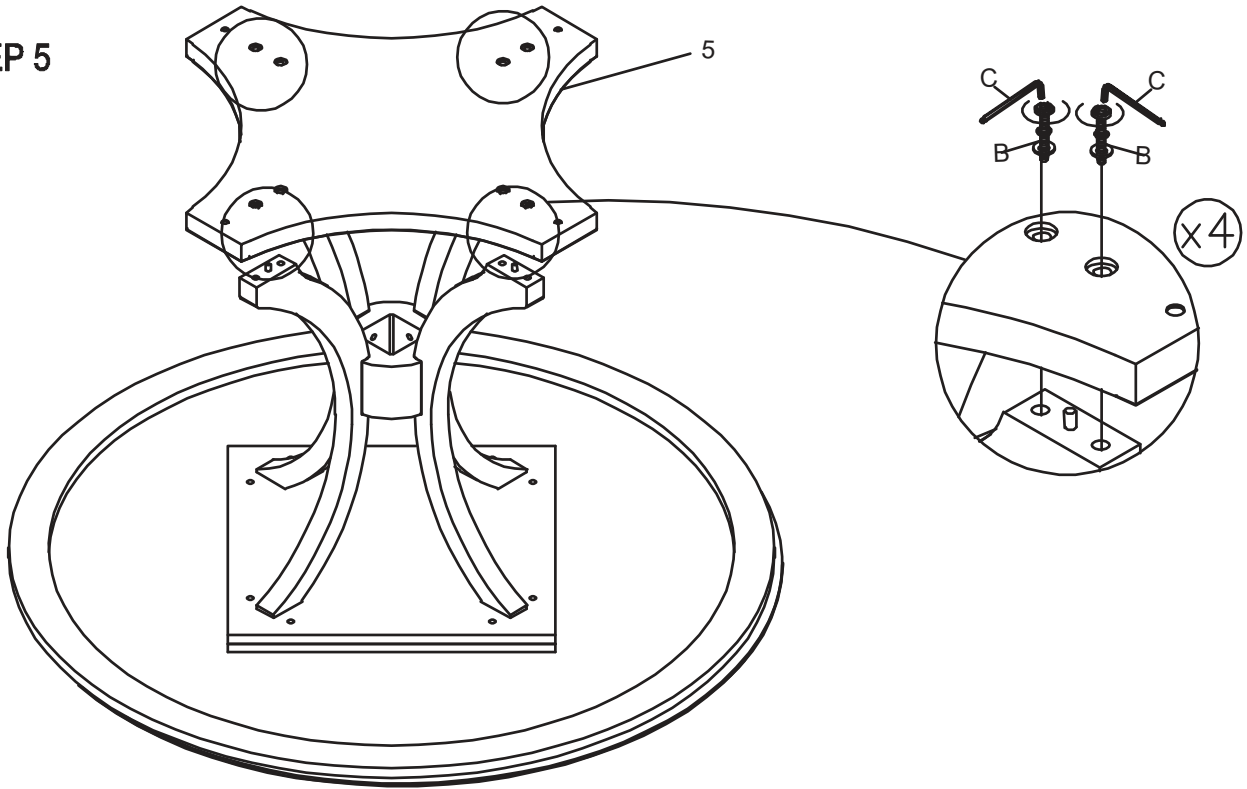

**STEP 6** At the last, you can use the levelers to level the entire table.

