

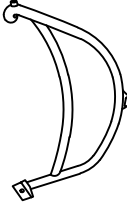







## 46" Cast Aluminm Dining Table



# PARTS LIST

<div style="border: 1px solid black; padding: 2px; width: 20px; float: left; margin-bottom: 5px;">A</div> 	<div style="border: 1px solid black; padding: 2px; width: 20px; float: left; margin-bottom: 5px;">B</div> 	<div style="border: 1px solid black; padding: 2px; width: 20px; float: left; margin-bottom: 5px;">C</div> 
<p style="text-align: center;">Top Panel 1 PC</p>	<p style="text-align: center;">Leg 4 PCS</p>	<p style="text-align: center;">Stretcher 1 PC</p>

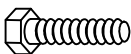
# HARDWARE LIST

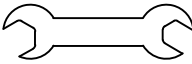
<div style="border: 1px solid black; padding: 2px; width: 20px; float: left; margin-bottom: 5px;">#1</div>  <p style="text-align: center;">M8*25</p>	<div style="border: 1px solid black; padding: 2px; width: 20px; float: left; margin-bottom: 5px;">#2</div>  <p style="text-align: center;">M8</p>	<div style="border: 1px solid black; padding: 2px; width: 20px; float: left; margin-bottom: 5px;">#3</div>  <p style="text-align: center;">M8</p>	<div style="border: 1px solid black; padding: 2px; width: 20px; float: left; margin-bottom: 5px;">#4</div>  <p style="text-align: center;">M8</p>	<div style="border: 1px solid black; padding: 2px; width: 20px; float: left; margin-bottom: 5px;">#5</div>  <p style="text-align: center;">M8</p>
<p style="text-align: center;">Headless Bolt (Extra 1) 4 PCS</p>	<p style="text-align: center;">Spring Washer (Extra 1) 4 PCS</p>	<p style="text-align: center;">Flat Washer (Extra 1) 4 PCS</p>	<p style="text-align: center;">Hex Nut (Extra 1) 4 PCS</p>	<p style="text-align: center;">Nut Cap (Extra 1) 4 PCS</p>
<div style="border: 1px solid black; padding: 2px; width: 20px; float: left; margin-bottom: 5px;">#6</div>  <p style="text-align: center;">M6*30</p>	<div style="border: 1px solid black; padding: 2px; width: 20px; float: left; margin-bottom: 5px;">#7</div>  <p style="text-align: center;">M6</p>	<div style="border: 1px solid black; padding: 2px; width: 20px; float: left; margin-bottom: 5px;">#8</div>  <p style="text-align: center;">M6</p>	<div style="border: 1px solid black; padding: 2px; width: 20px; float: left; margin-bottom: 5px;">#9</div> 	
<p style="text-align: center;">Bolt (Extra 1) 8 PCS</p>	<p style="text-align: center;">Small Flat Washer (Extra 1) 8 PCS</p>	<p style="text-align: center;">Bolt Cap (Extra 1) 8 PCS</p>	<p style="text-align: center;">Wrench 1 PC</p>	

## ADDITIONAL TOOLS (Not Provided)

Note: It is not recommended to use power tools during assembly.



Flathead Screwdriver

Step 1. Carefully turn top panel (part A) upside down on a soft flat surface, such as carpet, as shown below. Attach headless bolts (part #1) to top panel (part A) using flathead screwdriver.

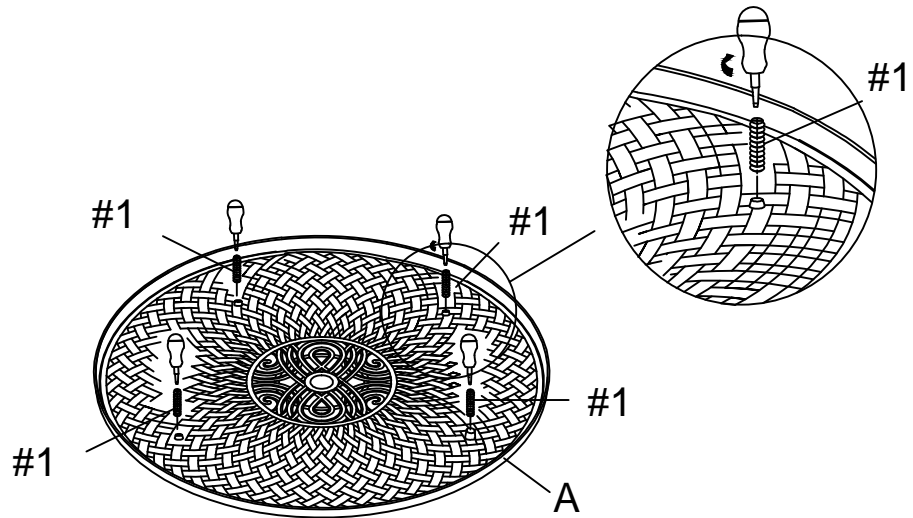



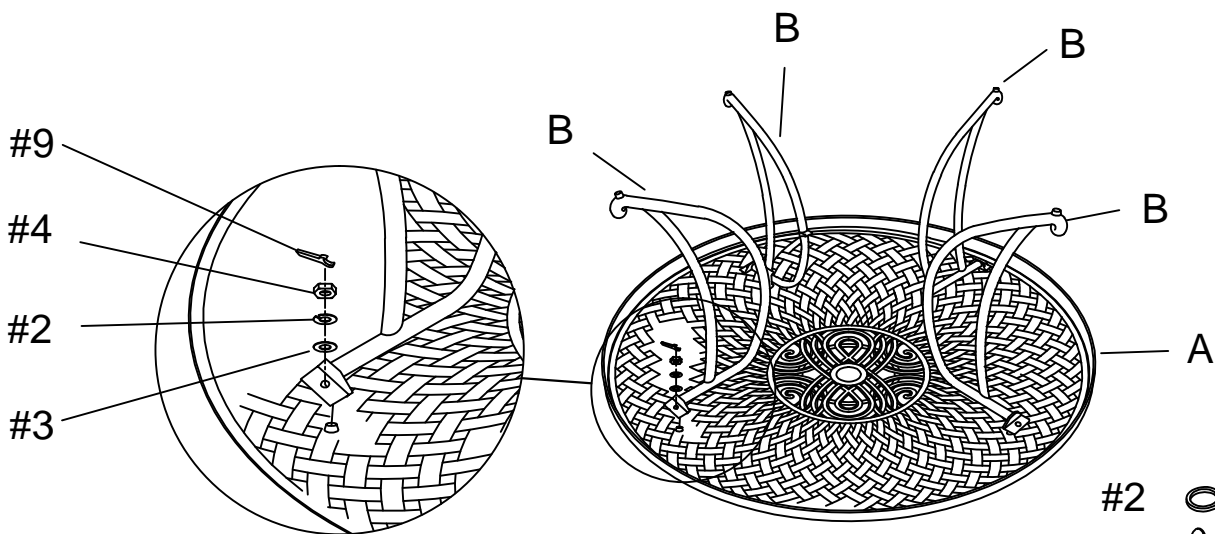

#1  x 4

Step 2. Attach legs (part B) to top panel (part A) using installed headless bolts (part #1), flat washers (part #3), spring washers (part #2), hex nuts (part #4) and wrench (part #9).

NOTE: Please do not fully tighten hex nuts until unit is fully assembled.





#2  x 4  
 #3  x 4  
 #4  x 4  
 #9  x 1

Steps 3. Attach stretcher (part C) to installed legs (part B) using bolts (part #6), small flat washers (part #7) and wrench (part #9).

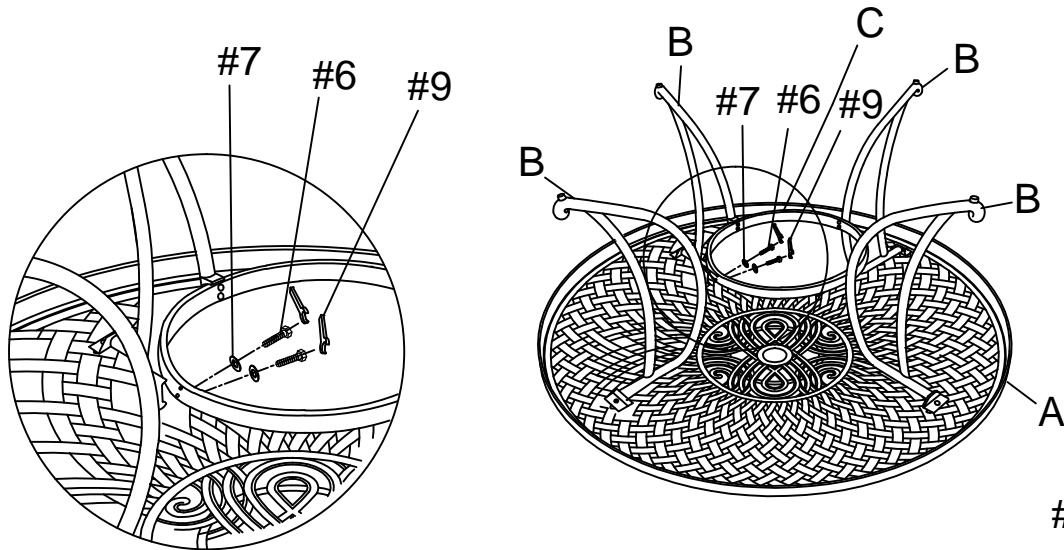
NOTE: Please fully tighten all hex nuts at this time.





- #6  x 8
- #7  x 8
- #9  x 1

Step 4. Cover hex nuts (part #4) and bolts (part #6) using nut caps (part #5) and bolt caps (part #8). Carefully turn unit upright.

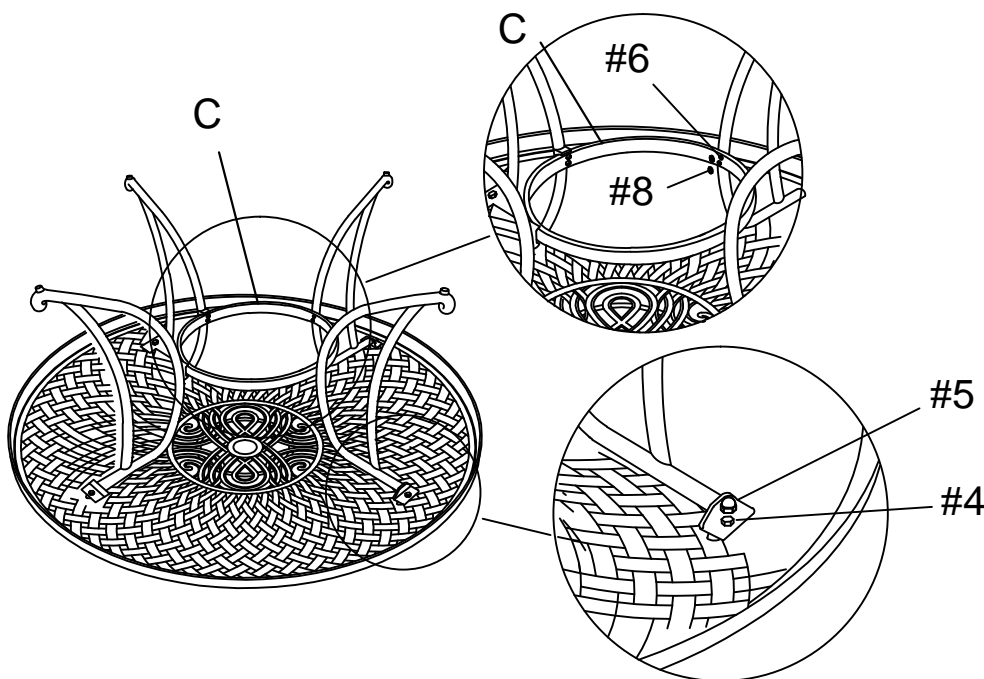
NOTE: It is important to adjust levelers once fully assembled and upright. Extend adjustable leveler until it's firmly in contact with the floor. If relocating, adjust leveler as needed until it's firmly in contact with the floor in new location.



- #5  x 4
- #8  x 8