

LORRAINE CONSOLE TABLE





INSTALLATION GUIDE



CAUTION: THE TABLE IS FRAGILE, HEAVY AND UNSTABLE BEFORE THE INSTALLATION. ANY FALL DOWN OR HIT MAY DAMAGE THE TABLE.



HARDWARE (INCLUDED)		
WALL ANCHOR (5/16")		3
DRYWALL ANCHOR		3
1 5/8" SCREWS		3

TOOLS (NOT INCLUDED)	
HAND DRILL	
CONCRETE DRILL BIT (5/16")	
PHILLIPS SCREWDRIVER	
LEVEL TOOL	

INSTRUCTIONS

1. PLACE THE TABLE AT THE WALL. LEVEL THE TABLE BY WIDTH AND LENGTH.

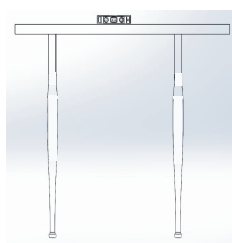

2. MARK THE THREE HOLES ON THE WALL.

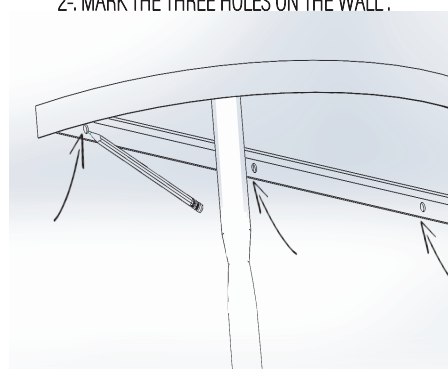

3. DRILL THE MARKS, PLACE THE WALL ANCHOR INTO THE HOLE.

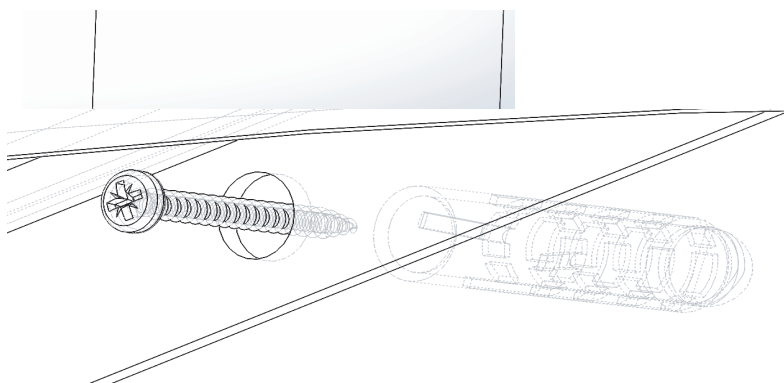

4. PLACE THE TABLE ON THE WALL LINED ALIGNED THE DRILLS WITH TABLE HOLES

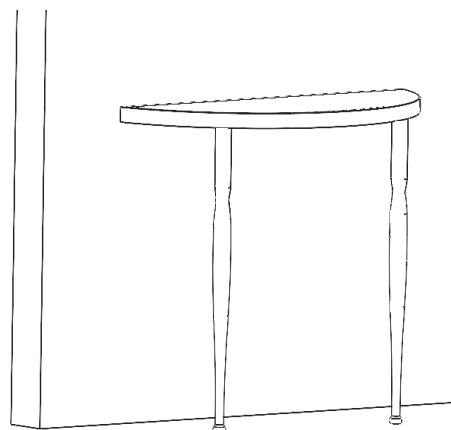

5. TIGHTEN THE SCREWS USING THE SCREWDRIVER.

