

**USER'S MANUAL**

---

**ICE MAKER**

**Read this manual thoroughly before using and save it for future reference**

## **IMPORTANT SAFETY INSTRUCTIONS**

**To reduce the risk of fire, explosion, electric shock, or injury when using your ice maker, follow these important safety instructions:**

1. Before using check that the voltage power corresponds to the one shown on the appliance nameplate.
2. Do not remove any safety, warning, or product information labels from your ice maker.
3. Plug the ice maker into an exclusive grounded outlet. No other appliance should be plugged into the same outlet. Be sure that the plug is fully inserted into the receptacle.
4. This appliance must be grounded. It is equipped with a cord having a grounding plug. The plug must be plugged into an outlet that is properly installed and grounded.
5. Avoid the use of an extension cord because it may overheat and cause a risk of fire. However, if it is necessary to use an extension cord:
  - (1) Use only extension cords with grounding plug.
  - (2) The marked rating of an extension cord must be equal to or greater than the rating of this appliance.
  - (3) It should be positioned such that it does not drape over the counter or tabletop where it can be pulled on by children intentionally.
6. Do not operate any appliance with a damaged cord or plug or after the appliance malfunctions or has been damaged in any manner. Return the appliance to the nearest authorized service facility for examination, repair or adjustment.
7. Do not let cord hang over edge of table or counter.
8. Do not place on or near a hot gas or electric burner, or in a heated oven.
9. Place power cord in such a way it cannot be pulled on by children or cause a tripping hazard.

10. Place power cord in such a way that it is not in contact with hot surfaces.
11. The use of attachment not recommended or sold by the manufacturer may cause fire, electric shock or injury.
12. Do not touch the ice-making parts when using the ice maker or making ice to avoid frostbite.
13. Do not immerse any part of the product in water.
14. To disconnect, turn any control to "OFF", then remove plug from wall outlet.
15. Do not plug or unplug product with wet hands.
16. Unplug the product before cleaning, maintaining and when not in use.
17. Do not use with water that is microbiologically unsafe or of unknown quality.
18. Do not clean your ice maker with any flammable fluids. The fumes may create a fire hazard or explosion.
19. Do not overturn the ice maker. If the ice maker is overturned accidentally, make it stand steadily for 2 hours before power it on again.
20. If the ice maker is brought in from outside in wintertime, do not use for a few hours, allowing the unit to warm up to the room temperature before operating.
21. Never put flammable, explosive and corrosive articles into the ice maker.
22. Never use the ice maker when there is flammable gas leakage.
23. Never store or use gas and other flammable articles near the ice maker to avoid any fire.
24. Unplug the ice maker before moving it to avoid damaging the refrigerating system.
25. Do not attempt to disassemble, repair, modify, or replace any part of your product.

26. This appliance is not intended for use by persons (including children) with reduced physical, sensory or mental capabilities, or lack of experience and knowledge, unless they have been given supervision or instruction concerning use of the appliance by a person responsible for their safety.

27. Children should be supervised to ensure that they do not play with the appliance.

28. Close supervision is necessary when any appliance is used by or near children.

29. Do not leave the appliance unattended while in use.

30. Do not use outdoors.

31. Do not use the appliance for other than intended use.

32. Please dispose of the ice maker according to local regulations as it uses flammable blowing gas and refrigerant.





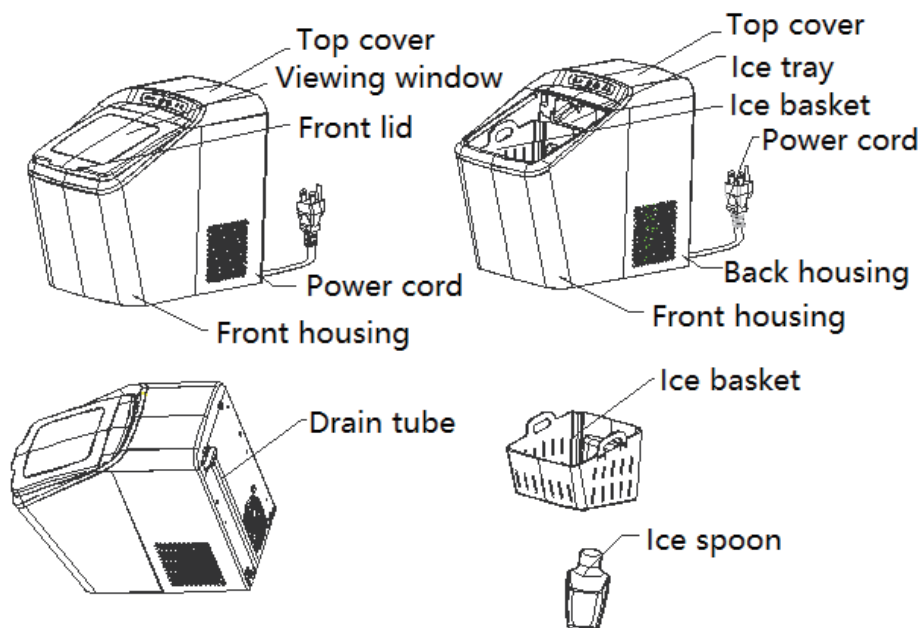

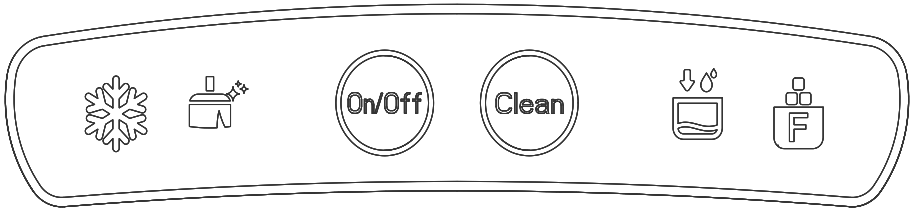

## SAVE THESE INSTRUCTIONS HOUSEHOLD USE ONLY

### KNOW YOUR ICE MAKER



## CONTROL PANEL



Key/Indicator	Function
	Start or stop the appliance.
	“Clean” key.
 lights solidly	The “Ice-making” indicator will light solidly when the appliance is making ice.
 lights solidly	The “Clean” indicator will light solidly when the appliance is performing cleaning.
 flashes	Water refill indication. The “No water” indicator will flash when the appliance needs to be refilled. The appliance will be refilled with water automatically if it is of water-refill function.
 lights solidly	The “Ice full” indicator will light solidly when the ice basket is full.
 lights solidly, and  flashes	Defrosting indication. The appliance is defrosting.

## BEFORE FIRST USE

1. Unpack the appliance, then check and make sure that all the accessories including ice basket and ice scoop etc. are complete. Please contact our customer service if some accessories are missed.
2. Please ensure the ice maker is level and on a stable table or platform to avoid malfunction.
3. The incline angle of the ice maker cabinet should not exceed 45° during transportation or use. Do not turn the ice maker upside down. Doing so could cause the compressor or refrigerating system to operate incorrectly. Please allow time for the fluids in the compressor to settle after the ice maker is moved or transported. Before using the ice maker for the first time, please wait for 2 hours after the unit has been leveled and positioned in the proper place.
4. The appliance must be placed on a dry and level surface with sufficient ventilation, far from heat sources such as ovens, heaters and corrosive gases. Leave a 5.91”(15 cm) clearance on all sides of the ice maker for proper ventilation.
5. Do not fill the water reservoir with hot water. This may damage the ice maker. It is best to fill the water reservoir with water of room temperature or lower.
6. Do not use the appliance at a very cold environment (lower than 41 °F).
7. Clean the appliance by following the operation of **“CLEANING AND MAINTENANCE”** before operating.

## USING YOUR ICE MAKER

1.Ensure that the drain plug at the back of ice maker is closed well.

2.Plug the ice maker into the wall outlet, the “” indicator flashes.

**NOTE:** Please make the ice maker rest for 30 minutes before plugging in if it has been moved.

3.Open the front lid and remove the ice basket.

4.Fill the water reservoir with drinking water.

**NOTE:** Do not fill above the MAX water level mark.

5.Replace the ice basket and close the front lid.

6.Press the “ON/OFF” key and the “” indicator lights solidly.

7.The ice-making cycle will last approximately 20-30 minutes, depending on the ambient temperature and water temperature.

8.The ice-making assembly is equipped inside of appliance, and the ice-making assembly will keep producing ice when the water is pumped into it. When the ice forms in the ice-making assembly, the ice cubes will be transferred into the ice tray and then the ice cubes will drop into the ice basket. And the above action will be repeated until the ice basket is full.

9.The “” indicator will light up when the ice basket is full and then the ice maker will stop the ice-making cycle automatically. Open the front lid and gently remove the ice from the ice basket with the ice scoop. And then replace the ice basket and close the front lid, then the ice maker will restart its ice-making function automatically. If the ice is not removed, after about 8 hours, the appliance will automatically work again, alternatively, you can press “ON/OFF” key to restart the appliance.

10.The “” indicator will flash when the water reservoir is lack of water.

(1)If the appliance is connected with external water source by the 1/4PE tube shown in the section of “CLEANING AND MAINTENANCE” (see Fig.1), the water reservoir will be refilled with water automatically and the appliance will restart the

ice-making cycle; alternatively, the user can remove the ice basket and refill the water reservoir with water to “MAX” mark manually, and then the appliance will restart the ice-making cycle automatically. Please remember to close the front lid after refilling water manually to avoid overflow.

(2) If the appliance is not connected with external water source, firstly remove the ice basket and then fill the water reservoir with water manually. After the water reservoir is refilled with water, please close the front lid, then the appliance will restart the ice-making cycle automatically.

11. When you have got your desired amount of ice, stop the ice-making cycle by pressing the “ON/OFF” key and unplug the unit from the wall outlet.

12. Open the front lid and transfer the ice to a freezer.

13. Allow the ice maker to reach room temperature.

14. Suggest replacing the water every a week. Please empty the water reservoir if the ice maker is not used for a long time.

15. The ice maker can be connected with external water source by the 1/4PE tube shown in the section of “CLEANING AND MAINTENANCE” (see Fig.1) if you want to add the function of refilling water automatically.

## **CLEANING AND MAINTENANCE**

To keep your ice tasting fresh and your ice maker looking great, we recommend cleaning your ice maker at least once per week.

1. Remove the ice basket, add water and detergent into the water reservoir, then hold and press “Clean” key for about 3 seconds, the “” indicator lights up and the appliance enters into the cleaning mode.

2. After cleaning for 8 minutes, the appliance stops working and the “” indicator flashes.



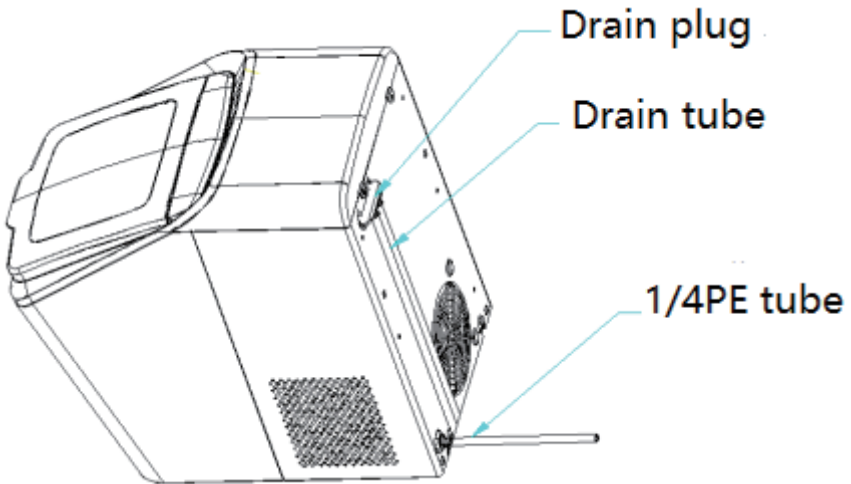

3. Remove the drain tube at the back of the appliance and place it at the dirty water outlet. Open the drain plug, and then the dirty water is drained from the drain tube until all the water inside the appliance is drained out.



4. Close the drain plug and fill the water reservoir with water. And then press “Clean” key again, the “” indicator lights up and the appliance enters into the cleaning mode.
  5. Repeat the operation of step 3 after the detergent inside the appliance is removed.
  6. Clean the inside of appliance with a piece of soft cloth soaked with warm water and vinegar.
  7. Rinse the drain tube and place the drain plug at the fixing groove at the back of appliance.
  8. Wash the ice basket and ice scoop in warm soapy water. Rinse and dry.
  9. Clean the exterior of the ice maker with a soft damp cloth. Use a mild dishwashing soap, if necessary.
- NOTE: Do not use organic solvent, boiled water, detergent, strong acid and strong alkali etc. for cleaning.
10. Please empty the water reservoir and dry it for storage if the ice maker is not used for a long time.



(Fig.1)

## TROUBLESHOOTING

Problem	Possible causes	Solution
 <p>flashes</p>	<ol style="list-style-type: none"> <li>1. Be lack of water.</li> <li>2. The water screen at the bottom of water reservoir is blocked.</li> <li>3. Pump malfunction.</li> <li>4. A foreign object blocked the float of water reservoir.</li> </ol>	<ol style="list-style-type: none"> <li>1. Stop making ice, refill water and then press "ON/OFF" key to restart ice-making cycle.</li> <li>2. Remove the water screen at the bottom for cleaning.</li> <li>3. Send it to the authorized department for repair.</li> <li>4. Check the foreign objects and restart the appliance.</li> </ol>
 <p>lights up</p>	<ol style="list-style-type: none"> <li>1. Ice basket is full.</li> <li>2. Malfunction of infrared ray.</li> </ol>	<ol style="list-style-type: none"> <li>1. Remove the ice from ice basket and then press "ON/OFF" key to restart the ice-making cycle.</li> <li>2. The sensor is damaged, please send it to the authorized department for repair.</li> </ol>
 <p>lights solidly</p>  <p>flashes</p>	<p>The ice-making assembly is defrosting.</p>	<p>No need to deal with it, the appliance will deal with it automatically, and it will return to normal operation after about 30-45 minutes.</p> <p>Alternatively, you can hold and press the "Clean" key for 3 seconds, and then press the "ON /OFF" key again to restart the appliance after the cleaning procedure is finished.</p>

 flashes   flashes	<p>The ice-making assembly is frozen.</p>	<p>No need to deal with it. Under this condition, let the appliance be defrosted automatically for about 20 minutes, at that time, the press keys can not be operated. The appliance can be used again after the defrosting is finished. If this problem occurs repeatedly, it can be considered as refrigerant leakage. Please send the appliance to the authorized department for maintenance.</p>
<p>Poor ice-making result. The ice-making process is normal but the ice produced is broken, which lasts for more than 2 hours.</p>	<ol style="list-style-type: none"> <li>1. Poor heat dissipation.</li> <li>2. The water temperature is too high.</li> <li>3. The ambient temperature is too high.</li> <li>4. The ice-making system is abnormal.</li> </ol>	<ol style="list-style-type: none"> <li>1. Leave a 5.91in clearance on all sides of the ice maker for proper ventilation.</li> <li>2. Fill the water reservoir with water ranges between 46.4 ℉ and 82.4 ℉</li> <li>3. Operate the ice maker at a environment with an ambient temperature between 50 ℉ and 89.6 ℉ .</li> <li>4. Call customer service.</li> </ol>

## TROUBLESHOOTING

Applicable climate:	ST/SN/N/T
Class:	I
Power source:	120V/60Hz
Rated power:	170W
Refrigerant/Refrigerant amount:	R600a / 0.044LBS
Foaming agent:	C5H10
Net weight:	34.2LBS
Housing:	SUS430
Unit size (D×W×H):	17.64 ×9.69×16.93 in