

# ASSEMBLY INSTRUCTION

## Friendly Reminder:

1. This sofa is packed in 6 boxes. Please assemble it after all boxes are received
2. As the cushions are all vacuum compressed, there will be some wrinkles. Please give your cushions up to 72 hours to reach its original size and the wrinkles will basically disappear.
3. Please do not open the compressed packages until your sofa frame is completely assembled.

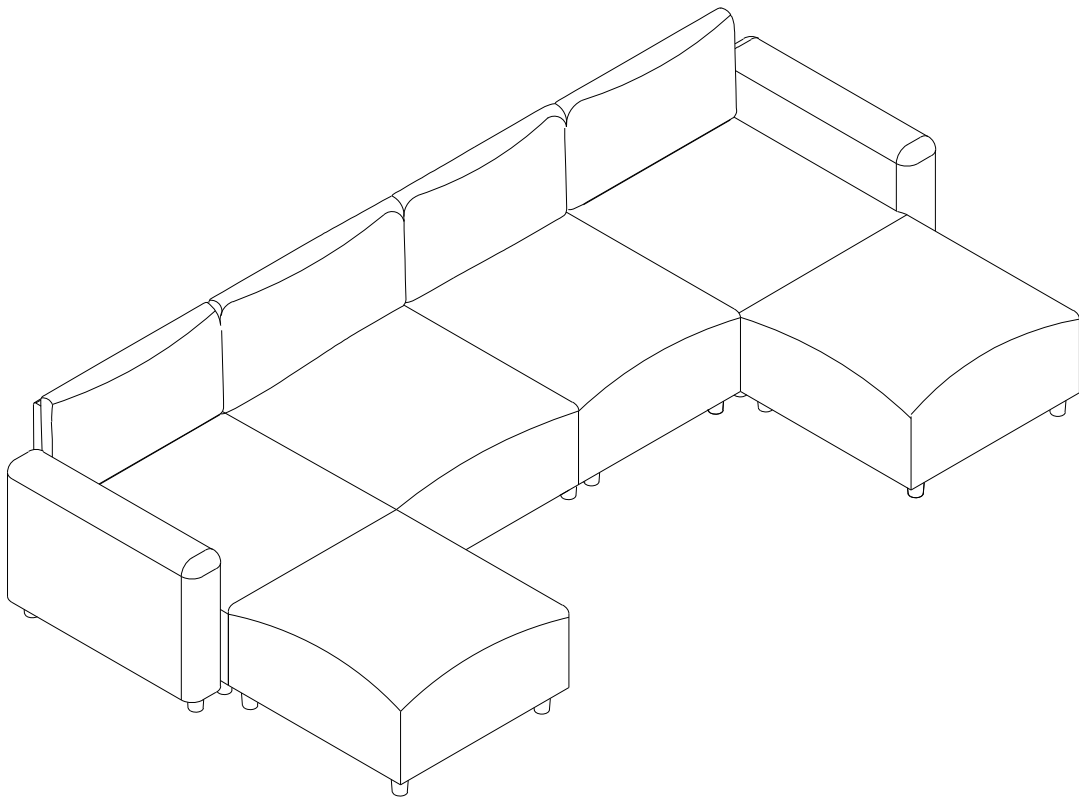



## Return & Warranty policy:

- We strive to offer the highest quality products, and we also try our best to satisfy each and every customer that orders from us with replacement parts or service as needed.
- If the item is damaged or defective, please take photos as evidence for replacements and refunds.
- Please do not return to store, contact the seller if you have any troubles with this product.

# ASSEMBLY INSTRUCTION

## HARDWARE

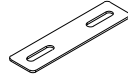
NO	DESCRIPTION	SKETCH	QTY
1	Legs		36
2	Plastic Gasket		50
3	Plate Metal		10

## PARTS LIST

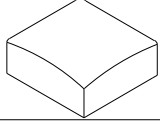
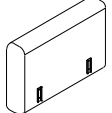
NO	DESCRIPTION	SKETCH	QTY
A	Ottoman		1
B	Left Armrest		1

## PARTS LIST

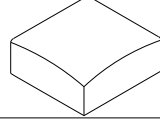
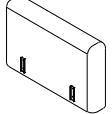
NO	DESCRIPTION	SKETCH	QTY
A	Ottoman		1
D	Right Armrest		1

# ASSEMBLY INSTRUCTION

## PARTS LIST

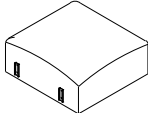
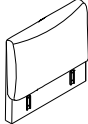
NO	DESCRIPTION	SKETCH	QTY
E	Left Seat Frame		1
F	Backrest		1

## PARTS LIST

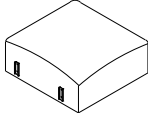
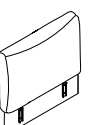
NO	DESCRIPTION	SKETCH	QTY
G	Middle Seat Frame		1
F	Backrest		1

## PARTS LIST

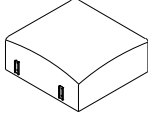
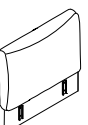

NO	DESCRIPTION	SKETCH	QTY
G	Middle Seat Frame		1
F	Backrest		1

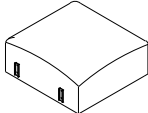
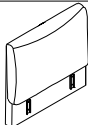
## PARTS LIST

NO	DESCRIPTION	SKETCH	QTY
H	Right Seat Frame		1
F	Backrest		1

# ASSEMBLY INSTRUCTION

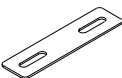

All parts and hardwares

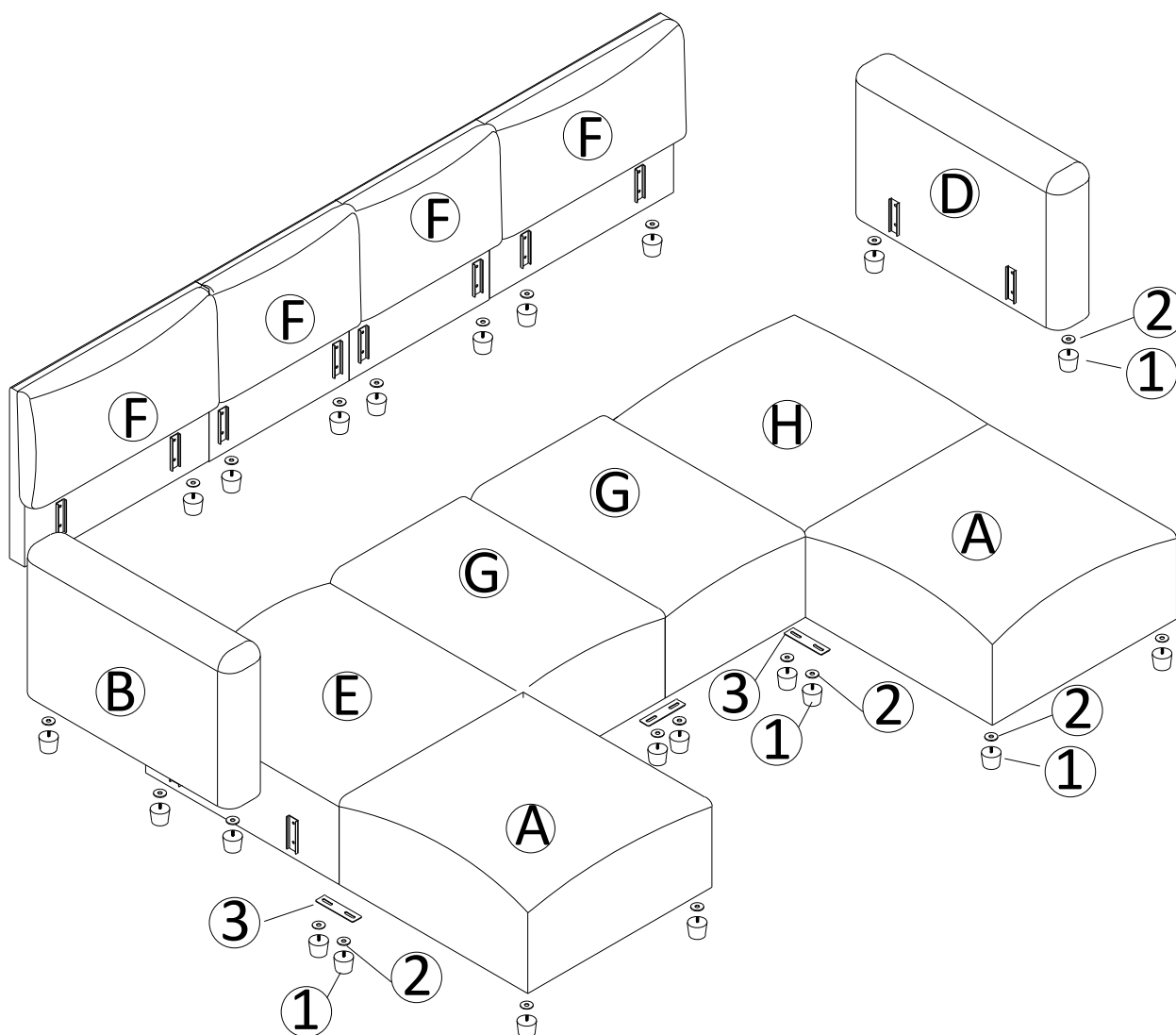
1		36
2		50
3		10



**DIAGRAM 1: Assemble the legs**

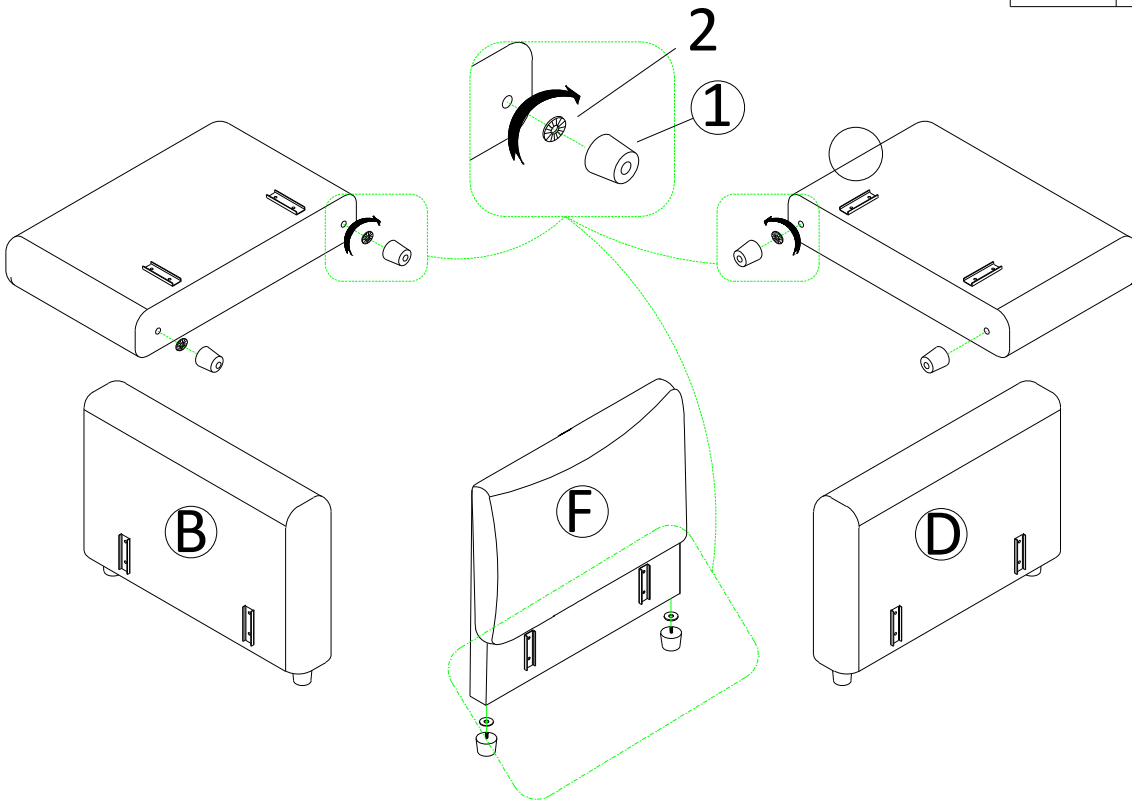

Tighten 2 legs (Hardware 1) of backrests and armrests by plastic gaskets (Hardware 2)

1		12
2		12



**DIAGRAM 2: Assemble the legs**

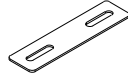

Use plate metals (Hardware 3) to connect middle seat frame (part G) and then tighten legs (Hardware 1) of them by plastic gaskets (Hardware 2).

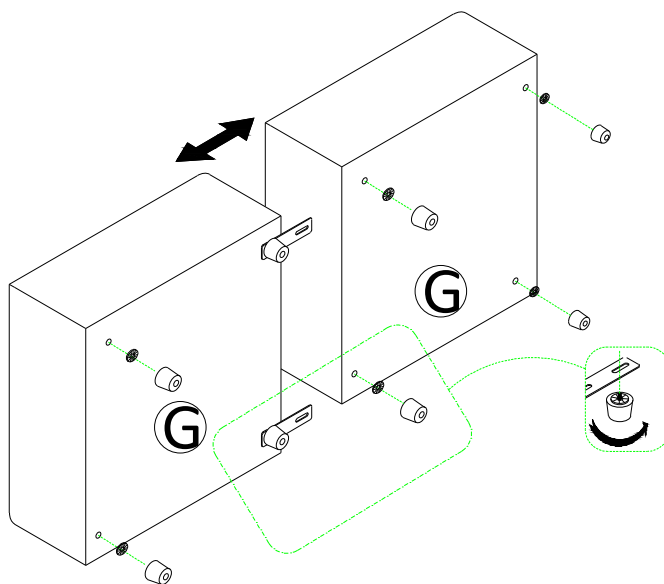
1		8
2		8
3		2



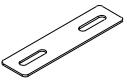

**DIAGRAM 3: Assemble the legs**

Use plate metals (Hardware 3) to connect left seat frame (part E), middle seat frames (part G), right seat frame (part H), and then tighten legs (Hardware 1) of them by plastic gaskets (Hardware 2).

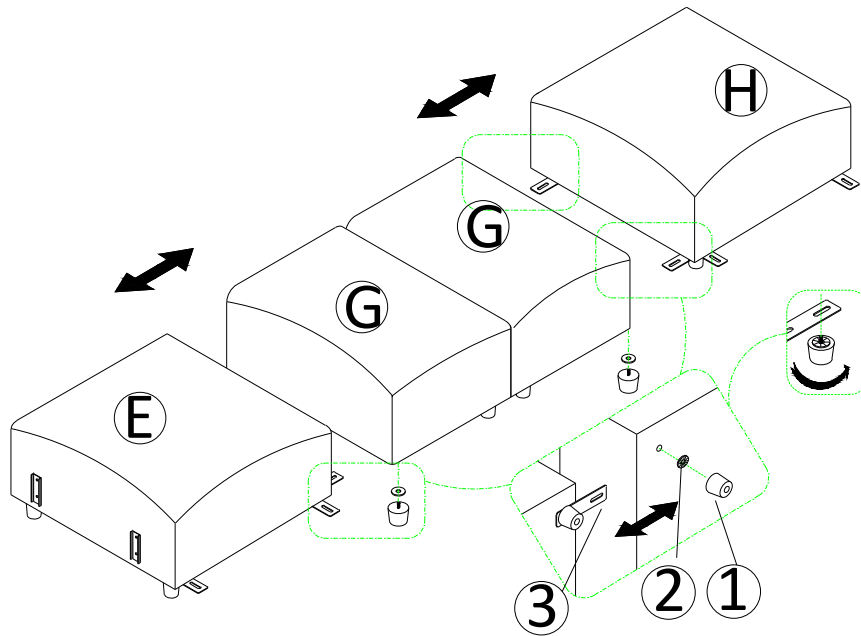
1		8
2		8
3		8

**DIAGRAM 4: Assemble the legs**

Use plate metals (Hardware 3) to connect left seat frame (part E) and ottoman (part A), right seat frame (part H) and ottoman (part A), and then tighten legs (Hardware 1) of them by plastic gaskets (Hardware 2).

1		8
2		8

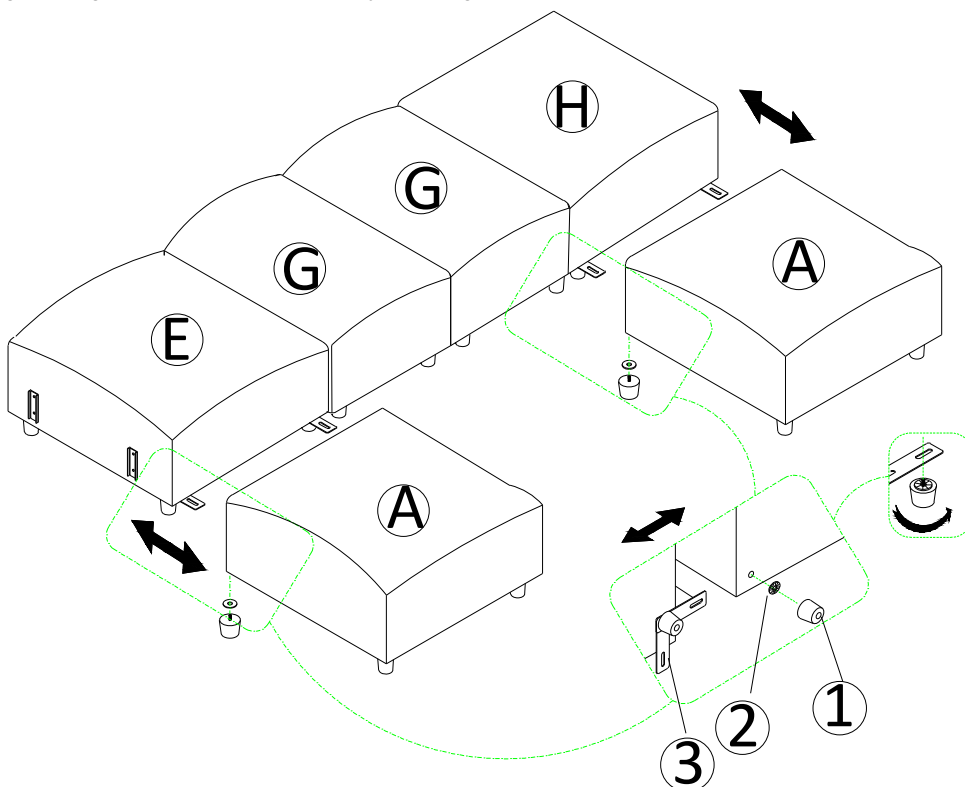

**DIAGRAM 5:**

Connect backrests and armrests to the seat frames .

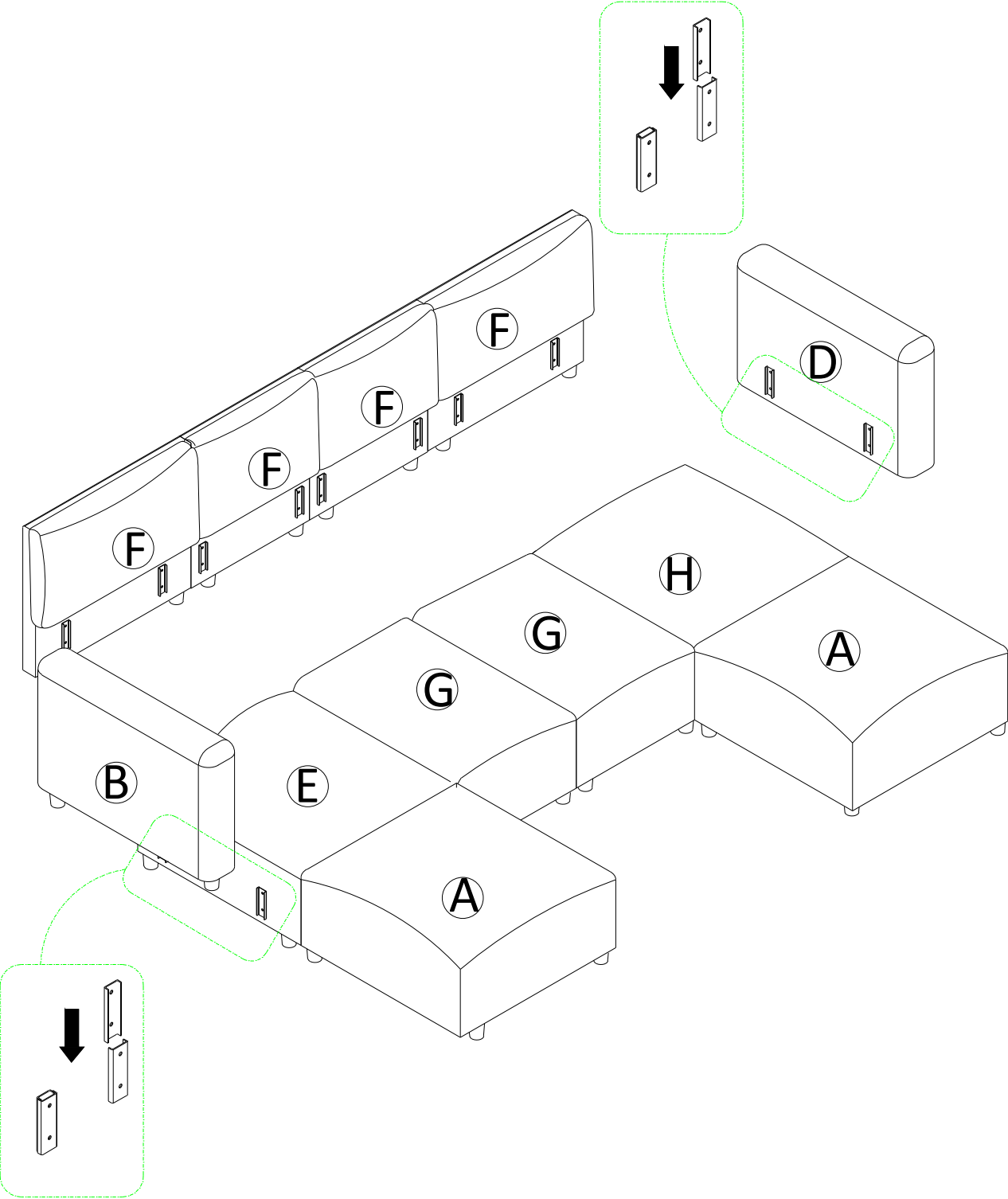

## TIPS

1. Please do not open the compressed packages until your sofa frame is completely assembled.
2. Compressed back cushions and pillows need to be fully fully fulfilled within 72 hours for your perfect use.
3. Please keep children away from plastic bags or any small pieces of stuff.

