

ASSEMBLY INSTRUCTION FOR TM00502 P1

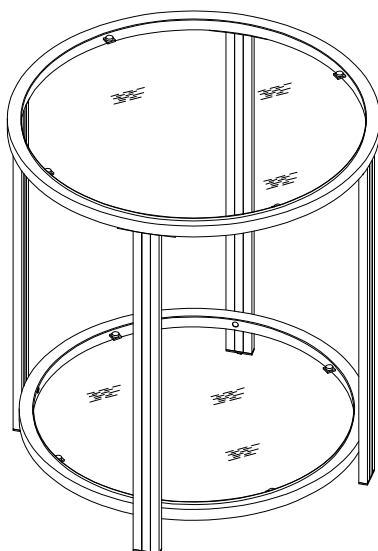

1

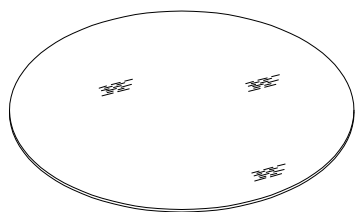

1PC

2

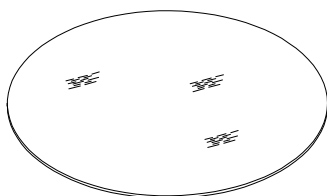

1PC

3

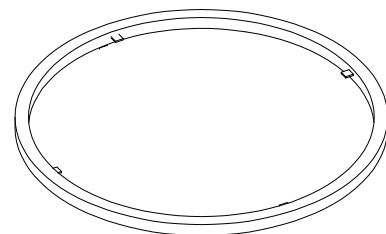

1PC

4

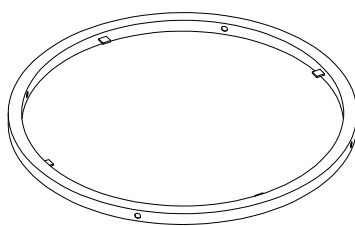

1PC

5

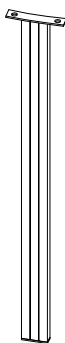

4PCS

A

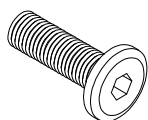

$\frac{1}{4}$ "*12mm
8PCS

B

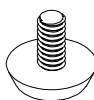

D12*10mm
4PCS

C



D10*3mm
8PCS

D

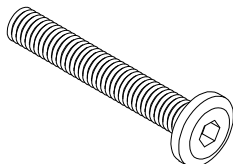

$\frac{1}{4}$ "*25mm
4PCS

E

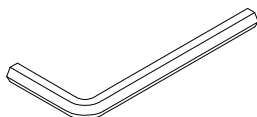

M4
1PC

ASSEMBLY INSTRUCTION FOR TM00502 P2

Step 1

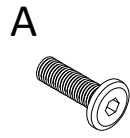

8PCS

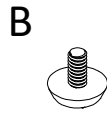

4PCS

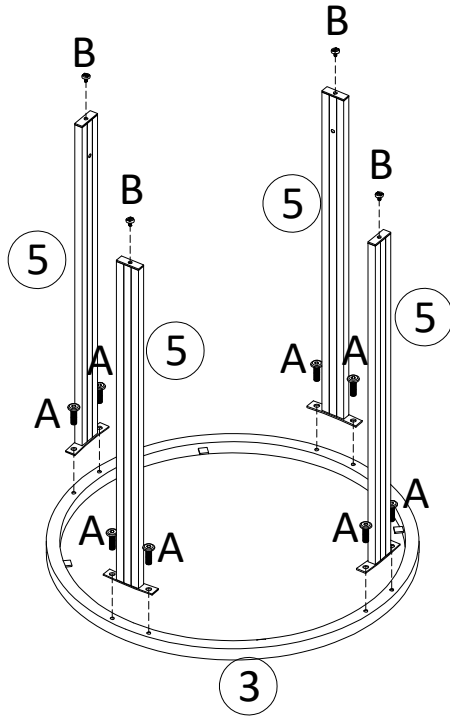

Step 2

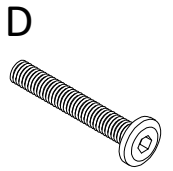

4PCS

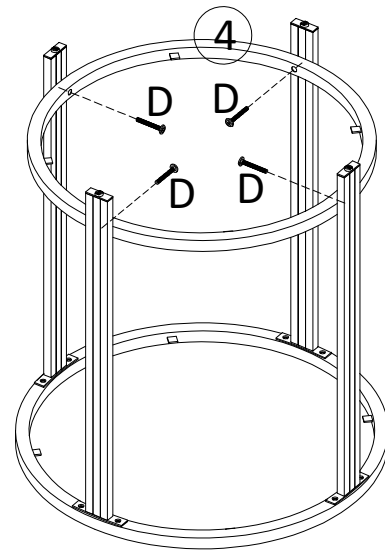

Step 3

C



8PCS

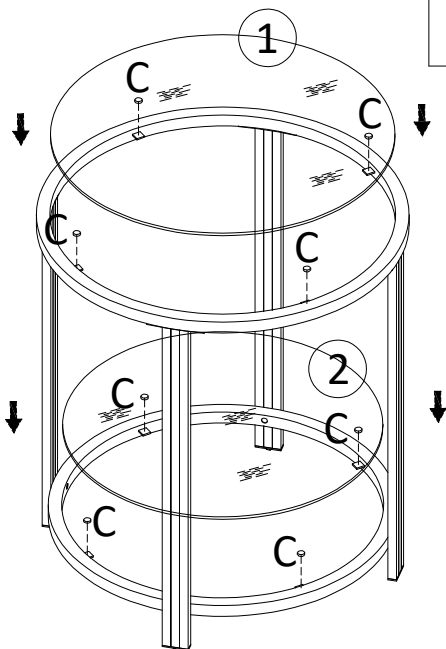

Step 4

