











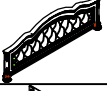









ASSEMBLY INSTRUCTIONS

ITEM NO: KING BED HB
 KING BED FB W/ SLATS
 5/0 & 6/0 SIDE RAILS

Thank you for purchasing this quality product. Be sure to check all packing material carefully for small parts, which may have come loose inside the carton during shipment. Identify and count all parts and compare with the HARDWARE LIST below.

NO.	PARTS LIST		Q'TY
A		Headboard	1
B		Headboard leg	2
C		Footboard	1
D		Side rail	2
E		Slat	4
F		Stretcher	1
G		Support leg	8

NO.	HARDWARE LIST		Q'TY
1		Ø5/16*2-1/4" Bolt	8
2		Ø5/16*13*1.2 Spring washer	8
3		Ø5/16*19*1.8 Flat washer	8
4		Ø1/4* 1 -1/2" Bolt	2
5		Ø1/4*13*1.2 Spring washer	2
6		Ø1/4*19*1.8 Flat washer	2
7		L57*4MM Allen wrench	1
8		Ø5/16*3" Bolt	8
9		"C" Washer	8
10		Ø5/16*13*1.2 Spring Washer	8
11		Ø5/16*16mm NUT	8
12		Allen Key	1
13		8*1" Wood Screw	8

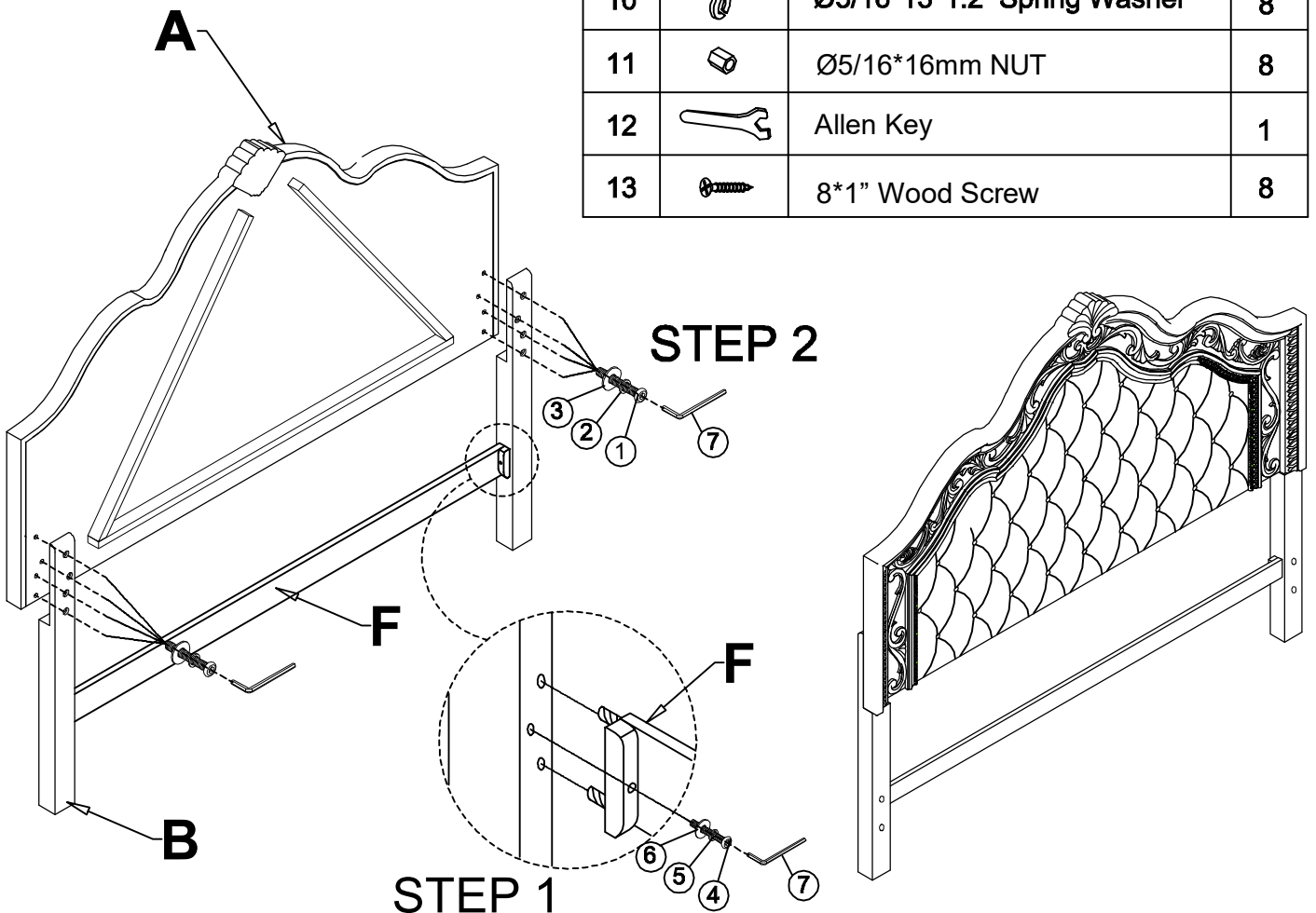

ASSEMBLY INSTRUCTIONS

ITEM NO: KING BED HB
KING BED FB W/ 4 SLATS
5/0 & 6/0 SIDE RAILS



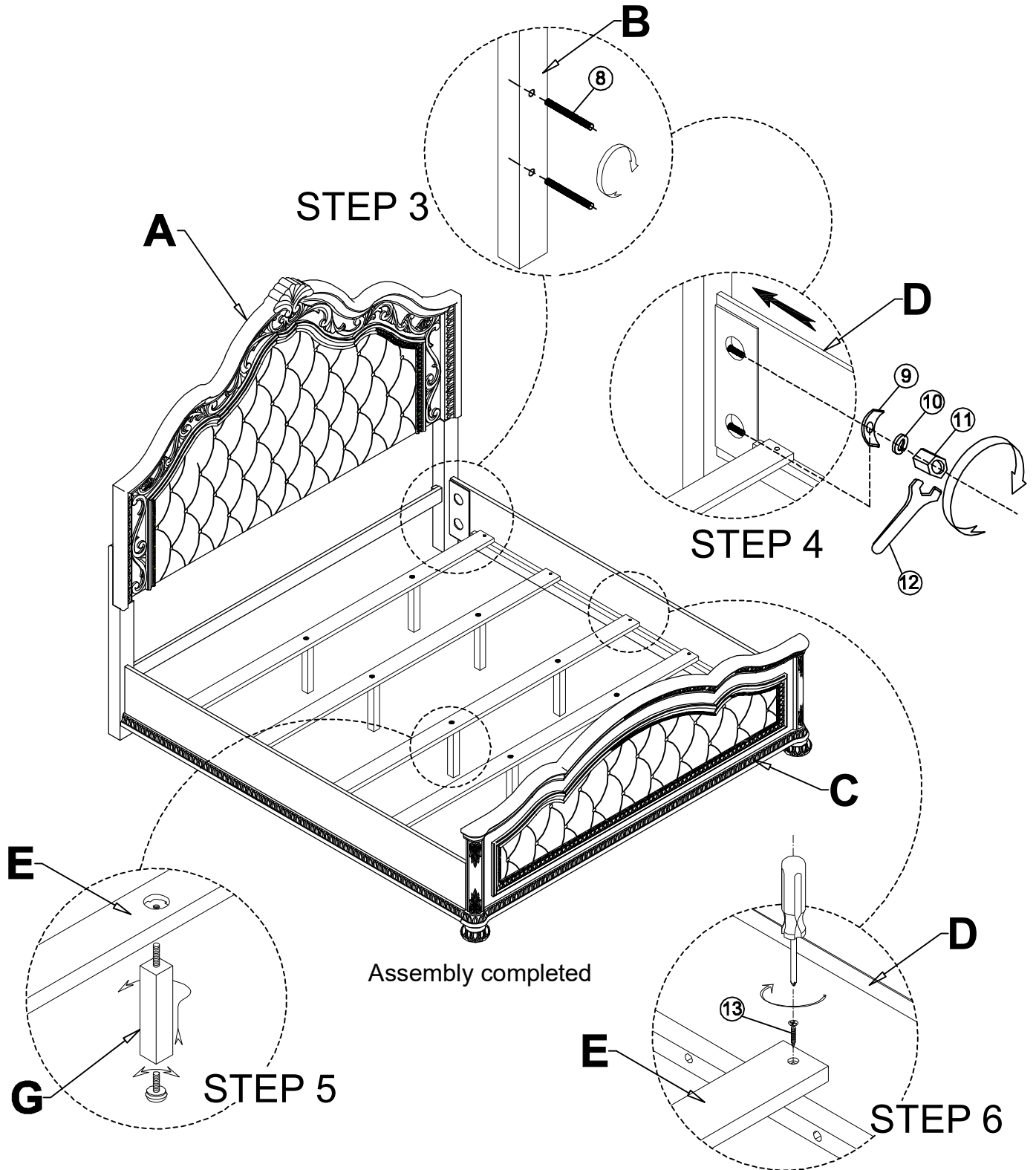



Thank you for purchasing this quality product. Be sure to check all packing material carefully for small parts, which may have come loose inside the carton during shipment. Identify and count all parts and compare with the **HARDWARE LIST** below.



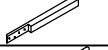











ASSEMBLY INSTRUCTIONS

ITEM NO: QUEEN BED HB
 QUEEN BED FB W/ SLATS
 5/0 & 6/0 SIDE RAILS

Thank you for purchasing this quality product. Be sure to check all packing material carefully for small parts, which may have come loose inside the carton during shipment. Identify and count all parts and compare with the HARDWARE LIST below.

NO.	PARTS LIST		Q'TY
A		Headboard	1
B		Headboard leg	2
C		Footboard	1
D		Side rail	2
E		Slat	4
F		Stretcher	1
G		Support leg	4

NO.	HARDWARE LIST		Q'TY
1		Ø5/16*2-1/4" Bolt	8
2		Ø5/16*13*1.2 Spring washer	8
3		Ø5/16*19*1.8 Flat washer	8
4		Ø1/4* 1 -1/2" Bolt	2
5		Ø1/4*13*1.2 Spring washer	2
6		Ø1/4*19*1.8 Flat washer	2
7		L57*4MM Allen wrench	1
8		Ø5/16*3" Bolt	8
9		"C" Washer	8
10		Ø5/16*13*1.2 Spring Washer	8
11		Ø5/16*16mm NUT	8
12		Allen Key	1
13		8*1" Wood Screw	8

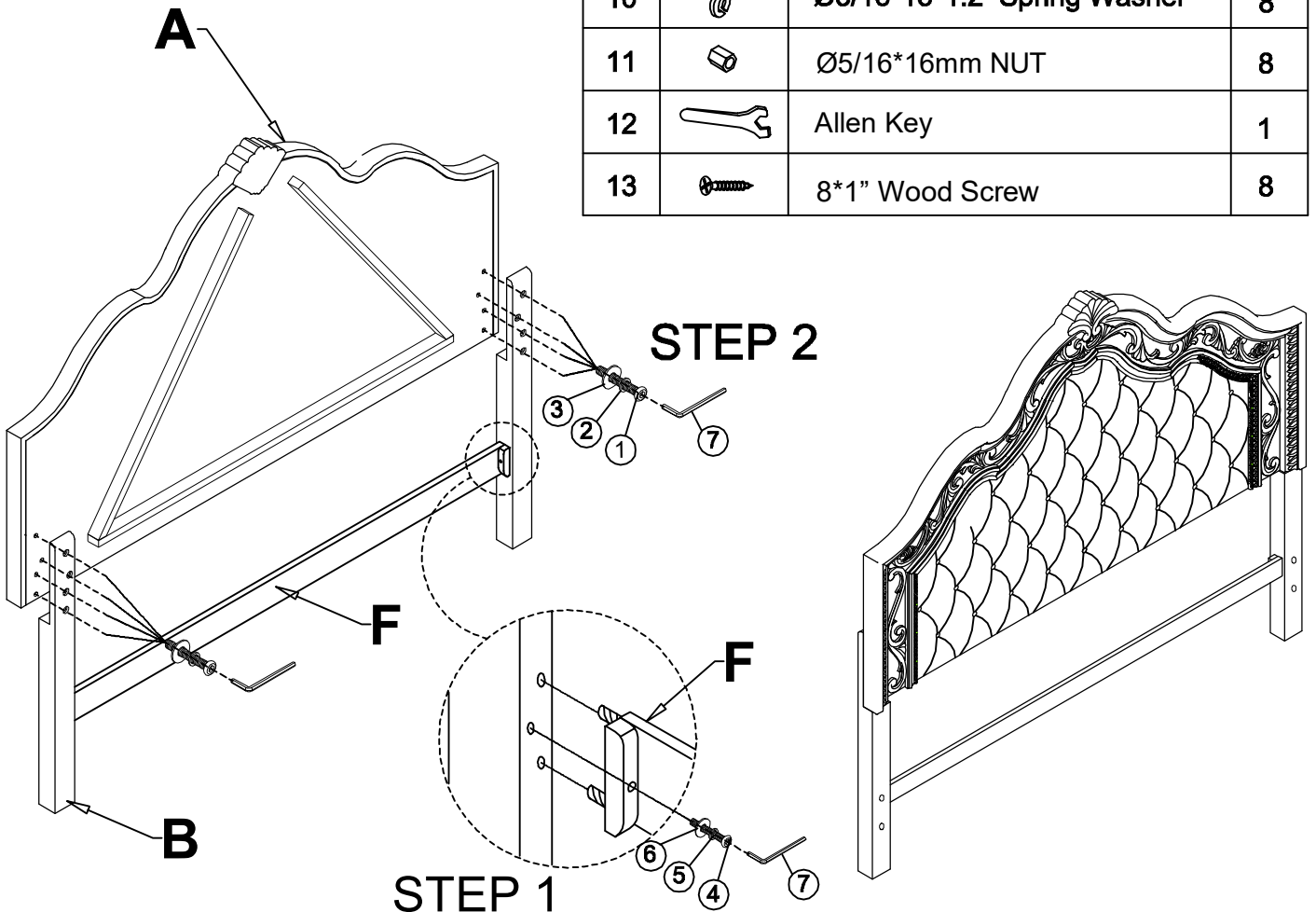

ASSEMBLY INSTRUCTIONS

ITEM NO: QUEEN BED HB
QUEEN BED FB W/ SLATS
5/0 & 6/0 SIDE RAILS

Thank you for purchasing this quality product. Be sure to check all packing material carefully for small parts, which may have come loose inside the carton during shipment. Identify and count all parts and compare with the **HARDWARE LIST** below.

