

INSTRUCTION

ANWEISUNG

取扱説明書

INSTRUCTION

제품 설명서

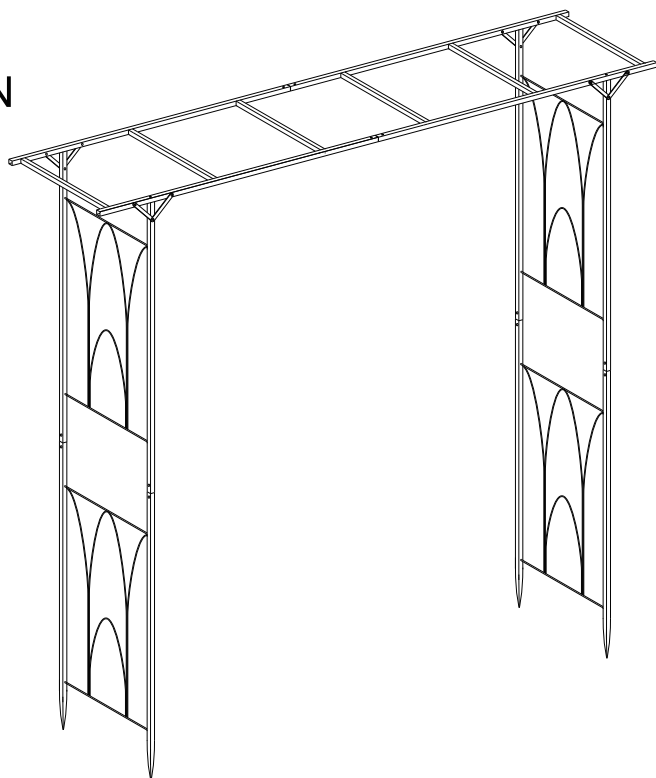

A *2

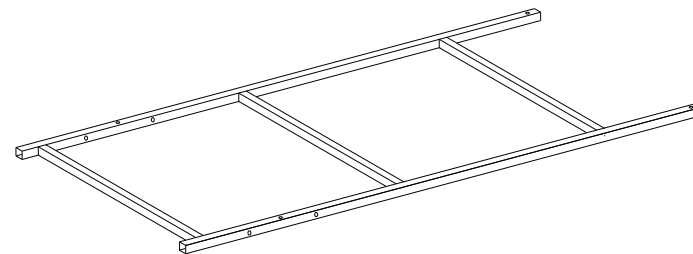

B *2

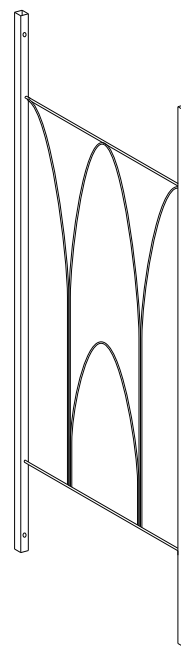

C *2

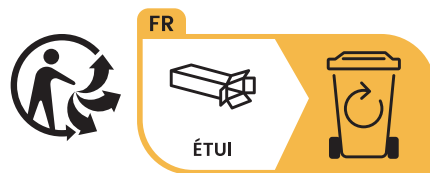
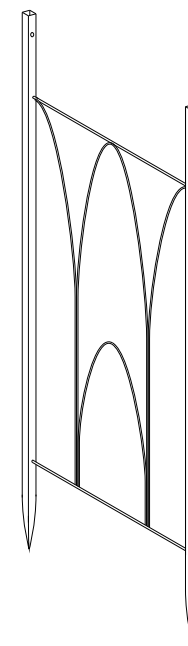

D *6

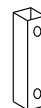

E *8

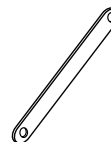

F *12



G *16

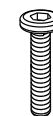

H *12



J *12



K *1

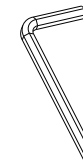

L *1

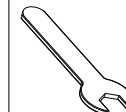

1

1. Install D to A with screws F

1. Installieren Sie bitte A und D mit Schraube F

1. 部品DとネジFで、2つの部品Aを繋ぎます

1. Veuillez installer A et D avec la vis F.

1. 나사 F로 D를 A에 설치하십시오.

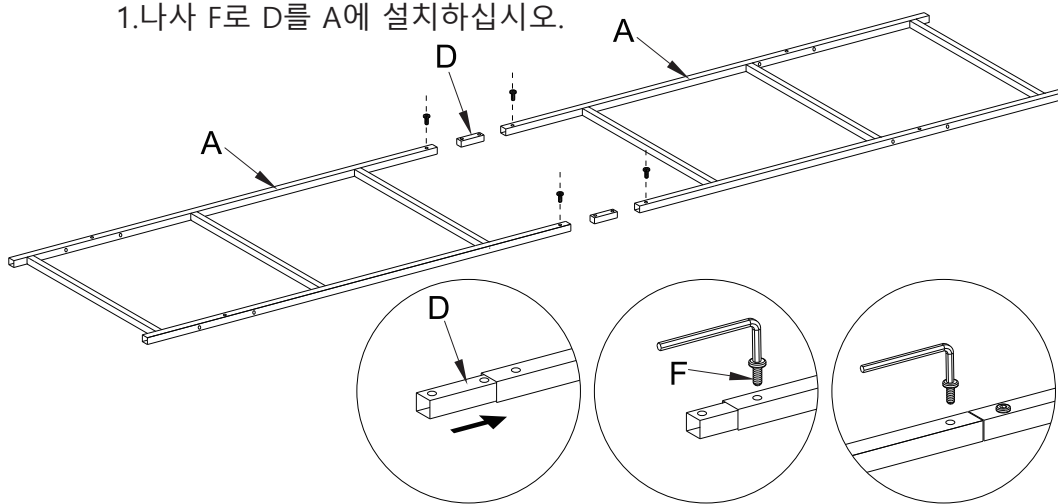
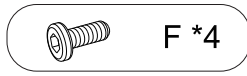

3

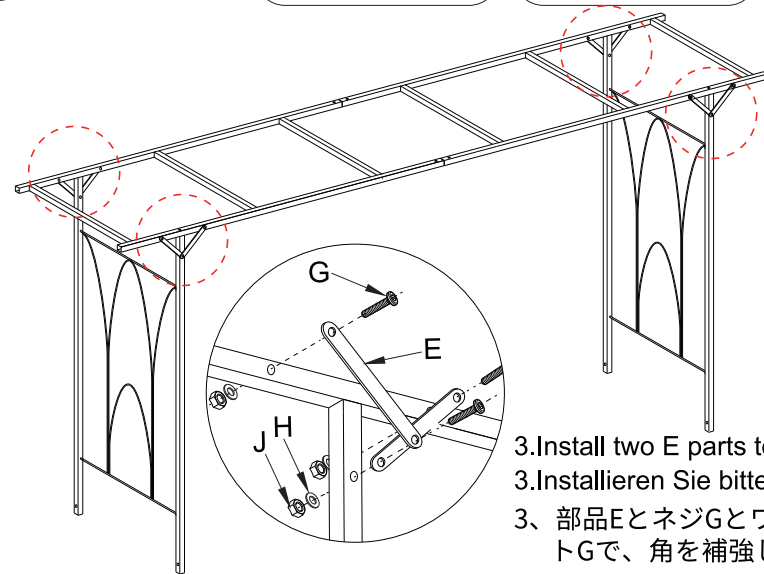
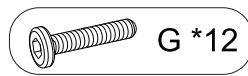

3. Install two E parts together
3. Installieren Sie bitte 2-tlg E

3. 部品EとネジGとワッシャーHとナットGで、角を補強します

3. Veuillez installer les deux parties E ensemble

3. 2개의 E 부품을 그림처럼 함께 설치하십시오.

2

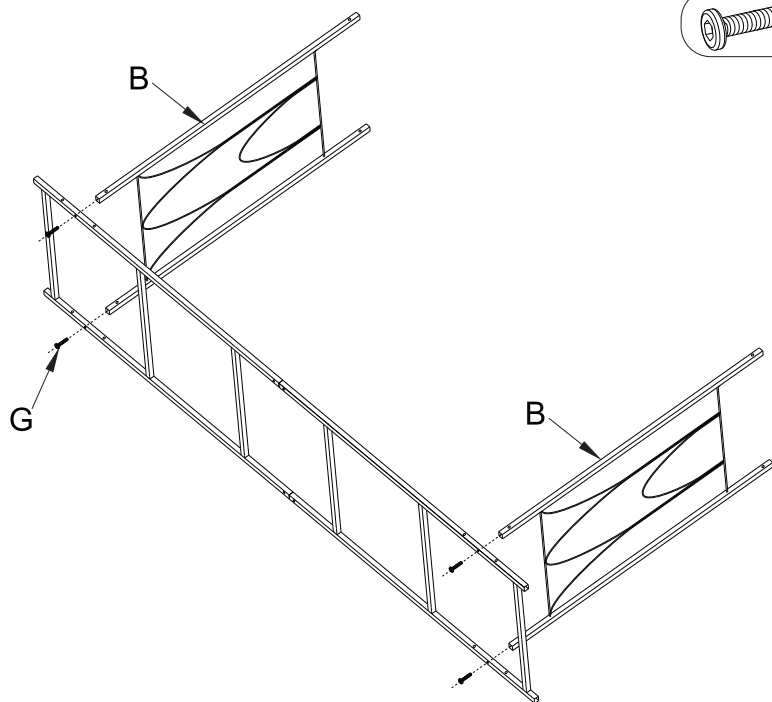

4

