







CARE AND MAINTENANCE

Wipe clean with a soft, dry cloth. The seat board can be cleaned with a mild cleaner. Test the cleaning method on a hidden area before using them over the entire area.

NOTICE

- * Please make sure that you have all parts indicated before you begin assembly of this item.
- * This item should be assembled on a soft surface to prevent scratching the finished product during assembly.
- * This item may require periodic tightening.
- * Do not tighten bolts until completely assembled.

Part List and Hardware List

Piece	Description	Picture	Quantity
A	Side Frame (Left)		1 X
B	Side Frame (Right)		1 X
C	Back Stretcher		1 X
D	Seat Frame		1 X
H1	Allen Bolt	 1/4"*5/8"	2 X
H2	Allen Bolt	 1/4"*1-1/2"	8 X
H3	Allen Key	 M4	1 X

Product Dimensions:25"W*30"D*32"H

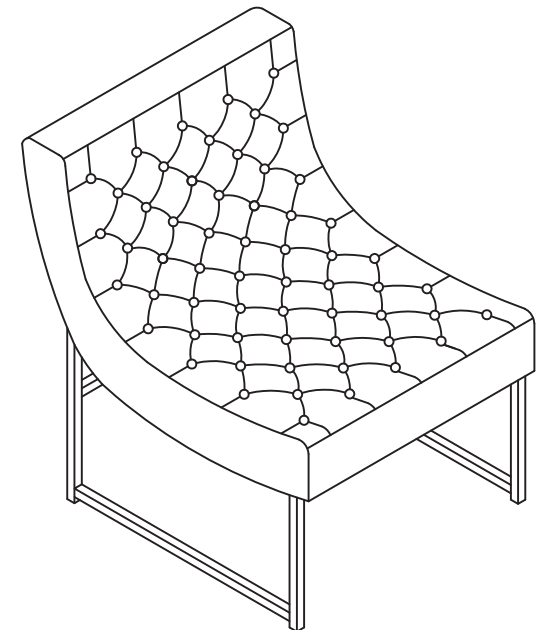

PREPARATION

Before beginning assembly of product, make sure all parts are present. Compare parts with package contents list and hardware contents list. If any part is missing or damaged, do not attempt to assemble the product.

Estimated Assembly Time:10 minutes.

Tools Required for Assembly (included):Allen Key.

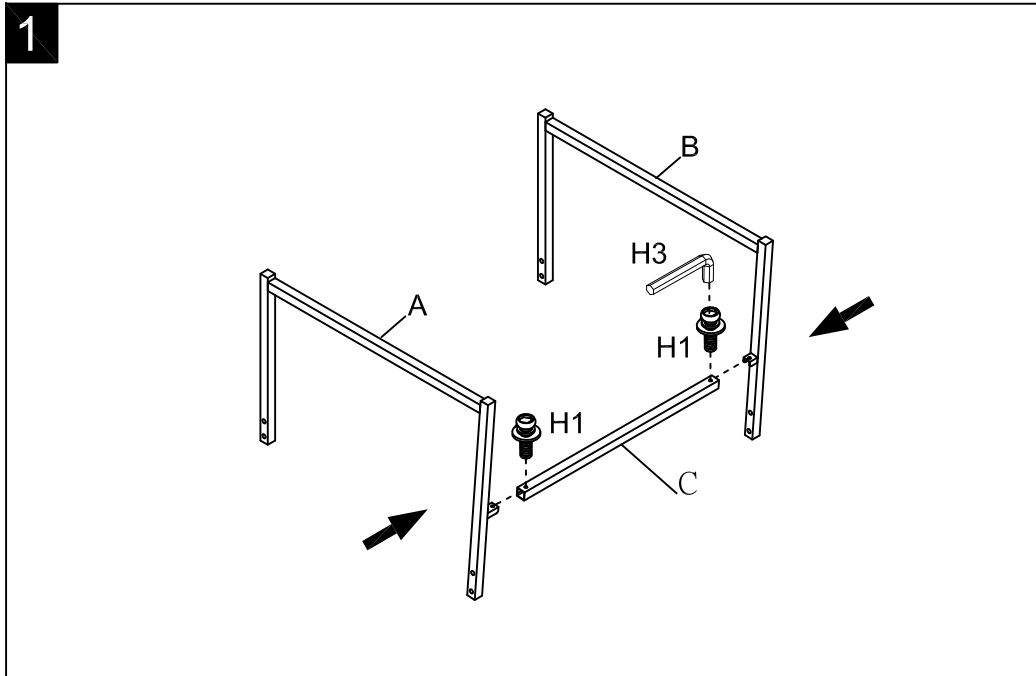

Step 1

Attach the back stretcher (C) to the side frame(Left) "A" and side frame(Right) "B", Using Allen key (H3) to lock with 2 Allen bolts (H1).

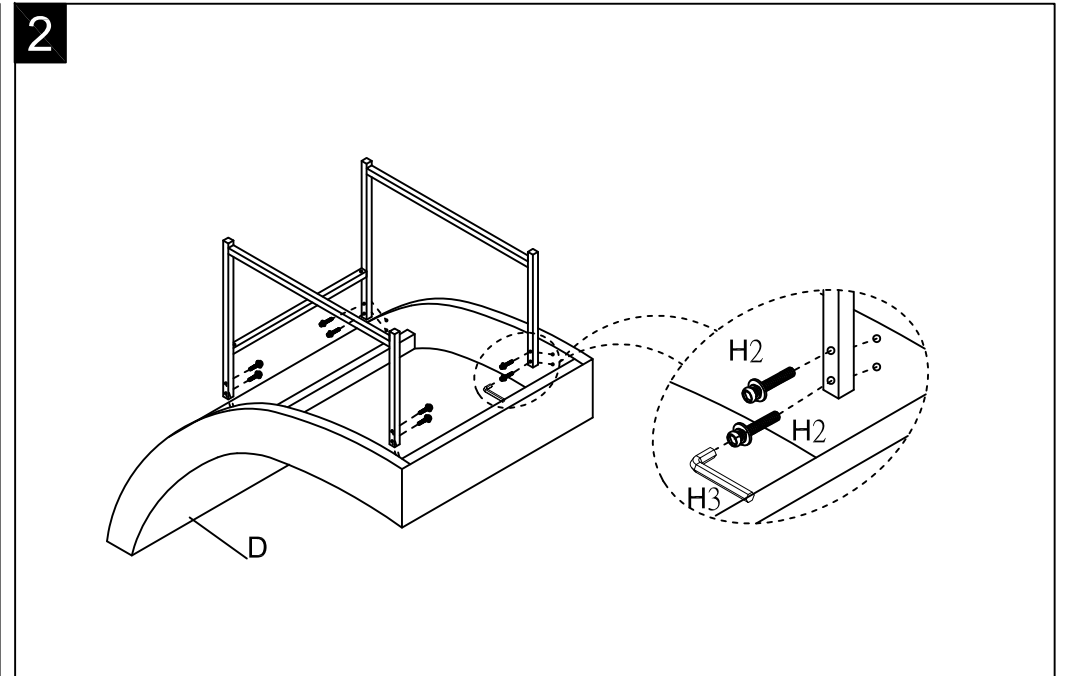

Step 2

Uncover Velcro fabric of seat frame back (D), Using Allen key (H3) to lock the assembled metal frame by 8 Allen bolts (H2). Cover the Velcro fabric to side of seat frame (D) and press together to close tight. Assembly completed.