

INSTALLATION INSTRUCTION

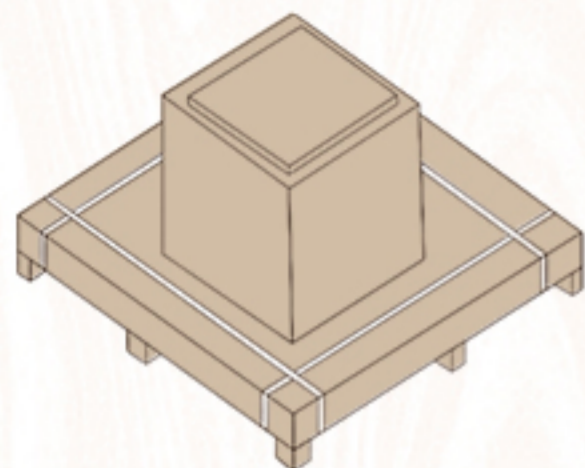

- ① Check the integrity of the outer box after receiving the package.

Note: Need to unpack and inspect all items: tabletop, connecting plate, and base.

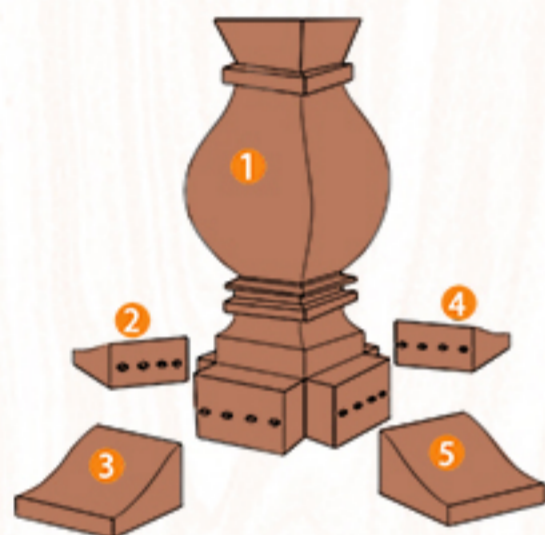

- ② There are four parts that need to be installed, as well as a base that connects them

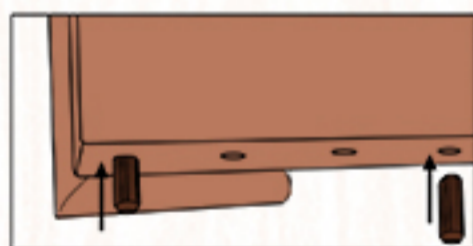

- ③ First, load the wooden stopper into the two holes near the edge of the base.

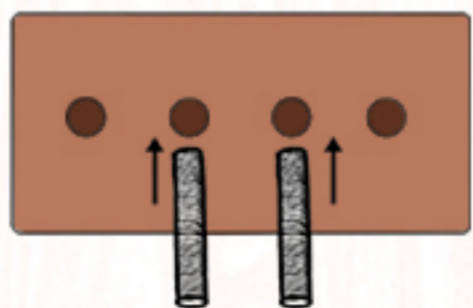

- ④ Rotate the long screws to the part to mount.

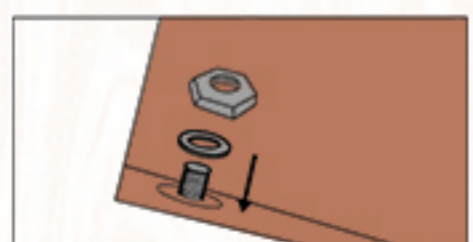

- ⑤ After the holes of the base and parts are aligned, we can start to tighten the screws in the base.
Note: All four parts are installed and screwed in the same way.

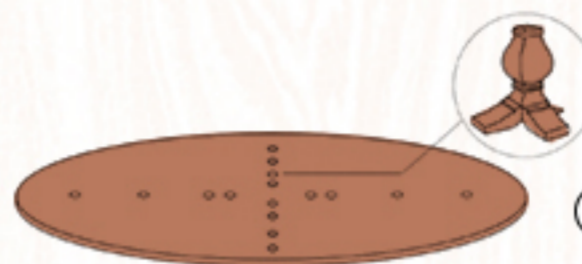

- ⑥ Plz place the small table on the tabletop



- ⑦ Once the four parts are installed, flip the base over and you're done.
Please be careful when flipping the base.

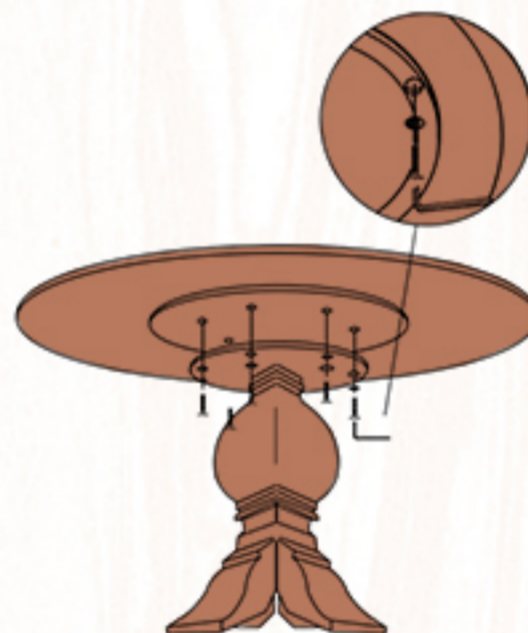

- ⑧ After the holes of the tabletop, connecting plate and chassis are aligned, we can start to screw the holes.

Tips: It is recommended not to tighten each screw too tightly at the



- ⑨ Assembly completed.