

Top View

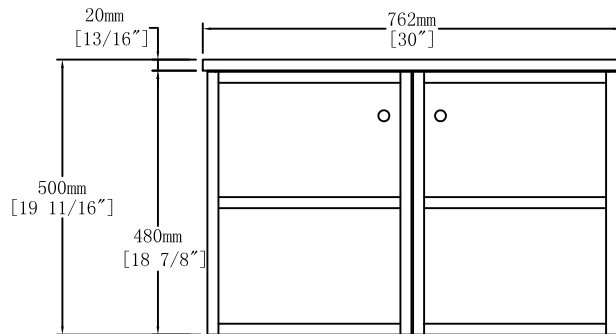

Front View

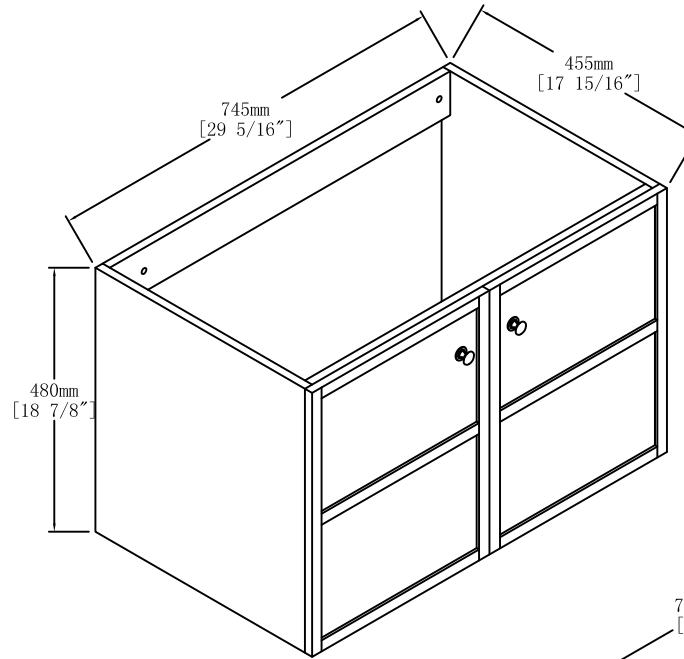
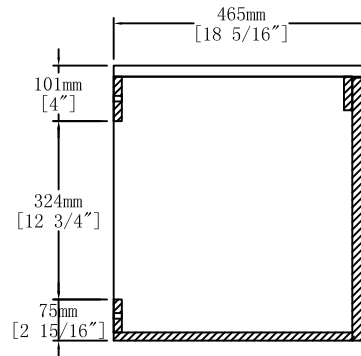

Side View

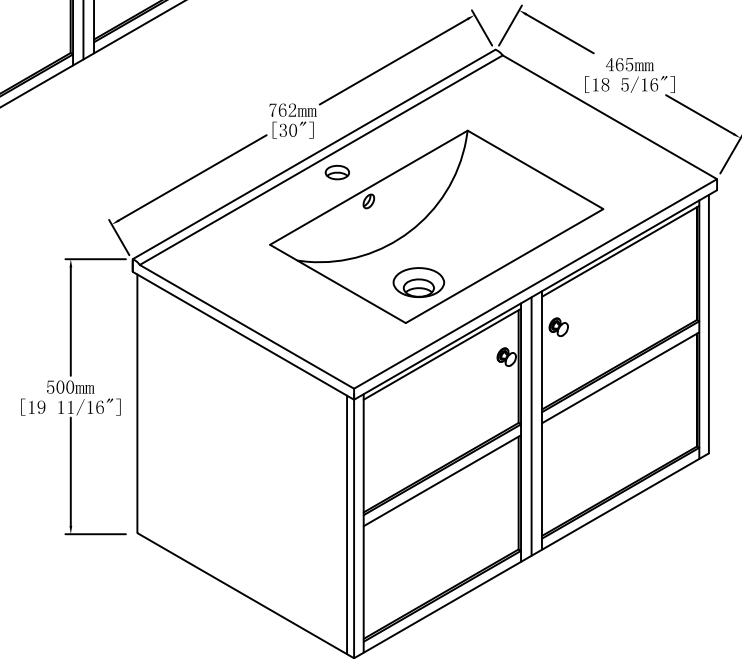

Item NO.

LV C1630

Version

V1

Project

Date

2024-8-24