

PATIO DINING CHAIR ASSEMBLY MANUAL

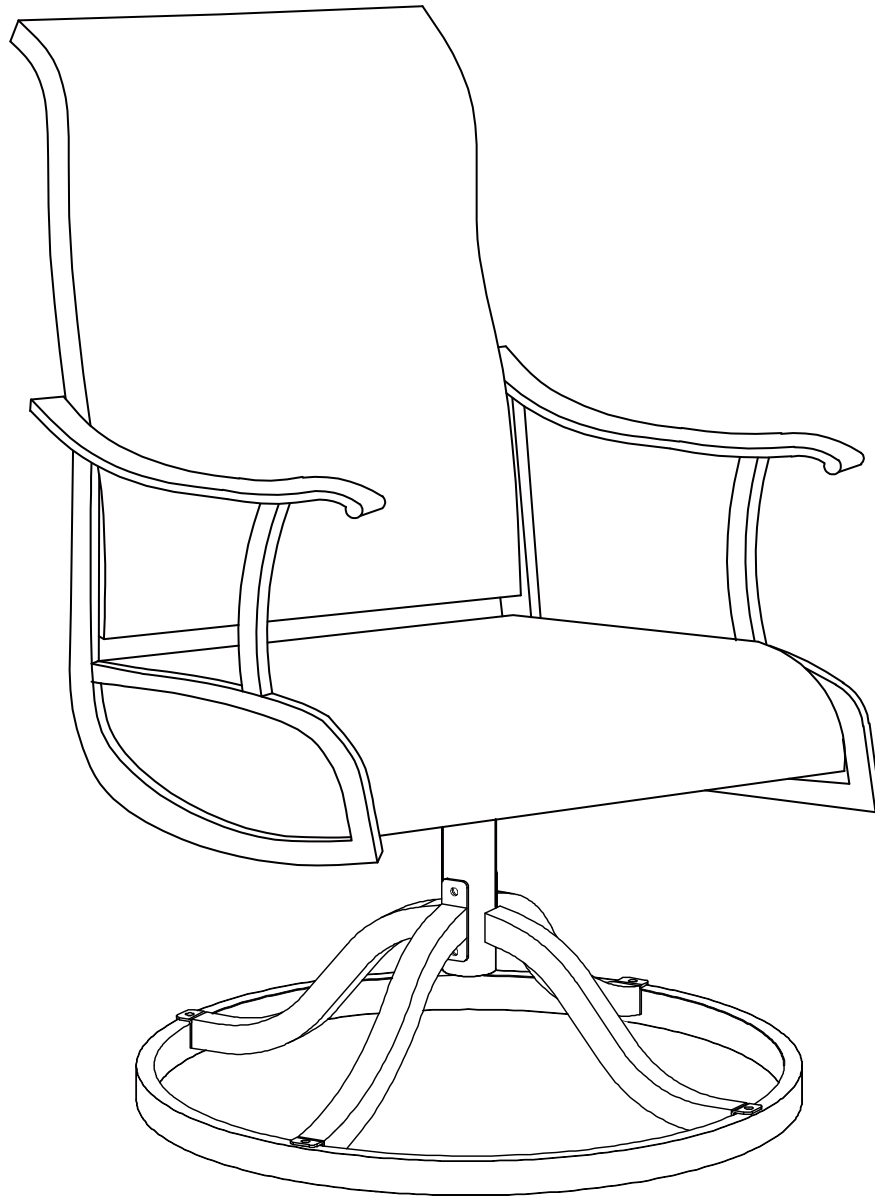

Dear Customer,

Thank you for choosing our product. Please read this manual carefully before assembling or using this product. If there are parts missing, please kindly send us messages to let us know the name of missing part regarding to the Parts List of instructions. We will send replacement to you asap.

PARTS LIST



NOTE!

This icon means how tight the screws should be tightened. Please follow this icon to ensure the installation is complete.

TOOLS REQUIRED

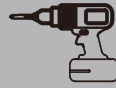









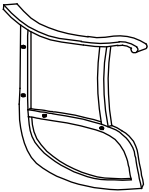
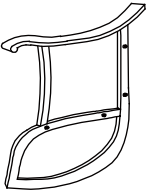
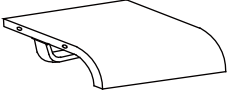
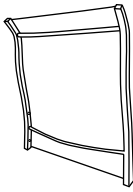
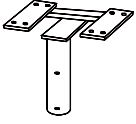
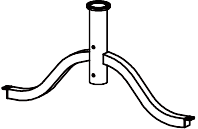

POWERDRILL

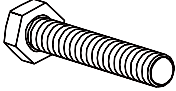
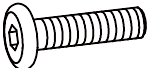
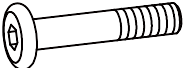

2 PERSON
ASSEMBLY

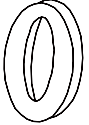

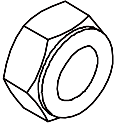

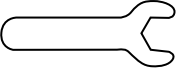
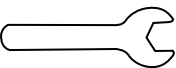



UP TO 15 MIN
ASSEMBLY

(A) 	(B) 	(C) 	(D) 	(E) 
1PC	1PC	1PC	1PC	1PC
(F) 	(G) 	(H) 	(K) 	(L) 
1PC	2PCS	1PC	2PCS	M8x35 4PCS
(M) 	(N) 	(O) 	(P) 	(Q) 
M6x35 8PCS	M6x60 2PCS	M6x16 4PCS	$\Phi 13 \times \Phi 6.5$ 14PC	$\Phi 16 \times \Phi 8.5$ 4PCS
(R) 	(S) 	(T) 	(U) 	(V) 
M8 4PCS	M8 4PCS	M6 2PCS	S4 1PC	M8 2PCS
				(W) 
				M6 1PC

STEP 1

Attach part E to seat C first, then secure part E with parts S/Q/R/K/L.

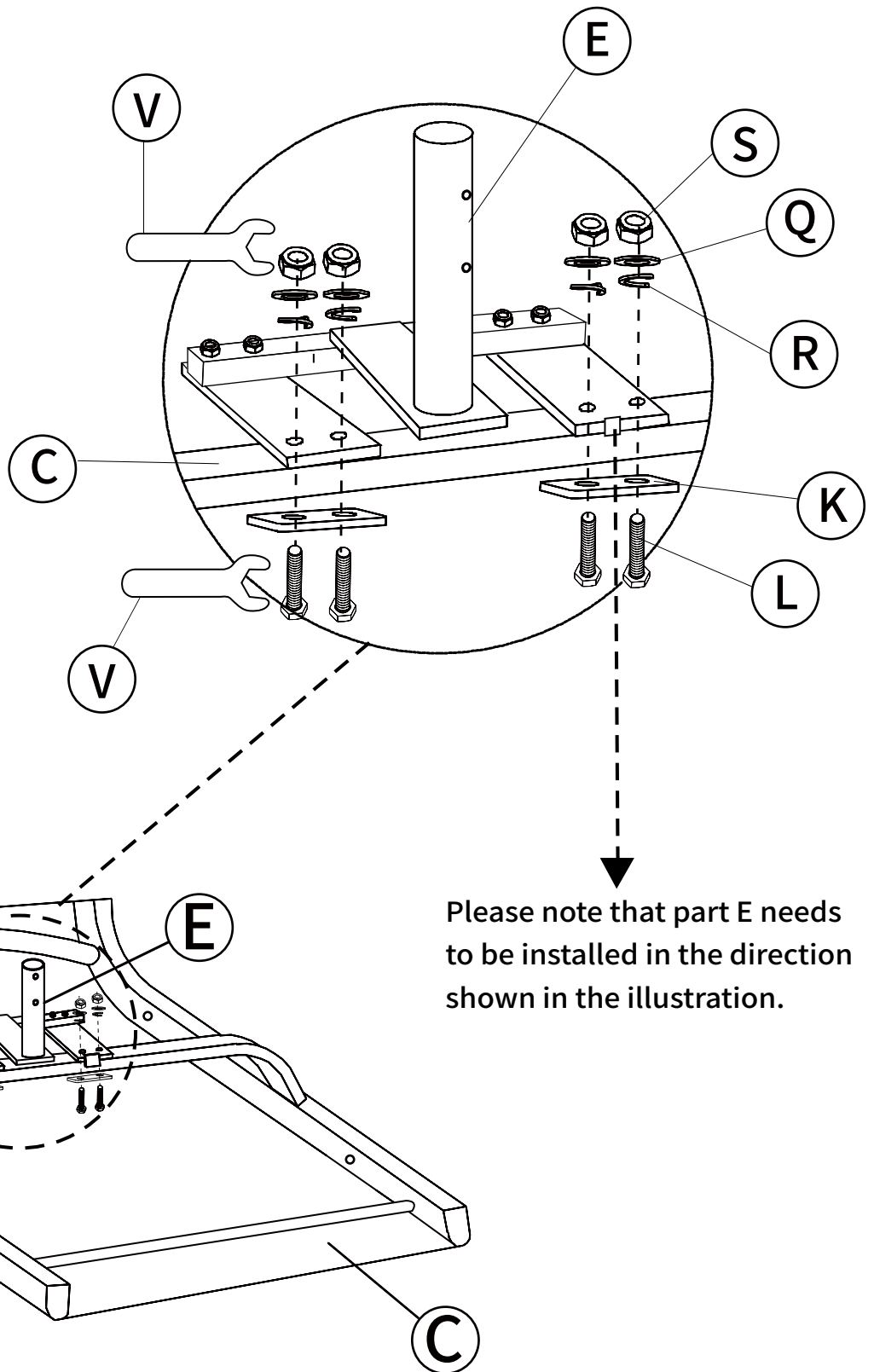

S		4PCS
Q		4PCS
R		4PCS
K		2PCS
L		4PCS
E		1PC
C		1PC



Please note that part E needs to be installed in the direction shown in the illustration.

STEP 2

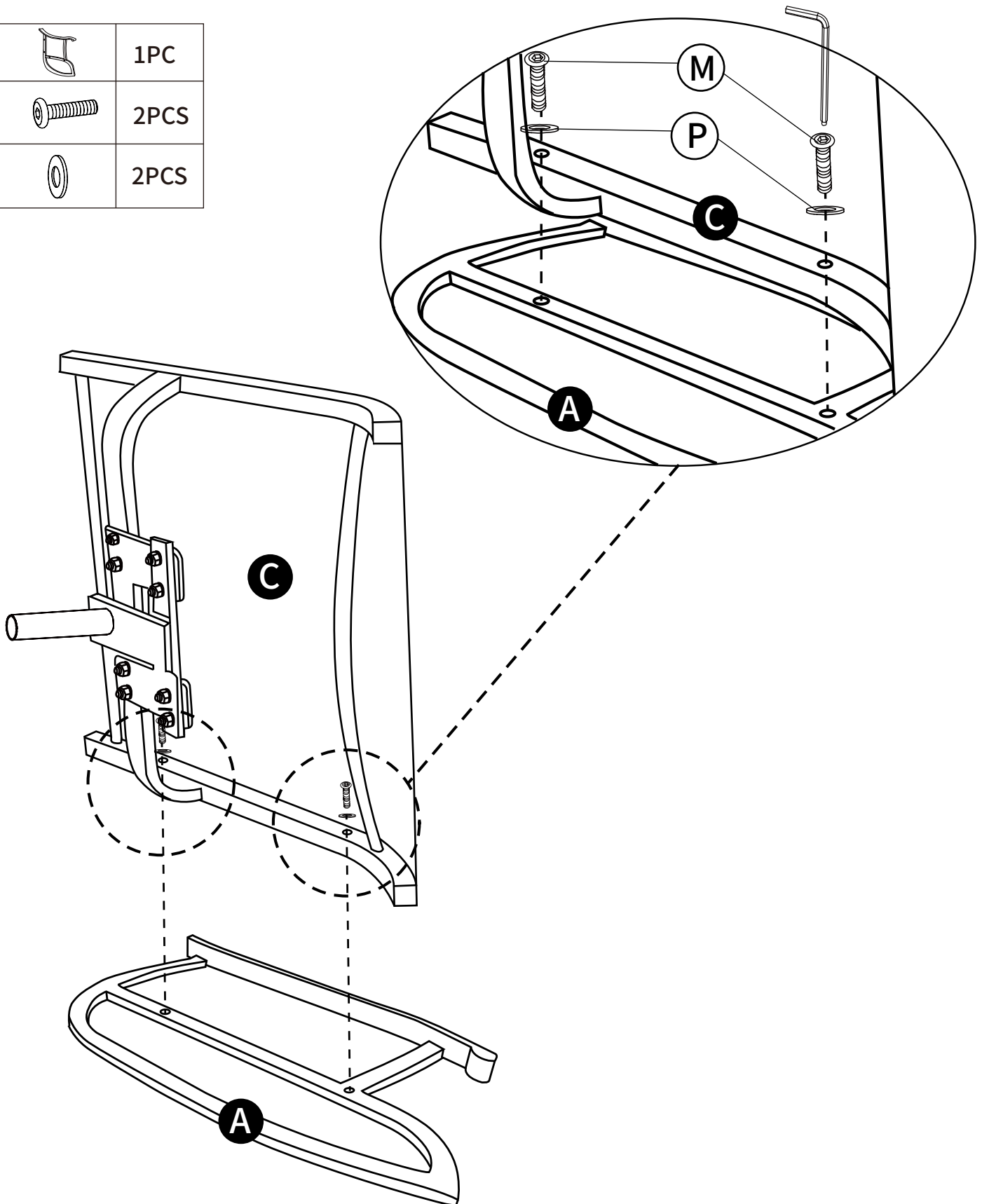

Place the armrest A on the ground in the orientation shown, then align the 2 holes in the seat and armrest. Secure the seat C and armrest A with 2 screws M and 2 spacers P.

A		1PC
M		2PCS
P		2PCS



STEP 3



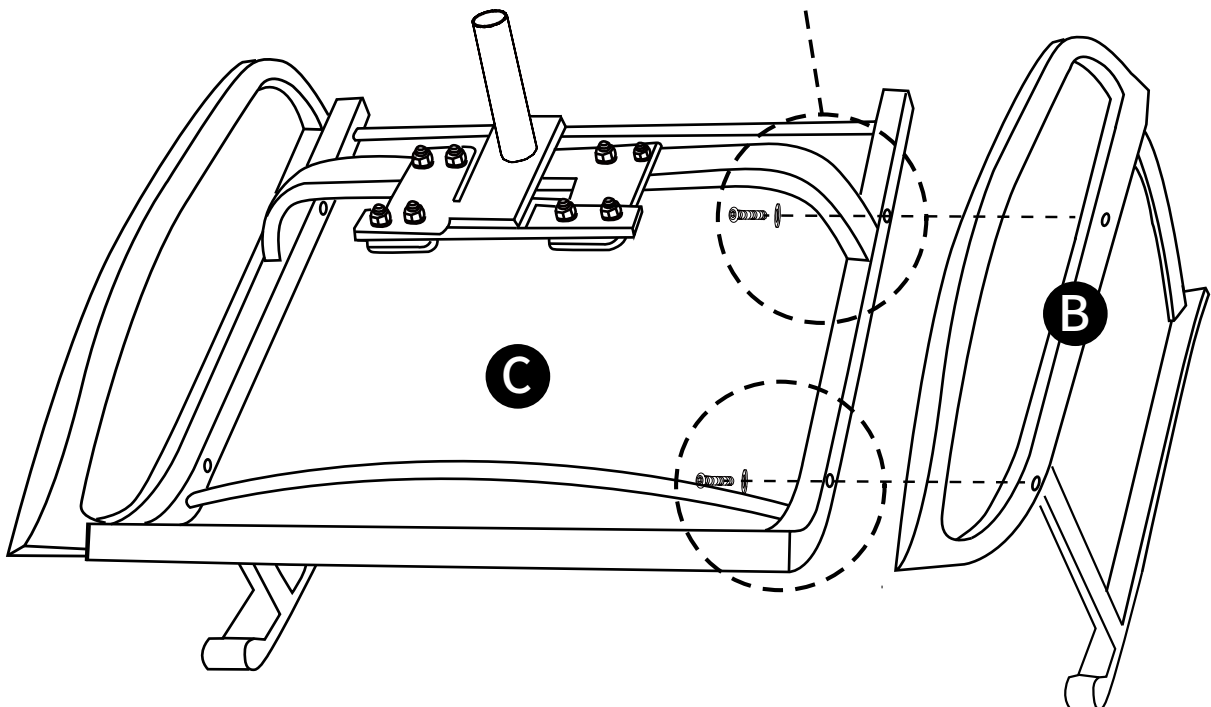
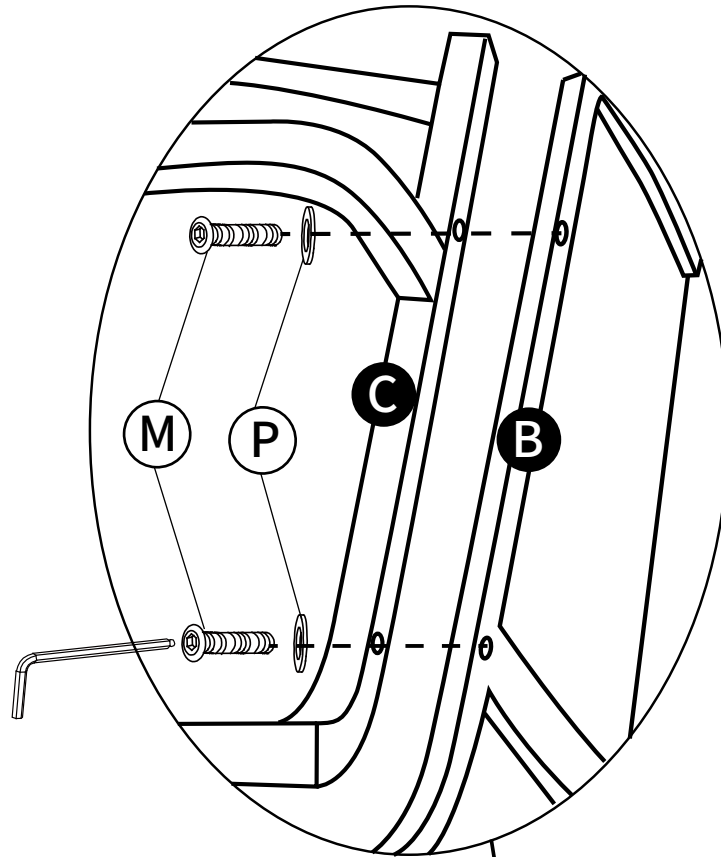
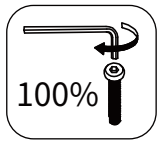

Place the armrest B on the ground in the orientation shown, then align the 2 holes in the seat and armrest. Secure the seat C and armrest B with 2 screws M and 2 spacers P.

B		1PC
M		2PCS
P		2PCS

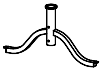

STEP 4



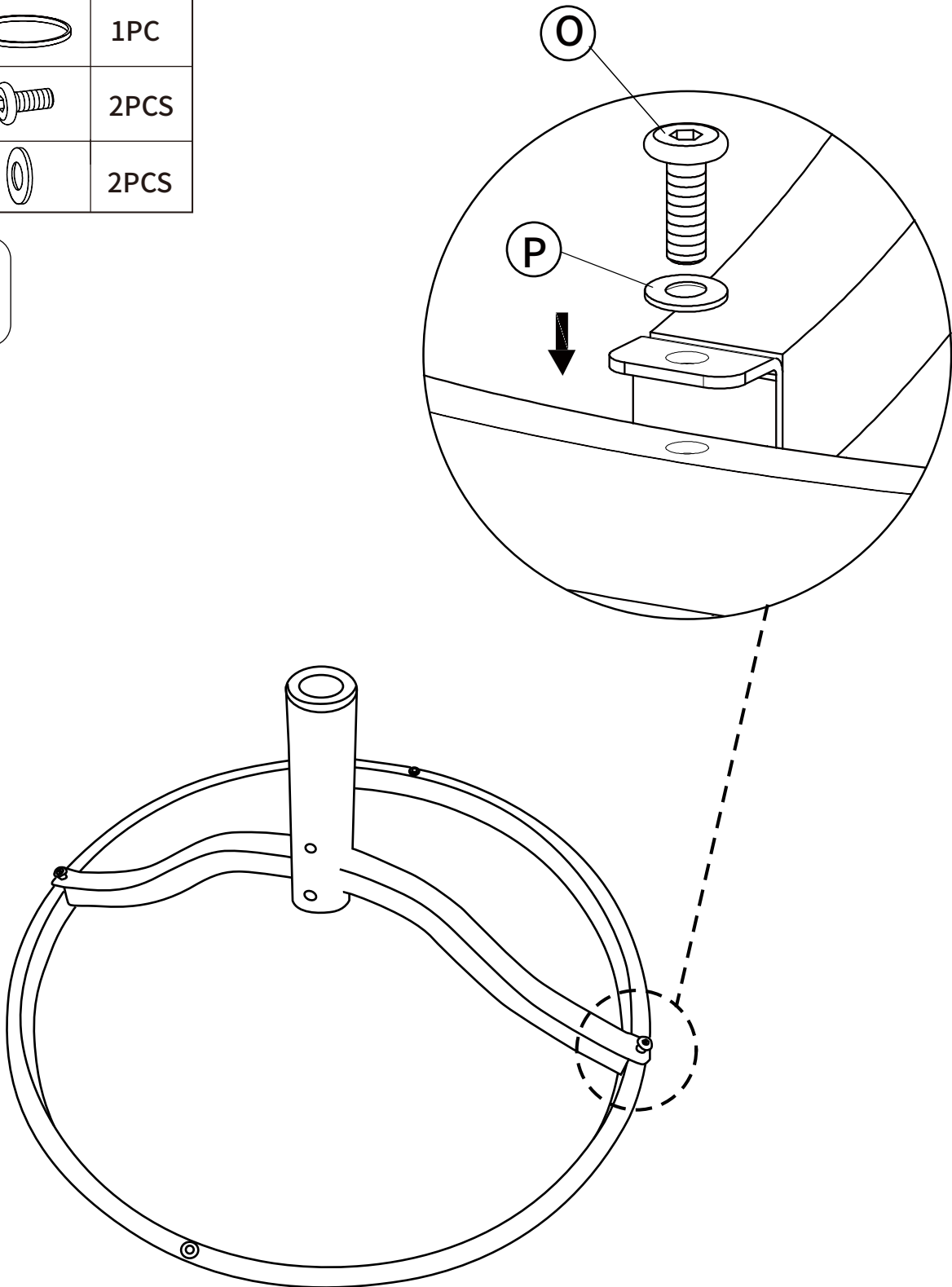
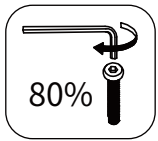

Attach part F to part H with parts O/P.

F		1PC
H		1PC
O		2PCS
P		2PCS

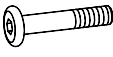

STEP 5

Attach 2 parts G to part H with parts O/P first, then attach 2 parts G to part F with parts N/P/T.

G		2PCS
O		2PCS
P		4PCS
N		2PCS
T		2PCS

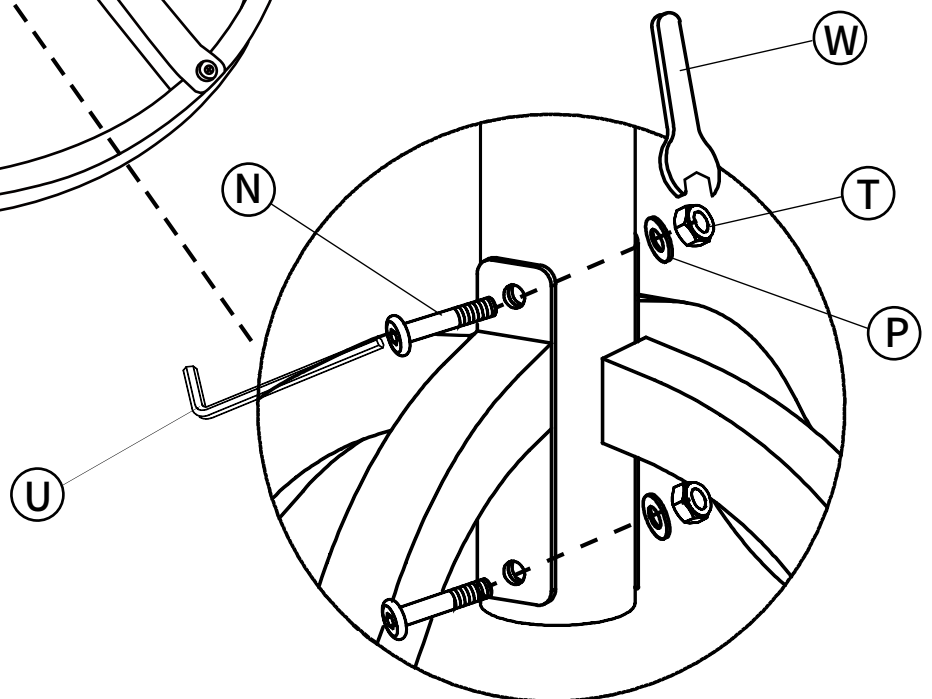
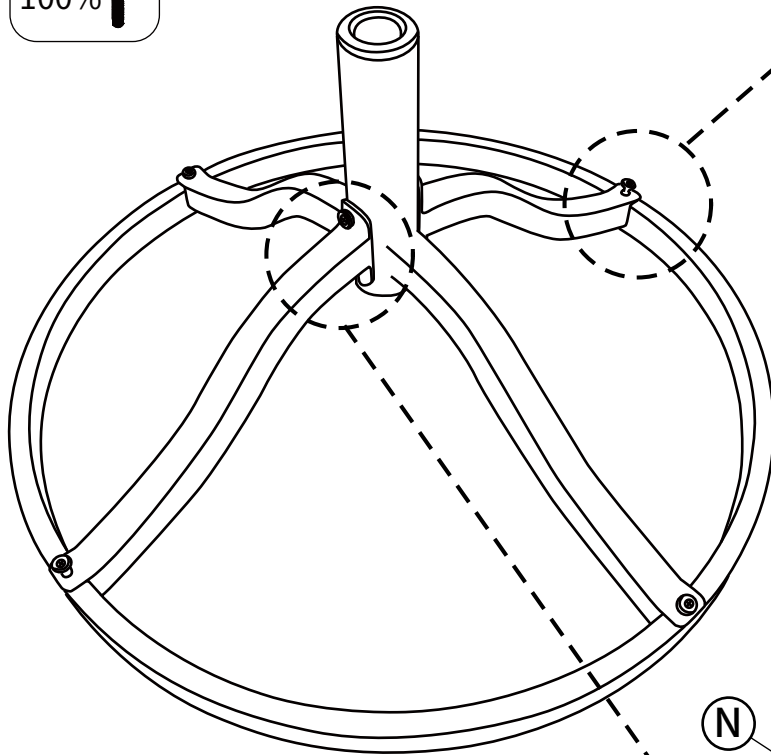
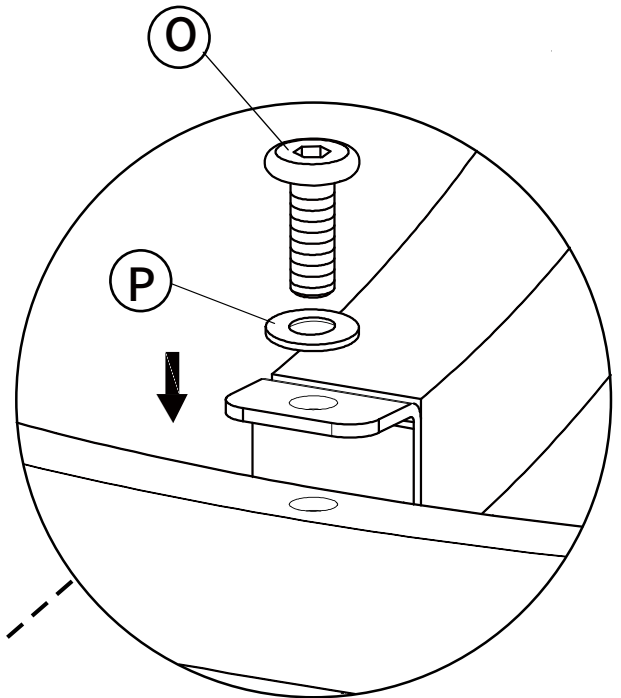

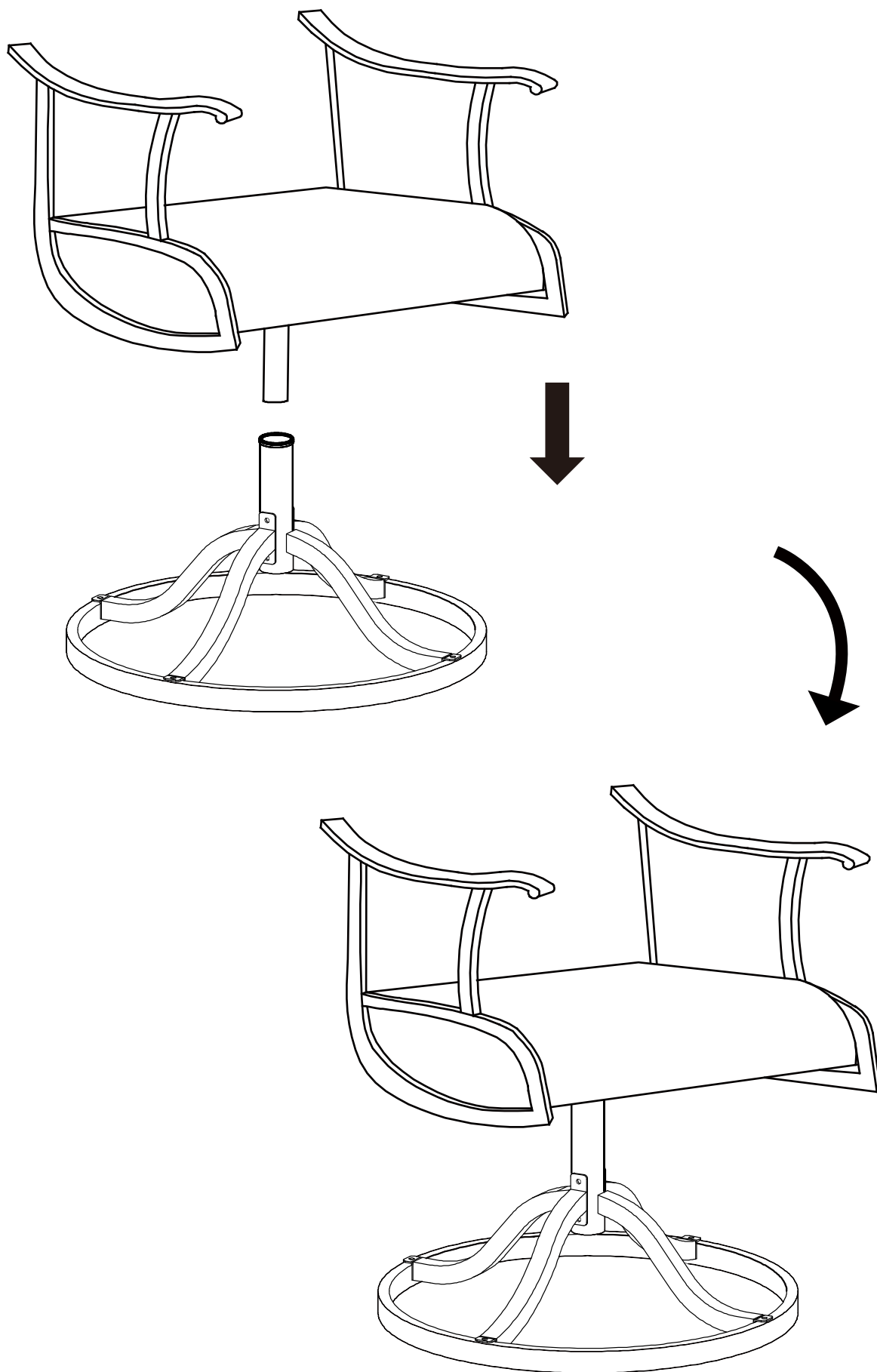

STEP 6

Insert seat C into chassis.

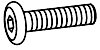

STEP 7

Secure armrests and backrest D with 4 screws M and 4 spacers P.

D		1PC
M		4PCS
P		4PCS

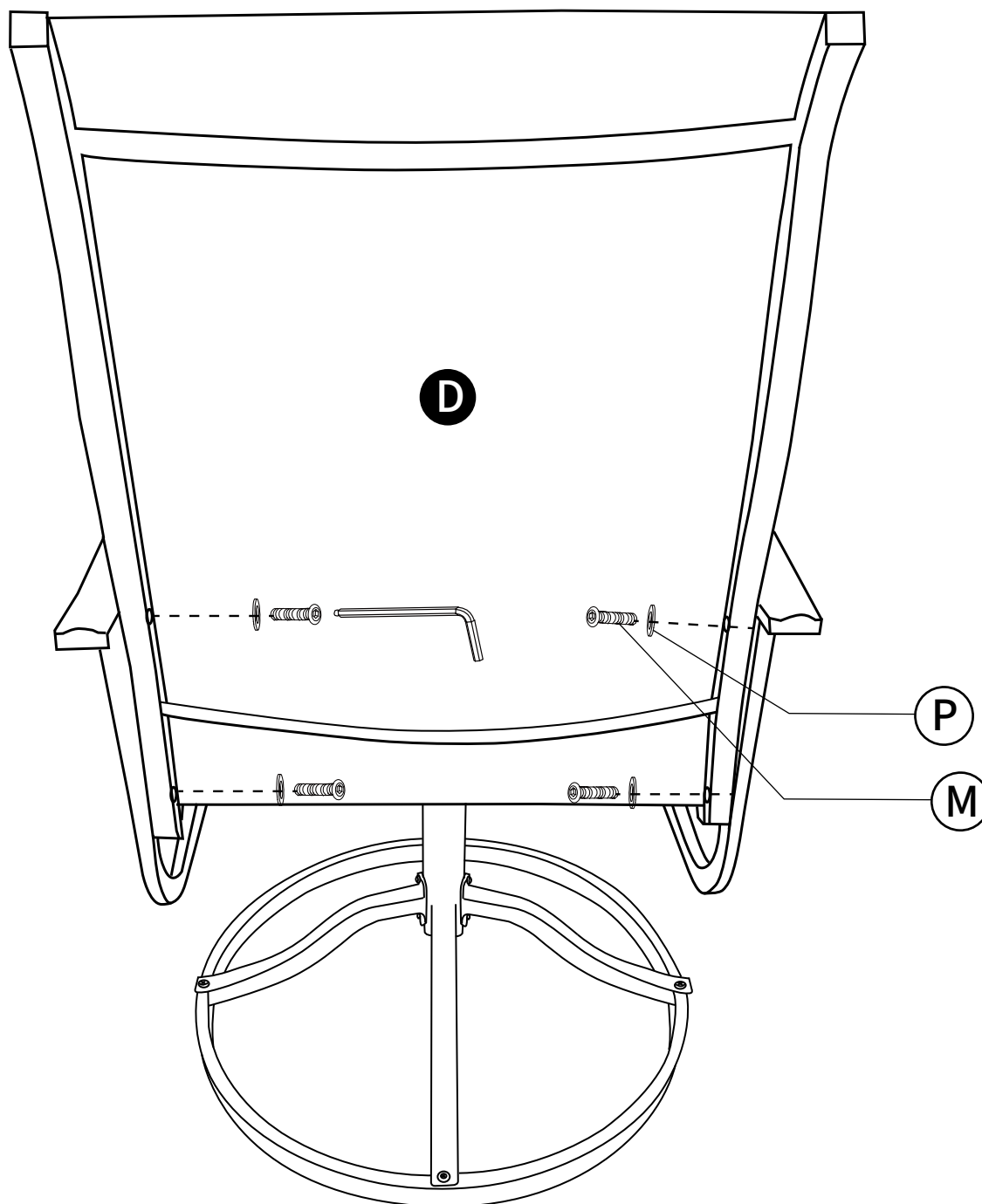

STEP 8

The chair is assembled and can be swivelled 360 degrees.

