

# LED Indoor Luminaires Ceiling Mount – Pendant 120VAC / 60Hz

## Safety Precautions

- Read all safety precautions and installation instructions carefully before installing or servicing this fixture. Failure to comply with these instructions could result in potentially fatal electric shock and/or property damage.
- It is recommended that a qualified electrician perform all wiring. This fixture must be wired in accordance with all national and local electrical codes.
- This fixture is designed for use in a 120VAC / 60Hz circuit. This fixture is compatible with a TRIAC (forward-phase or leading-edge) / ELV (reverse-phase or trailing-edge) dimmer.
- Make sure that the power source conforms to the requirements of the fixture. (See labels on the fixture housing).
- To reduce the risk of electrical shock, and to assure proper operation, this fixture must be adequately grounded. To accomplish proper grounding, there must be a separate ground wire (green) contact between this fixture and the ground connection of your main power supply panel.
- This fixture is intended to be used for general indoor lighting in dry or damp locations.
- Disclaimer

Changes or modifications not expressly approved by the party responsible for compliance could void the user's authority to operate the equipment. NOTE: This equipment has been tested and found to comply with the limits for a Class B digital device, pursuant to Part 15 of the FCC Rules and Canadian ICES-005 (B) / NMB-005 (B). These limits are designed to provide reasonable protection against harmful interference in a residential installation. This equipment generates, uses and can radiate radio frequency energy and, if not installed and used in accordance with the instructions, may cause harmful interference to radio communications. However, there is no guarantee that interference will not occur in a particular installation. If this equipment does cause harmful interference to radio or television reception, which can be determined by turning the equipment off and on, the user is encouraged to try to correct the interference by one or more of the following measures:

- Reorient or relocate the receiver antenna.
- Increase the separation between the equipment and receiver.
- Connect the equipment into an outlet on a circuit different from that to which the receiver is connected.
- Consult with the dealer or an experienced radio/TV technician for help.

Any modifications to this fixture may void the warranty and interfere with the safe operation of the luminaire.

Operation is subject to the following two conditions: (1) this device may not cause interference, and (2) this device must accept any interference, including interference that may cause undesired operation of the device.

## Assembly Instructions

### Step 1 – Preparing for installation

- A. **Disconnect electrical power** at fuse or circuit breaker box before installing or servicing any part of this fixture.
- B. Carefully remove the fixture and parts bag from the carton.
- C. Remove components from the parts bag.
- D. Remove mounting bracket (1) from the fixture (3) by removing two screws (2).
- E. Install mounting bracket (1) to the junction box (not included) using two screws (2) to secure it
- F. Fixture is provided with 108" adjustable cord (6). To raise fixture frame from the floor to desire height by loosening the strain relief set screws (5) counterclockwise part of the canopy (3) just enough for the cord to slide easily. Carefully push excess cord inside the canopy until desired length is achieved. Adjust the other cord to level the fixture frame. Re-tighten strain relief set screws (5) to secure cord. Note: excess can be coiled and twist tie to hide inside the canopy. This fixture is suitable for 65° max. slope ceiling.

### Wiring – All wiring must take place inside junction box (not included)

**Caution:** Make sure power is off at fuse or circuit breaker box. Check power wires for damage or scrapes. If power supply wires are within three inches of the LED driver, use wire suitable for at least 90°C (194°F).

**Note:** Most dwellings built before 1985 have supply wire rated to 60°C. Consult a qualified electrician to ensure correct branch circuit conductor before installing.

### Step 2 – Wiring fixture

- A. Make all wire connections to appropriate wire. Secure with wire nuts (provided).
- B. Connect the green wire from the fixture to the supply power source ground wire.
- C. **For none dimming fixture.** Connect the white wire from the fixture to the white (N) wire from supply power source. Connect the black wire from the fixture to the black (L) wire from supply power source.
- D. **For TRIAC dimming.** Connect the white wire from the fixture to corresponding neutral (N) wire in accordance with the dimmer manufacturer instructions. Connect the black wire from the fixture to the corresponding control line (L) wire in accordance with the dimmer manufacturer instructions.
- E. **Do not mix wires.** Pull on each wire lead to make sure connections are secure. Make certain no bare wires are exposed outside of wire connectors. Tuck all connections neatly into the junction box.

### Step 3 – Mounting

- A. Install the fixture (3) over the mounting bracket (1) by aligning side holes together then using two screws (4) to secure it.

### Step 4 – Restore power at fuse or circuit breaker box

View shown for reference only. Individual models may vary.

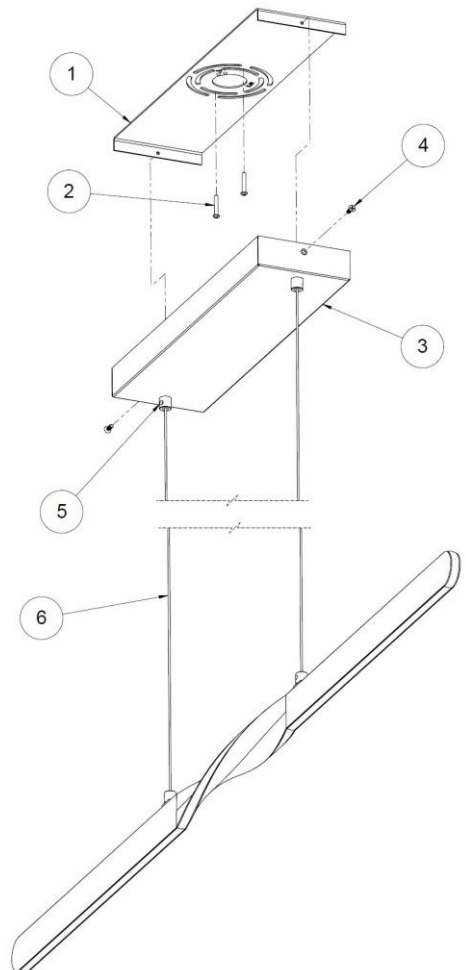

### Limited Factory Warranty

We hereby warrant that this fixture is free from defects in materials and workmanship when installed and used under normal operating conditions for a period of 5 years from date of purchase. This warranty covers all component parts and extends only to replacement of defective fixture or components; it does not cover failure due to improper installation, misuse, mishandling or damage incurred in transit.