

ASSEMBLY INSTRUCTION

Thank you purchasing the BED. Please read the Instructions carefully to ensure safe operation of the products.

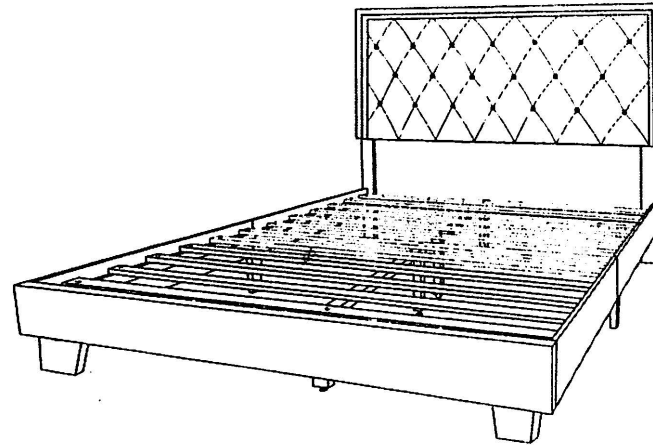

Colour : Velvet Grey, Black, Blue

PLEASE READ this sheet prior to assembly to familiarise yourself with the various stages of construction.

Carefully open the pack supplied and check the contents against the parts and fittings check list. Do not destroy any of the packaging until you are certain that you have all the necessary parts for the assembly.

CAUTION: There are small components used in the construction of this unit. These loose items should be kept away from young children whilst assembling your unit to avoid the danger of choking hazards.

Tools Required

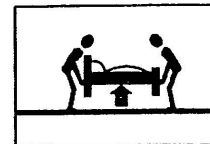

ASSEMBLY INSTRUCTIONS

IMPORTANT - READ CAREFULLY RETAIN THESE INSTRUCTIONS FOR FUTURE REFERENCE.

INFORMATION.

- This product is intended for a maximum person's weight of 130kg per side. Do not exceed this weight.
- Incorrect installation could lead to injury. take care following instructions.
- Due to the size of this product we recommend that it is assembled in the room intended for use.
- When you are ready to start, make sure that you have the right tools, plenty of space and clean, dry area for assembly.
- Unwrap all packaging materials and place the components on top of the carton box or on a clean floor to prevent it from scratching.
- Check the pack and make sure you have all the parts listed.
- Ensure that this product is fully assembled and secured as illustrated before use.
- Check all screws or bolts are tightened and inspect regularly.
- This product should only be used on firm, level ground.
- Dismantle for transportation.
- Only use recommended accessories.
- Tools are not included.

WARNINGS

- DO make sure the legs remain in contact with the ground.
- DO keep small parts out of reach of children.
- DO NOT use power tools to construct this product.
- DO NOT tighten screws until fully assembled.
- DO NOT over tighten screw or bolts.
- DO NOT use this product if parts are missing, damaged or worn.
- DO NOT stand on the product.

CARE INFORMATION

- Never use scourers, abrasives or chemical cleaners.
- To clean wipe with a sponge and warm soapy water. Do not use solvent based cleaners or detergents as they can bleach or damage the product.

**ASSEMBLY
COMPLETE**

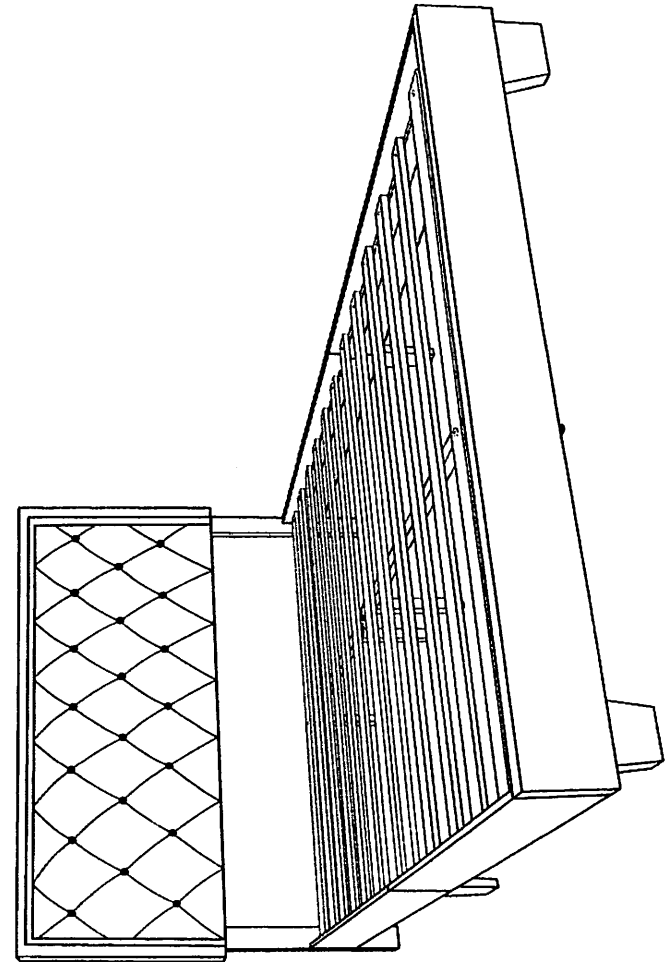

ASSEMBLY INSTRUCTIONS

STEP 5

PART REQUIRED

1. Footboard - 1 pc
2. Footboard Leg - 2 pcs
3. Wood Dowel - 4 pcs
4. JCBC M6 x 70mm - 2 pcs

2X

STEP 7

PART REQUIRED

1. Bed Slat - 10 pcs
2. Center Support Rail - 4 pcs
3. Center Support Leg - 4 pcs
4. JCBC M6 x 60mm - 4 pcs
5. Adjuster M6 - 4 pcs

4X

STEP 6

PART REQUIRED

1. Side Rail - 4 pcs
2. Footboard - 1 pc
3. Headboard - 1 pc
4. JCBB M8 x 20mm - 4 pcs

4X

STEP 8

PART REQUIRED











1. Bed Slat - 10 pcs
2. CSK M4 x 32mm - 20

ASSEMBLY INSTRUCTIONS

PARTS LIST

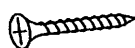
1.		2.		3.	
	HEADBOARD Qty: 1 PC		FOOTBOARD Qty: 1 PC		SIDE RAIL (LEFT & RIGHT) Qty: 4 PCS
4.		5.		6.	
	HEADBOARD LEG (L&R) Qty: 2 PCS		FOOTBOARD LEG Qty: 2 PCS		SIDE RAIL SUPPORT LEG Qty: 2 PCS
7.		8.		9.	
	SIDE RAIL SUPPORT RAIL Qty: 4 PCS		CENTRE SUPPORT LEG Qty: 4 PCS		SMALL SUPPORT CUBE Qty: 8 PCS
10.		11.			
	CENTER SUPPORT RAIL Qty: 2 PCS		BED SLAT Qty: 10 PCS		

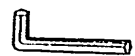
HARDWARE LIST

A		JCBB M8 X 20MM	8 PCS
B		JCBC M6 X 70MM	2 PCS
C		JCBC M6 X 60MM	4 PCS
D		JCBC M6 X 45MM	6 PCS
E		JCBC M6 X 25MM	8 PCS
F		FLAT WASHER M6	14 PCS
G		SPRING WASHER M6	14 PCS
H		CSK M4 X 32MM	36 PCS
I		WOOD DOWEL M8	4 PCS
J		ALLEN KEY M4	1 PC
K		ALLEN KEY M5	1 PC
L		ADJUSTER M6	4 PCS

ASSEMBLY INSTRUCTIONS

