



# Installation Information

**CALWT60X36RSB**



# Installation Steps

This product must be installed by a qualified plumber. It is the installer's responsibility to ensure a proper installation, trouble-free water evacuation, and overall watertightness.

1. Attach the drain to the drain outlet. When installing the drain, apply sealant to the two side flanges of the drain to prevent leaks and then use a wrench to tighten the drain screws.
2. Once the screws are properly tightened, check for any signs of leakage around the flanges. If the sealant has been applied correctly and the screws are tightened properly, there should be no leakage.
3. Next, install the trap, which is a curved pipe that collects and holds water to prevent sewer gas from entering the room. Slide the trap onto the drain outlet and attach it using the provided clips or screws.

Make sure the trap is properly aligned and securely attached to prevent any leaks or movement.

4. After installing the trap, test the drain by pouring water into it to ensure that it drains properly and there are no leaks. If everything is working correctly, you can now proceed to install any additional fixtures or accessories, such as a sink or a laundry tub, onto the drain.

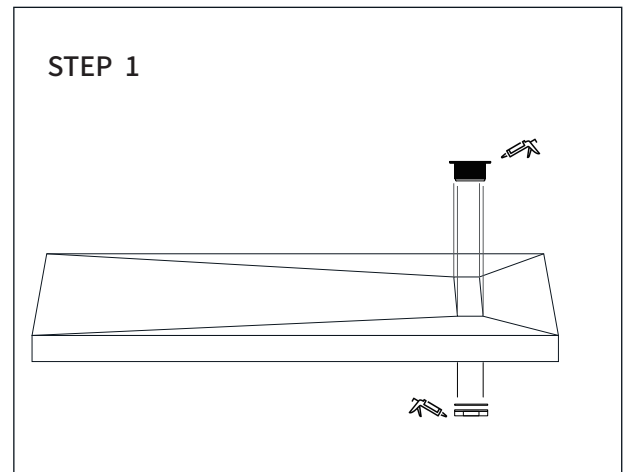

In order to properly install the drain pipe into the position of the bottom drain outlet, follow these steps.

1. Locate the bottom drain outlet and mark its position.
2. Position the drain pipe so that it is aligned with the outlet.
3. Use a wrench or pipe wrench to tighten the nut on the drain pipe, ensuring it is securely in place.
4. Check for any leaks by pouring water into the pipe and inspecting for any signs of leakage.
5. Once the installation is complete, clean up any excess materials and test the system to ensure it is functioning properly.

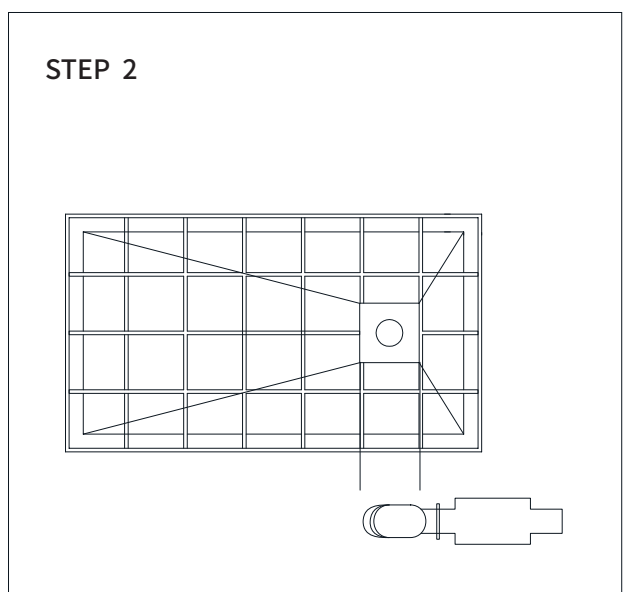

To ensure the successful installation of a shower tray, it is crucial to properly align the drainage pipes and confirm their position in the drain. Here are the steps to follow.

1. Confirm the Position of the Drain: Firstly, ensure that the drain is positioned correctly in the designated area. The drain should be level and centered, with no tilting or skewing. This will ensure that water drains efficiently and does not pool in one area.

2. Alignment of the Drainage Pipes: When installing the shower tray, it is essential to align the drainage pipes correctly. Use a level to ensure that the pipes are straight and parallel to each other. If the pipes are not aligned correctly, water may not drain properly, leading to leaks or flooding.

3. Check for Clearance: After aligning the pipes, check for any obstacles or obstructions that may prevent a smooth flow of water through the drain.

Make sure that there are no clumps of hair, soap scum, or other debris that could block the flow of water.

STEP 3

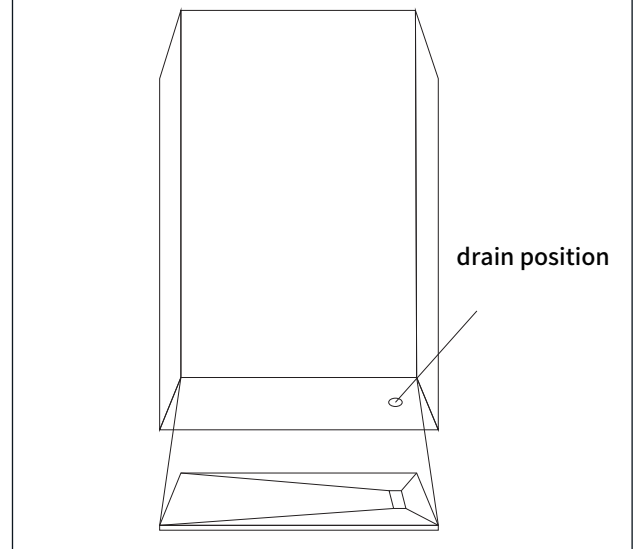

To prevent leaks, use a glue gun to carefully apply sealant along the red edges. Before operation, the applicator is heated to the optimal temperature, which is usually indicated on the machine. Once the applicator is ready, squeeze out a small amount of sealant and apply it to waste paper or cardboard to test its viscosity.

1. Apply the sealant in a continuous, even line along the entire red edge, ensuring that there are no gaps or overlaps. Use a steady hand and apply a moderate amount of pressure to ensure that the sealant is applied evenly. Avoid applying too much sealant, as this can create a build-up that can ultimately lead to leaks.

2. Once the sealant is applied, allow it to cure according to the manufacturer's instructions. This usually involves leaving it to dry for a certain period of time, which can vary depending on the type of sealant used.

3. Remember to clean up any excess sealant immediately with a damp cloth or solvent-based cleaner to maintain a professional finish.

STEP 4

