

NOTE:

This brochure contains IMPORTANT safety info. Please read and keep for future reference.

MAINTAINANCE AND WARNING

- 1.Keep furniture away from heat sources.
- 2.Do not clean furniture with harsh cleaner or polishes.Do not use detergents,solvents,abrasives,spray packs or leather cleaner. Use non-color mild soa with warm water to clean spills(Mix 1:10 soap to water).
- 3.Do not place furniture under direct sunlight,material will possibly fade over time.
- 4.Do not use on site dry cleaning machine.Children should not climb or jump on the furniture.
- 5.Do not write on furniture that is not protectedby a padded barrier.
- 6.Not for commercial use,only for residential use.



Weight Limitation

80 LBS

EXPLOSIVE VIEW

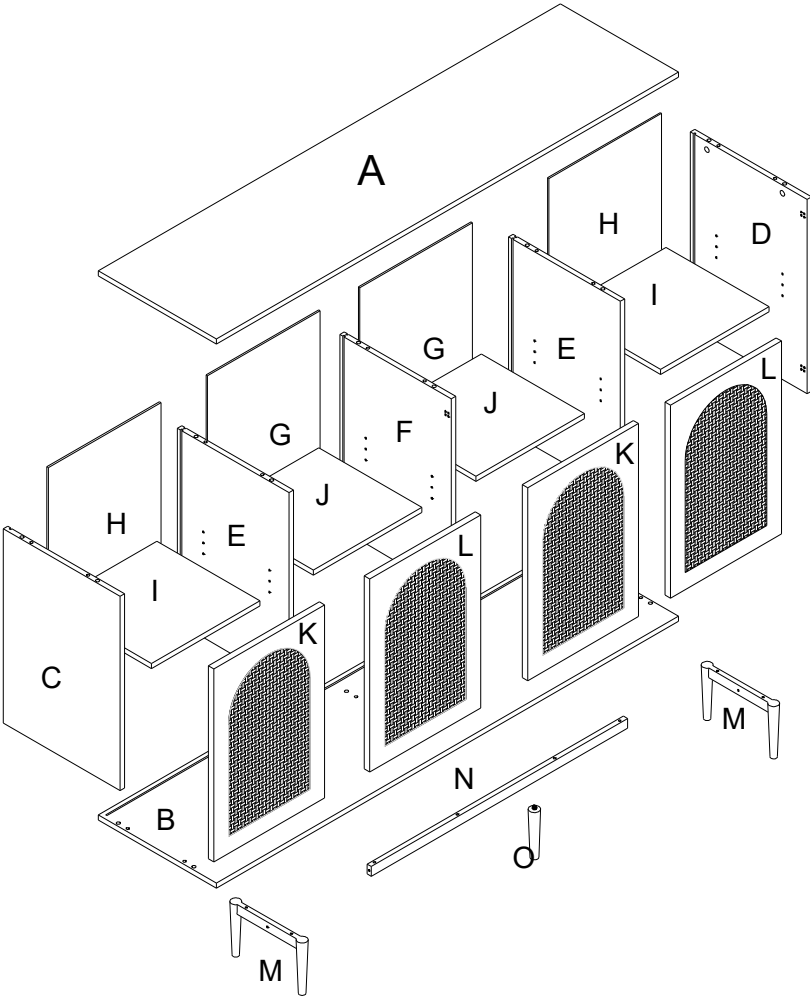







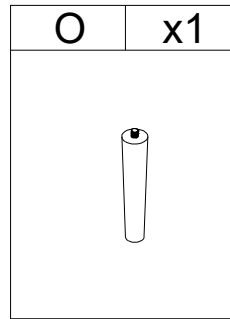
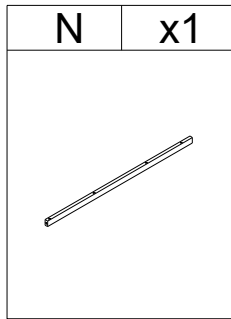
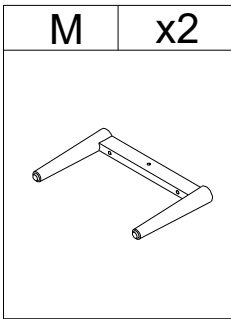
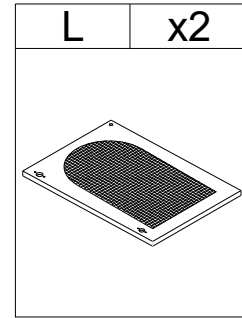
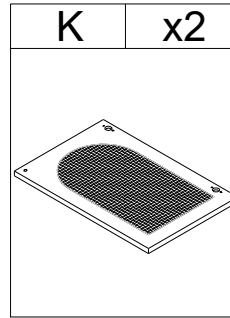
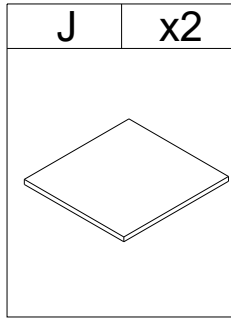
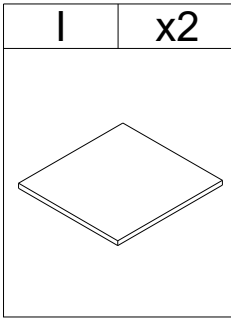
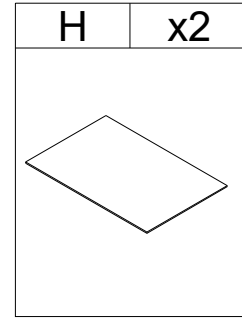
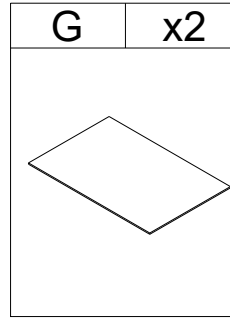
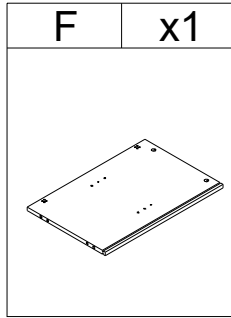
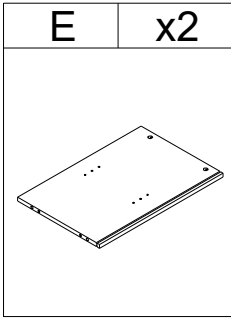
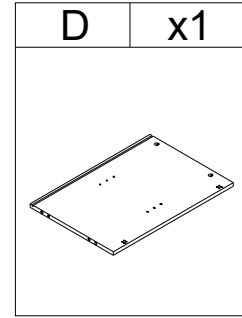
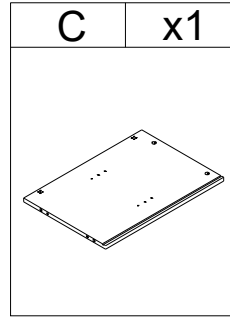
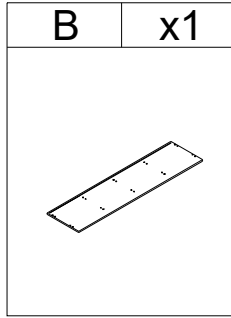
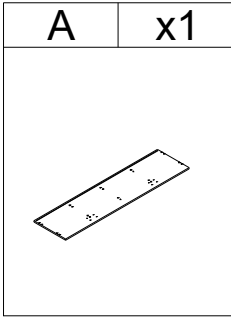





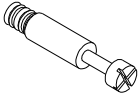

OVERVIEW

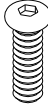



PARTS LIST

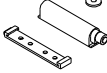

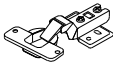



HARDWARE LIST

#1	x88	#2	x10	#3	x10	#4	x20	#5	x10	#6	x4
											
M3.5*14		M7*50		Ø6*35mm		Ø8*30mm		Ø15*11mm		M4*35	
#7	x8	#8	x2	#9	x16	#10	x24	#11	x4	#12	x2
											
M6*50		M6*40						8*30mm			
#13	x4	#16	x4	#17	x4	#18	x10	#19	x4		
											
						Ø20					

TOOL LIST

#14	x1	#15	x1
			
M4			

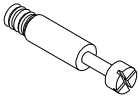
HARDWARE SPARE LIST

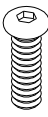
#1	x1	#2	x1	#3	x1	#7	x1	#8	x1
									
M3.5*14		M7*50		Ø6*35mm		M6*50		M6*40	

ASSEMBLY INSTRUCTIONS

STEP-1

1.Prepare for part A. Align the holes in part A, insert wooden dowel #3 .

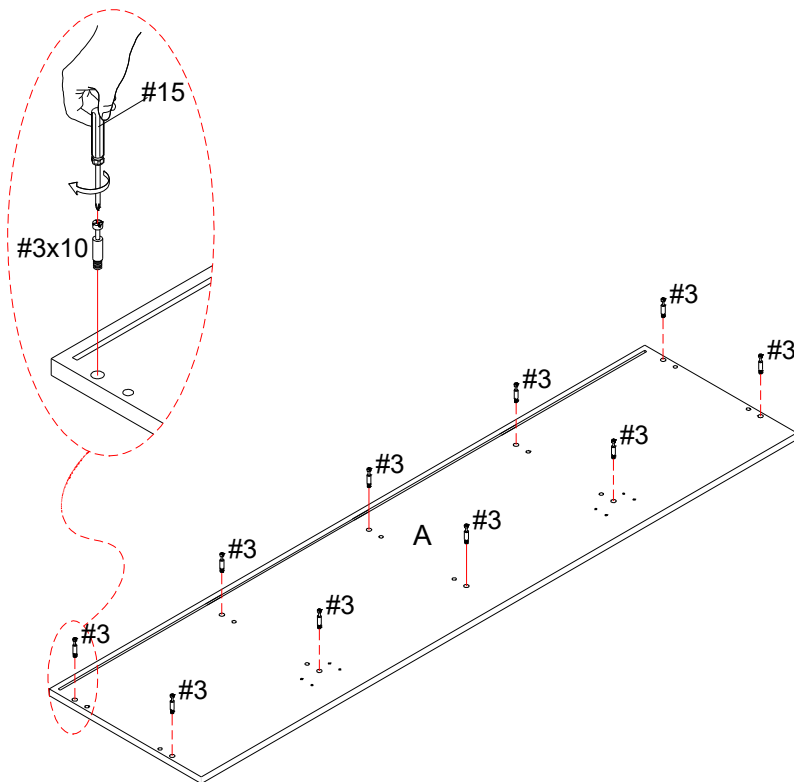

#15	x1
	

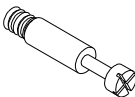
#3	x10
	
Ø6*35mm	

ASSEMBLY INSTRUCTIONS

STEP-2

1.Prepare for part A. Align the holes in part A, insert bolt #4 , and tighten bolt #4 with screwdriver #15.

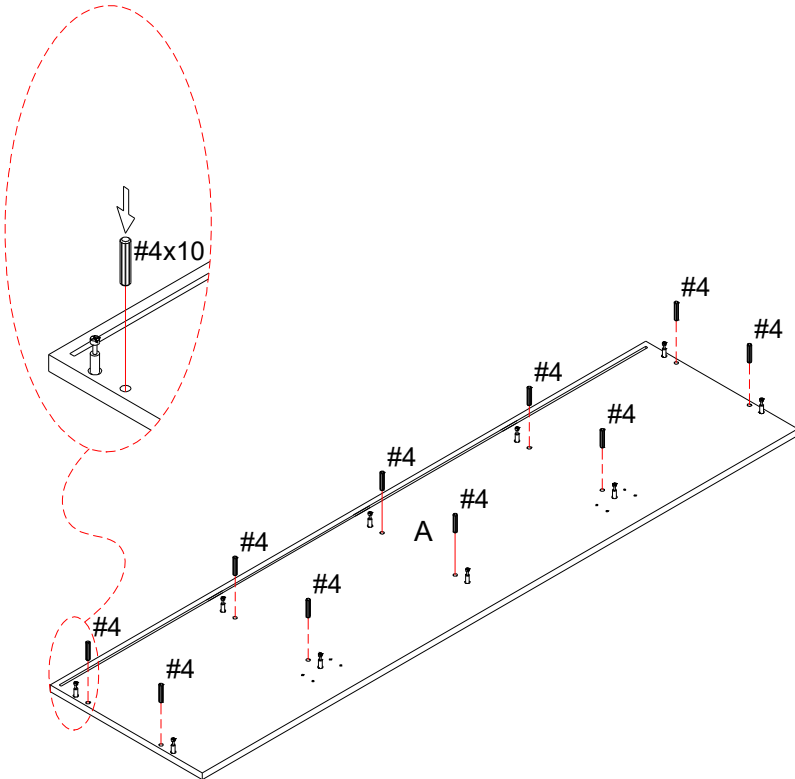

#4	x10
	
Ø8*30mm	

ASSEMBLY INSTRUCTIONS

STEP-3

1.picture shows.Use bolt #1 to attach rebound parts #16 to panel, tighten bolts with screwdriver #15.

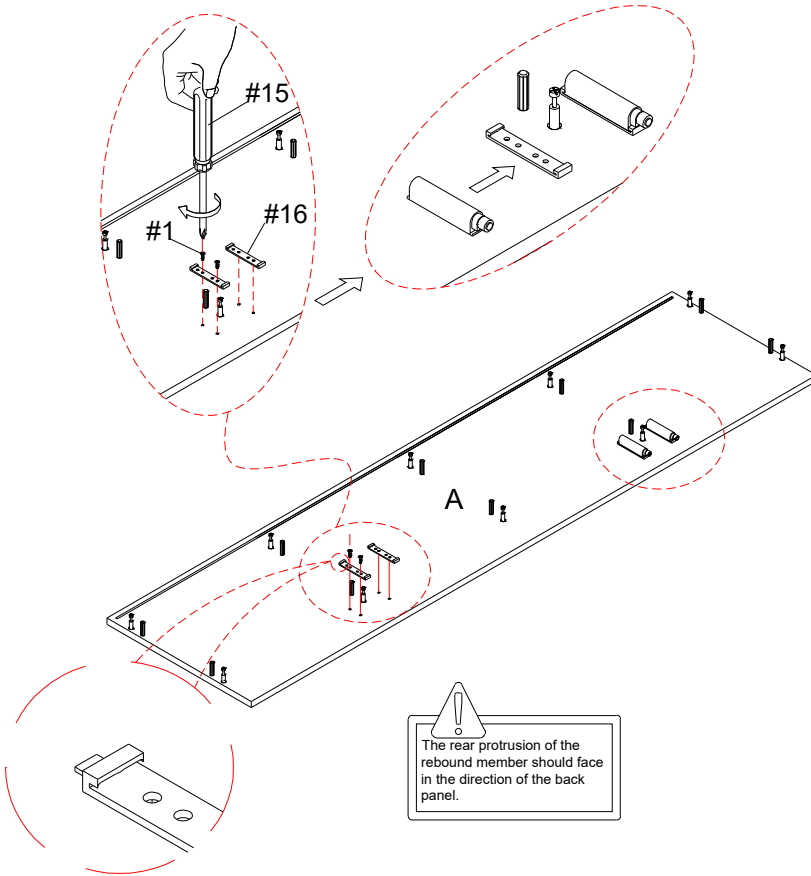



#16	x4	#1	x8	#15	x1
		M3.5*14			

ASSEMBLY INSTRUCTIONS

STEP-4

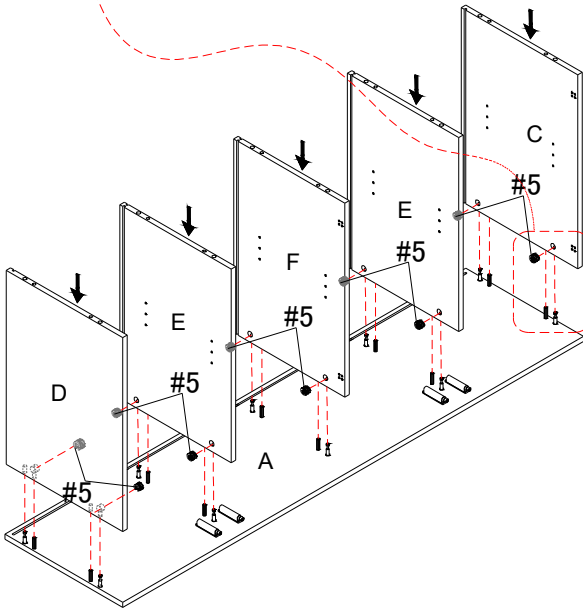
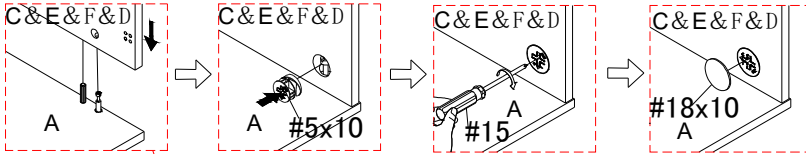
1. Connect the part A with part (C,D,E,E,F). align the hole in the part (C,D,E,E,F),insert the bolt #3 and wooden dowel #4 in part A into part(C,D,E,F).and tighten the nuts#5 with a screwdriver#15.cover #18 the screw hole afte installation is finished. Make sure the groove is in same side as picture show.



#15	x1
	

#5	x10
	
Ø15*11mm	

#18	x10
	
Ø20	

ASSEMBLY INSTRUCTIONS

STEP-5

1. slide in the part (H,G,G,H) into the groove in part C,E and E,F and F,E and E,D. make sure they are also in groove in part A.

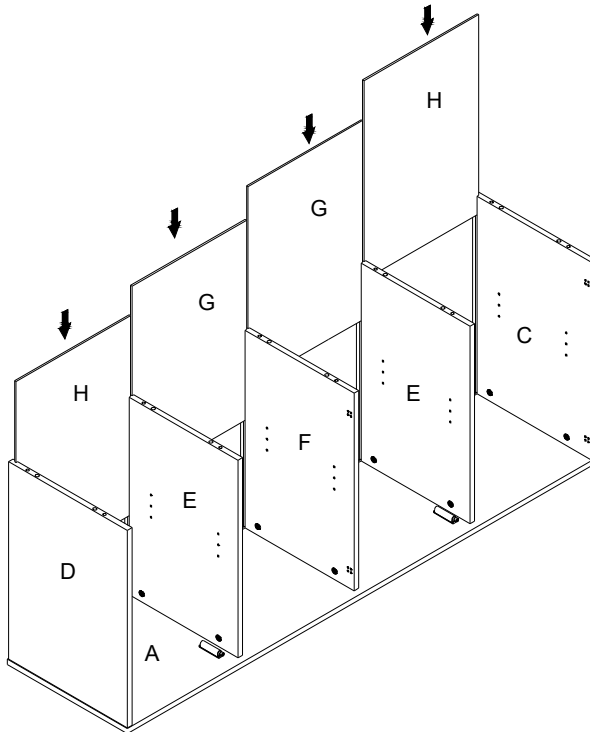

ASSEMBLY INSTRUCTIONS

STEP-7

1. Connect the part B the pre-assembled unit in step 6. Then align the holes in part B, Insert screw #2 Insert the wooden pin #4 into (C,D,E,F), by hand and push it down so that it connects to parts C,D,E,F,E. Next, and tighten the screw #2 with an Allen key #14.

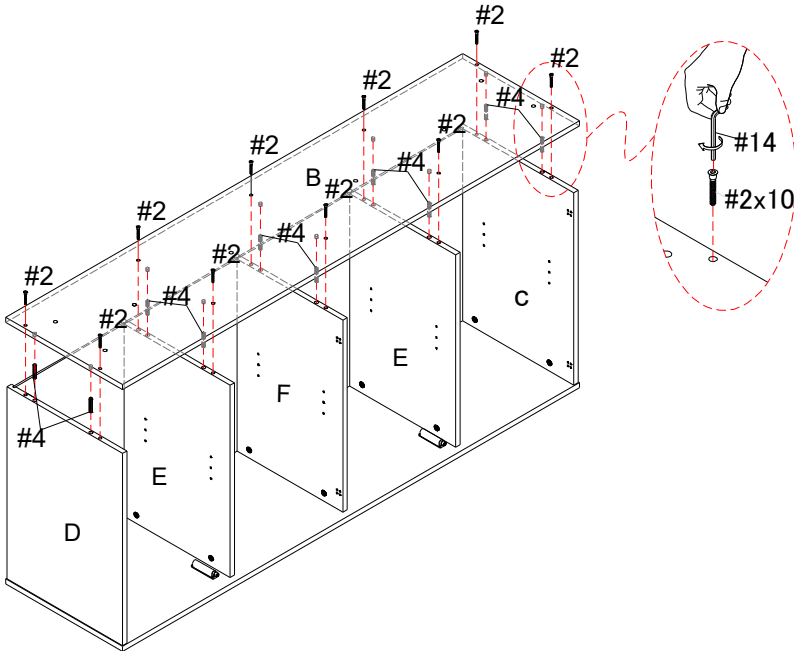

#4	x10
Ø8*30mm	

#2	x10
M7*50	

#14	x1
M4	

ASSEMBLY INSTRUCTIONS

STEP-8

1. Prepare the leg racks. Align the holes of the M part with the holes of the N part, install the screw #8, and tighten the screw #8 with the allen key #14.

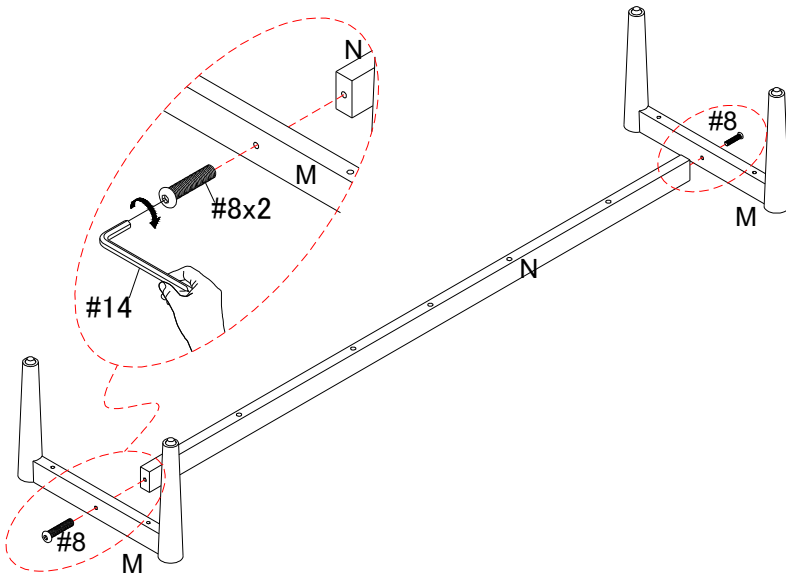

#8	x2
	
M6*40	

#14	x1
	
M4	

ASSEMBLY INSTRUCTIONS

STEP-9

1. connect the leg frame to the cabinet. Attach the leg frame to the pre-assembled unit in step 7 with a screw #7 and tighten with a allen key #14.

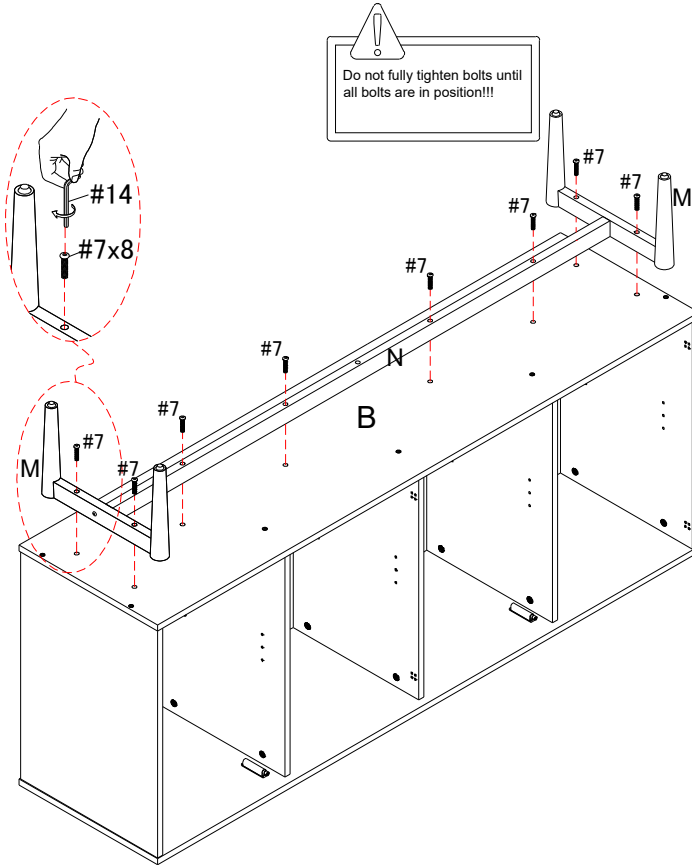

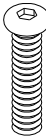
#7	x8
	
M6*50	

#14	x1
	
M4	

ASSEMBLY INSTRUCTIONS

STEP-10

1. connect the middle leg to the cabinet. Attach the middle leg to the pre-assembled unit in step 9 and hand tighten.

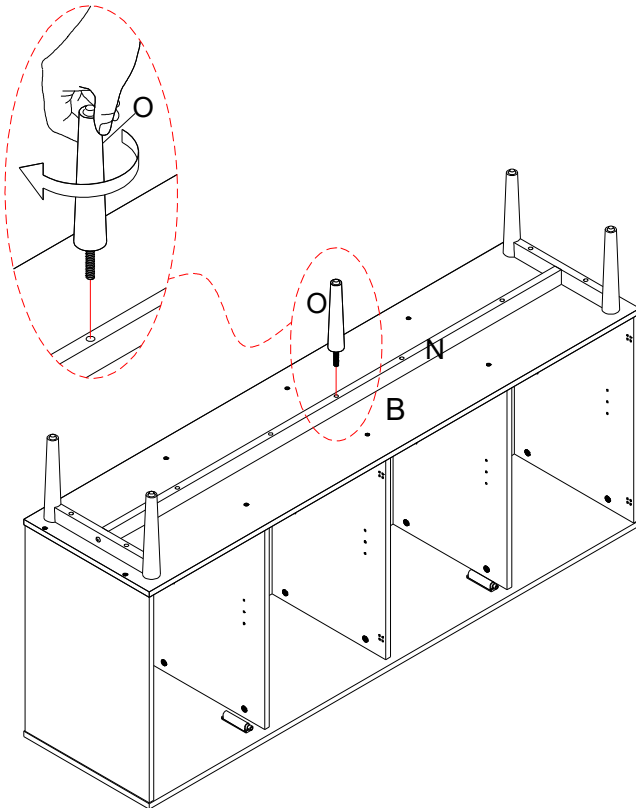



ASSEMBLY INSTRUCTIONS

STEP-11

1. Insert shelf pin#9 into reassemble unit at step 10. attach adjustable shelf (I,J,J,I) to pin #9

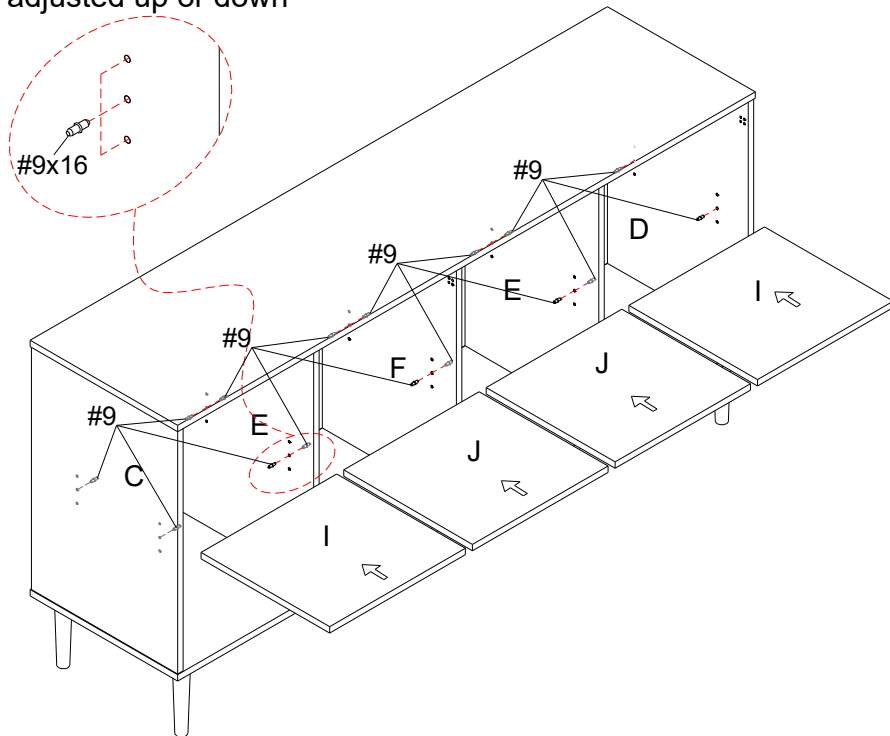
Shelf holder can be adjusted up or down







#9	x16
	

ASSEMBLY INSTRUCTIONS

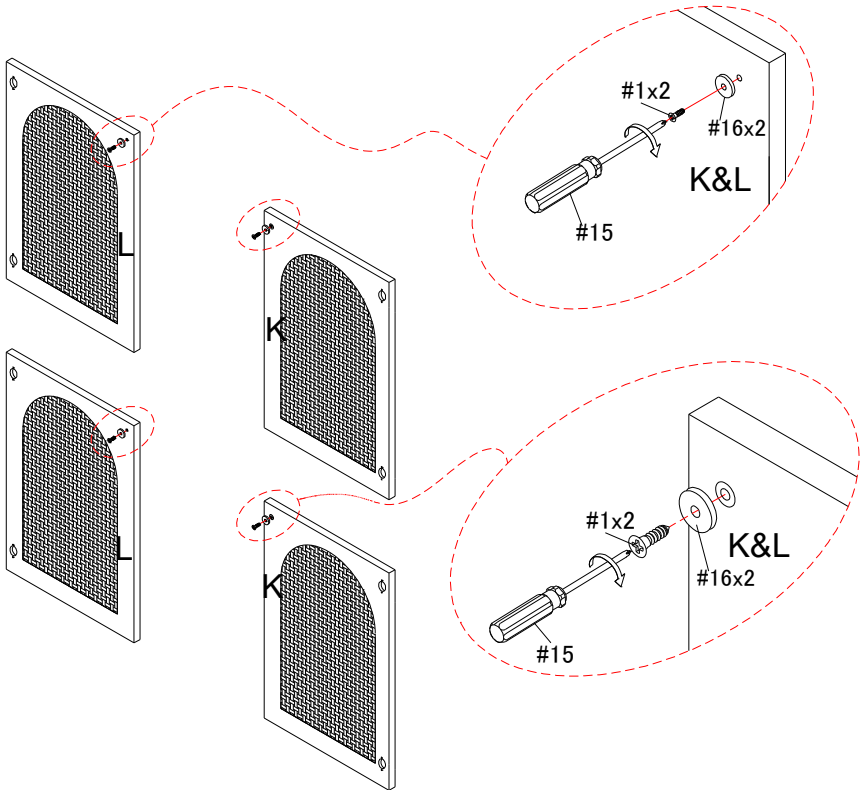
STEP-12

1. Use screw #1 to attach the gasket #16 to door panel (L)&(K) tighten screws with screwdriver #15.

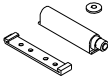

#15	x1	#16	x4	#1	x4
					
				M3.5*14	

ASSEMBLY INSTRUCTIONS

STEP-13

1. Use screw #1 to attach the hinges #19 to door panel (K)&(L), tighten screws with screwdriver #15.

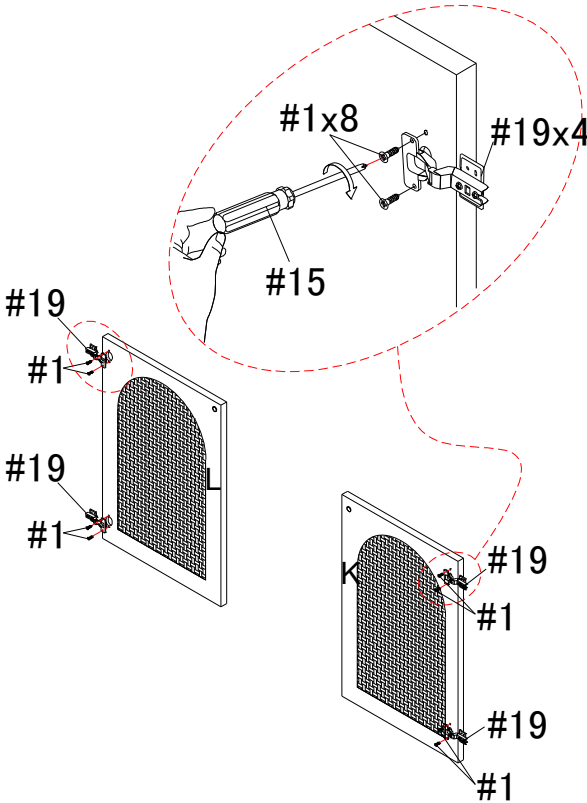

When installing hinge, please pay attention to distinguish the category of hinge

#15	x1
	

#1	x8
	
M3.5*14	

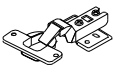

#19	x4
	

ASSEMBLY INSTRUCTIONS

STEP-14

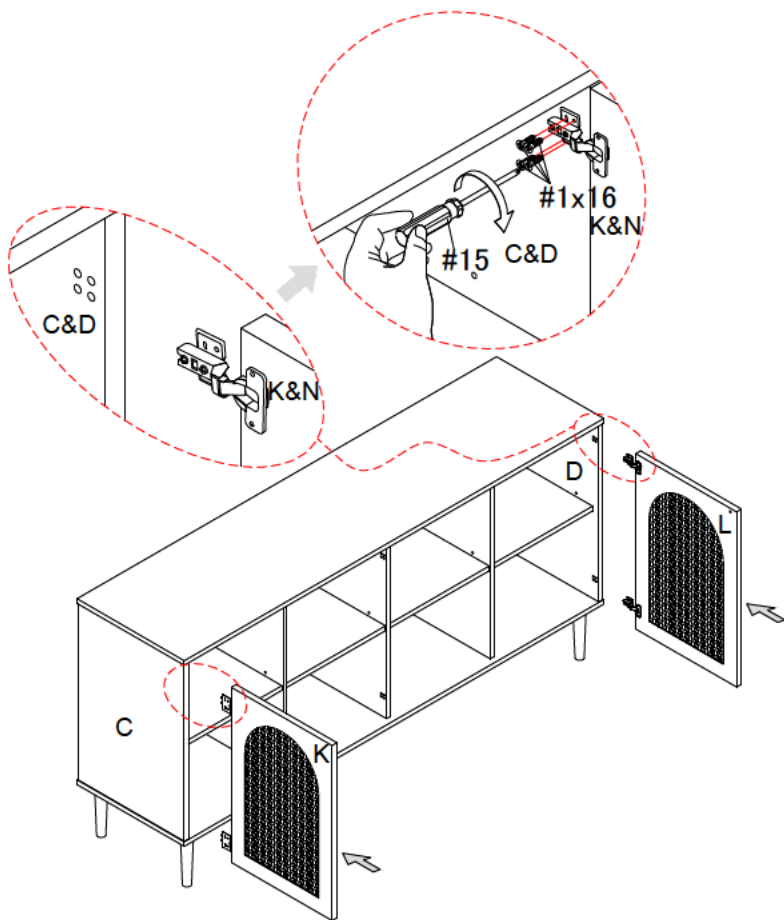
1. Use screw #1 to attach left (K) and right door (L) to reassemble unit at step 11 ,tighten screw with screwdriver #15 .



#15	x1	#1	x16
			
		M3.5*14	

ASSEMBLY INSTRUCTIONS

STEP-15

1. Use screw #1 to attach the hinges#17 to door panel (L)&(K)tighten screws with screwdriver #15.

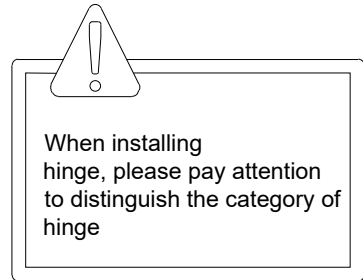
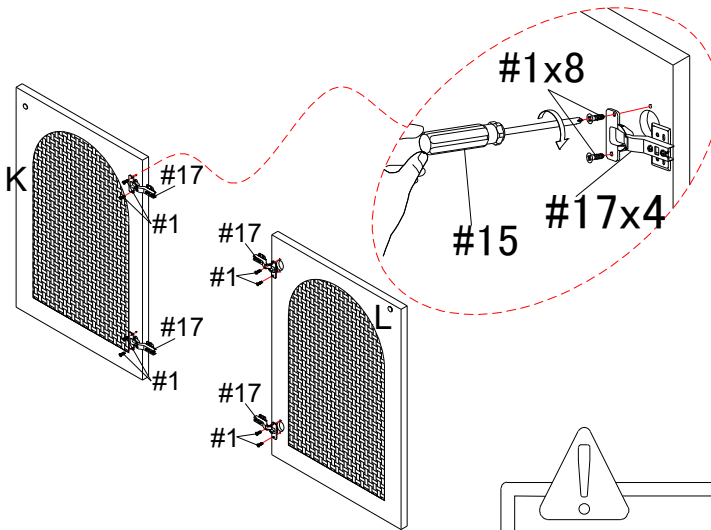



#17	x4	#15	x1	#1	x8
				M3.5*14	

ASSEMBLY INSTRUCTIONS

STEP-16

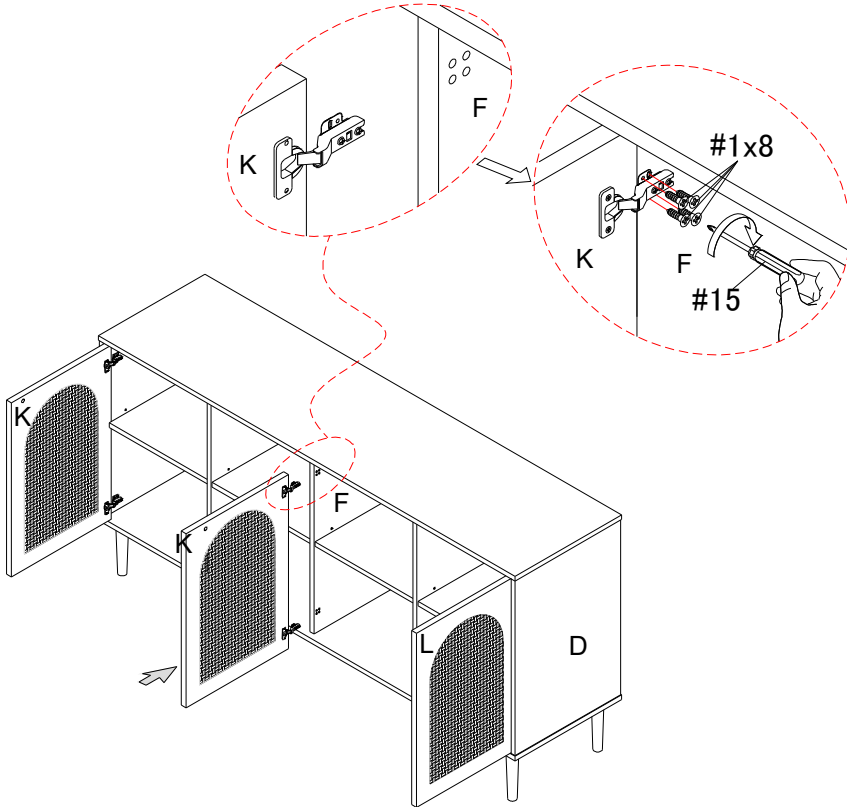
1. Use screw #1 to attach middle door (K) to reassemble unit at step 14 ,tighten screw with screwdriver #15 .





#15	x1	#1	x8
			
		M3.5*14	

ASSEMBLY INSTRUCTIONS

STEP-17

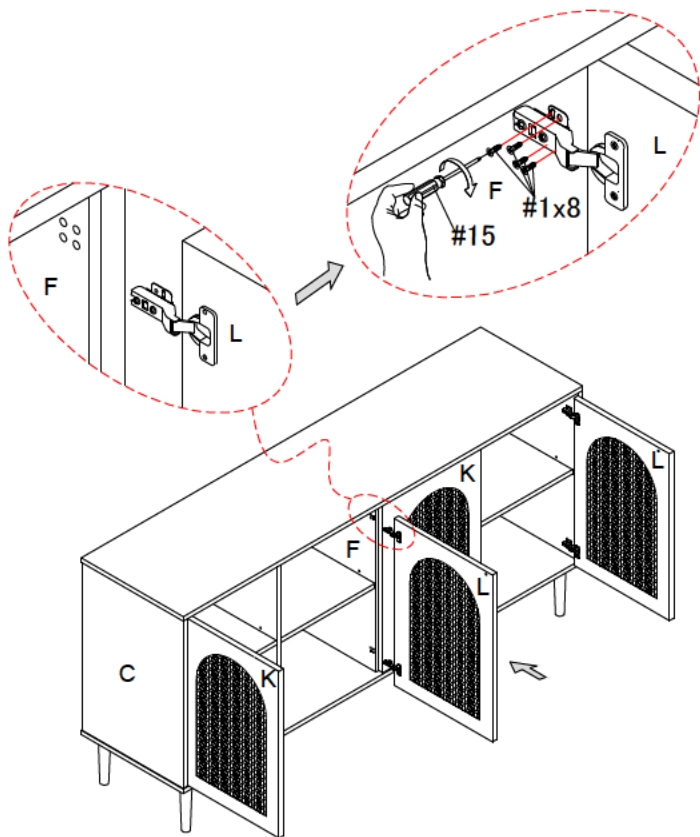
1. Use screw #1 to attach middle door(L) to reassemble unit at step 16 ,tighten screw with screwdriver #15 .



#15	x1
	

#1	x8
	
M3.5*14	

ASSEMBLY INSTRUCTIONS

Concealed hinges are three-way adjustable:

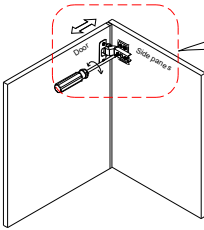

Horizontal
by screw adjustment!

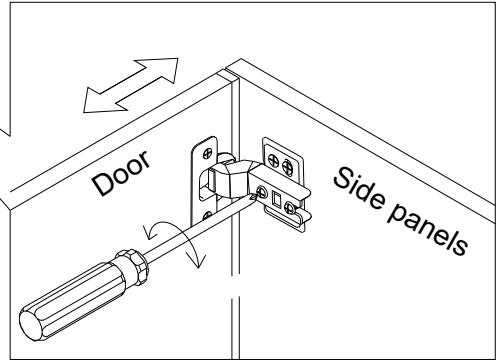

Concealed hinges are three-way adjustable:

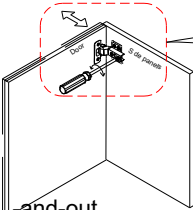

In-and-out
by loosening the hinge arm
mounting screw or via cam
adjustment!

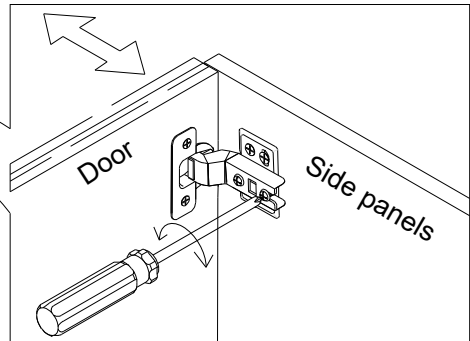

Concealed hinges are three-way adjustable:

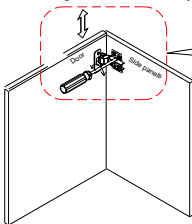

Vertical via slots
in the mounting plate
or via cam adjustment!

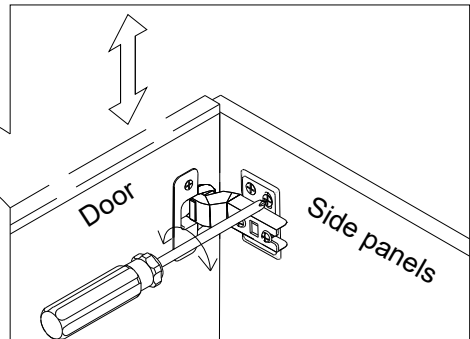

Hinge adjustment method

ASSEMBLY INSTRUCTIONS

STEP-18

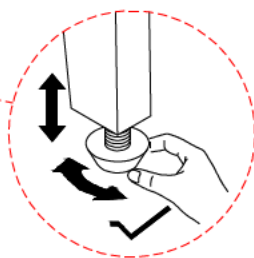
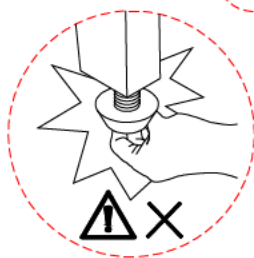
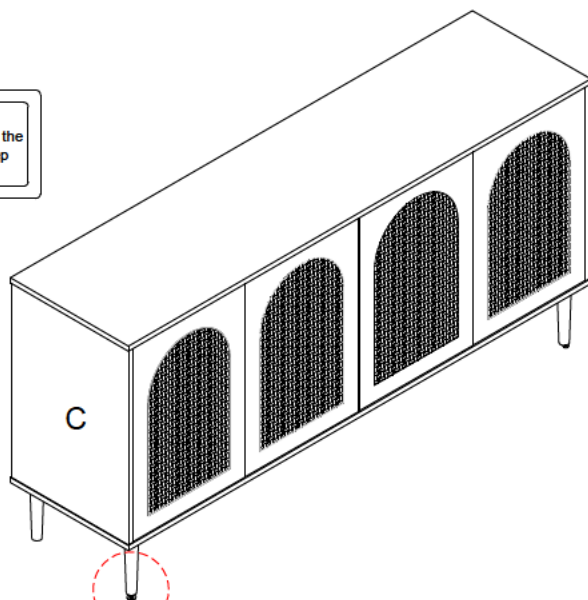
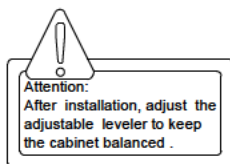



ASSEMBLY INSTRUCTIONS



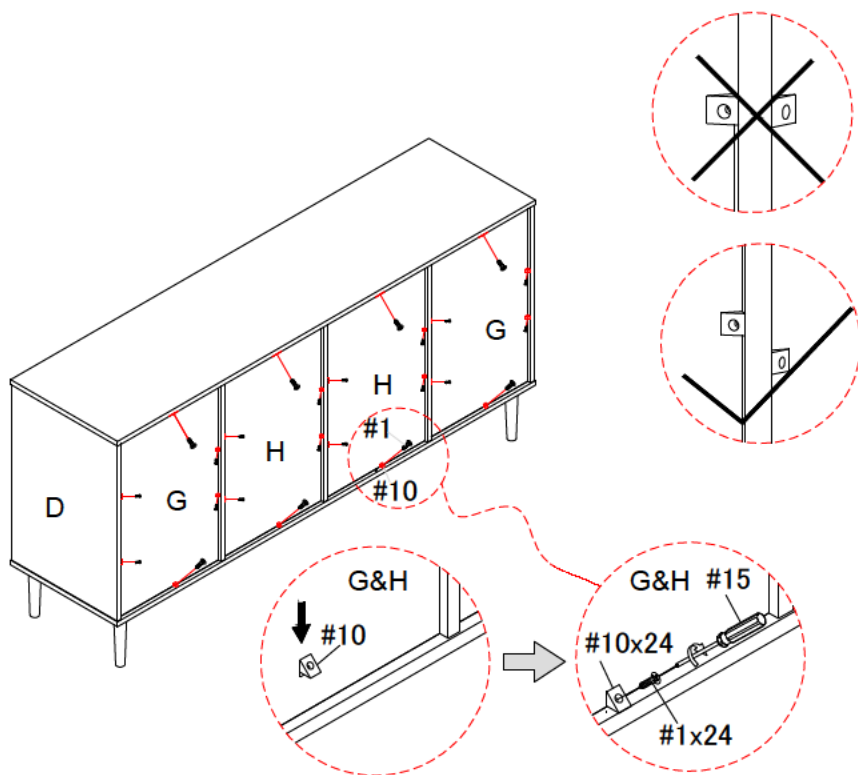

STEP-19

1. Attach part #10 to parts G,H,H,G with bolt #1 and tighten the bolt with screwdriver #15.

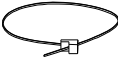

#10	x24	#15	x1	#1	x24
					
M3.5*14					

ASSEMBLY INSTRUCTIONS

#1	x4	#13	x4	#11	x4	#12	x2	#6	x4	#15	x1
											
M3.5*14				8*30mm				M4*35			

STEP-20

1. Attach part #13 to parts D, C with bolt #1 and tighten the bolt with screwdriver #15. Mark the position on the wall, that corresponds to the location of part #13 on the side panel D,C; Drill and insert the expandable screw #11 by hammer. Assemble the part #13 to the wall. Align the hole in the part #13 with the expandable screw #11, use screw #6 to attach it and tighten by screwdriver #15. Let the plastic belt #12 pass through the both part #13 and pull tightly.

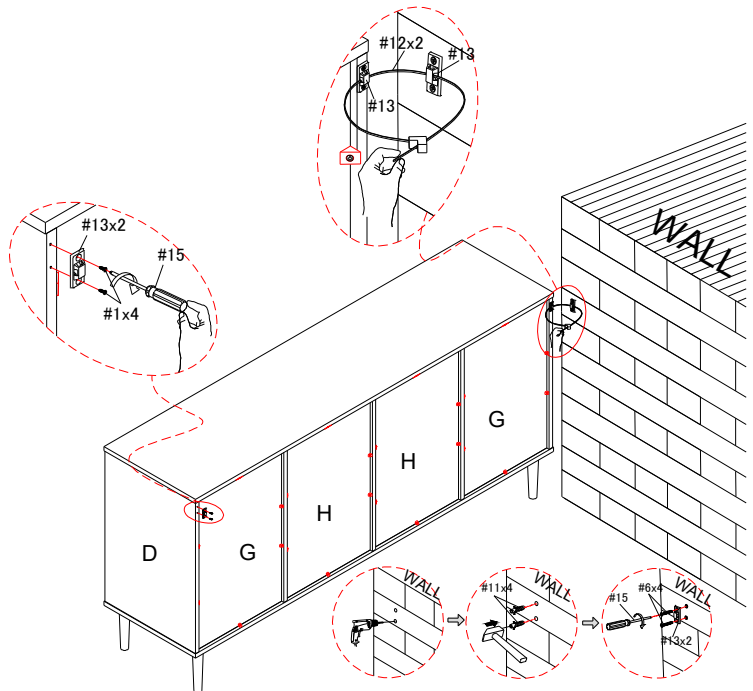

WARRANTY

1. We strive to offer high-quality products, and we also try our best to satisfy each and every customer that orders from us with product or service as needed.
2. We provide 30 days warranty starting from the time you receive the item. Each customer must provide a record of their order such as the order number, or item receipt for any items that are out of the warranty period you may also still receive.
3. Replacement parts by purchasing them with our company if they are available.