

WINGBACK HEADBOARD ASSEMBLY

COMPONENTS

ITEM	DESCRIPTION	QTY
A	Headboard	1
B	Headboard Leg	2
C	Wing	2

Please note: actual headboard may look different than illustration.

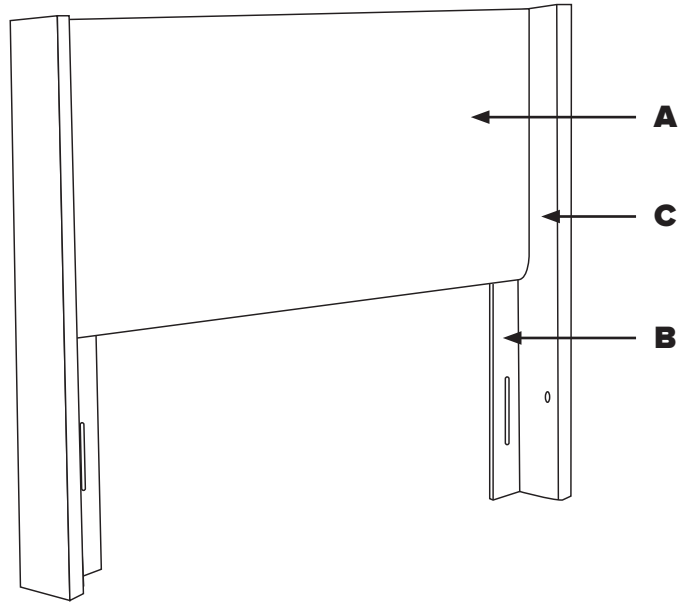

HARDWARE



(H1) x 8
2" x 5/16" bolt



(H2) x 26
1 1/4" washer



(H3) x 4
5/8" x 5/16" bolt



(H4) x 4
1 x 1/4" bolt



(H5) x 4
1/4" nuts

Please note: you will need a flat head screwdriver and a wrench to assemble your headboard.

LIMITED WARRANTY

We guarantee our upholstered furniture against defects in construction for a period of one (1) year. When a structural defect is brought to our attention, we will repair or replace it at our option at no charge to the customer (includes parts and labor, not transportation costs). Fabric wearability for upholstered furniture is not covered by the warranty. Vacuum for regular cleaning.

PLEASE DISPOSE OF PLASTIC BAG(S) AND CARTON(S) RESPONSIBLY.

WINGBACK HEADBOARD ASSEMBLY

STEP 1 - ATTACHING THE WINGS

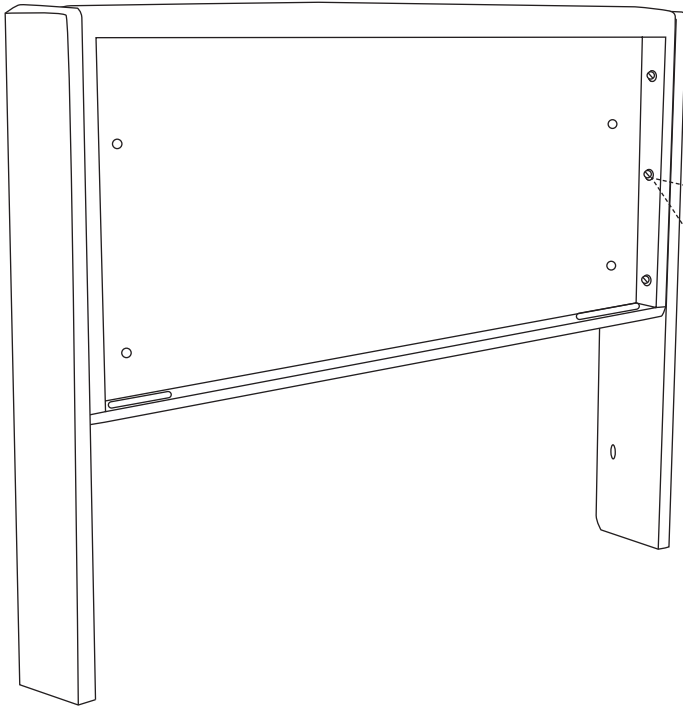

1.1

Attach (C) wing to (A) headboard using (H1) bolts and (H2) washer. Tighten using flat head screwdriver.

Please note: Make sure the top of the (A) headboard is level with the top of the (C) wings before tightening.

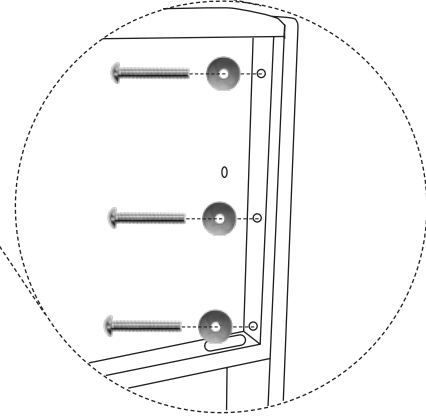

STEP 2 - ATTACHING THE HEADBOARD LEGS

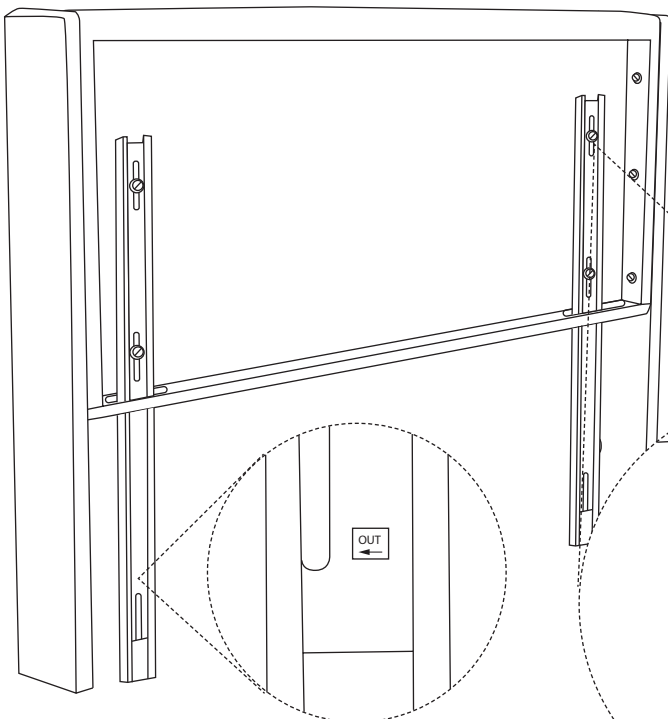

2.1

Insert (B) headboard leg through hole of (A) headboard and align the slots with the holes.

Please note: Make sure the "Out" sticker on each (B) headboard leg is facing the correct way.

2.2

Attach (B) headboard legs to (A) headboard using (H3) bolts and (H2) washers. Tighten with a flat head screwdriver.

Please note: Make sure the (B) headboard legs are flush with the ground before tightening.

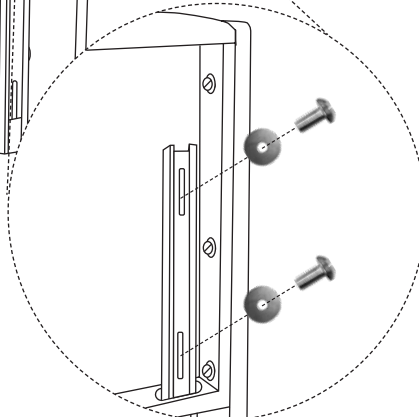
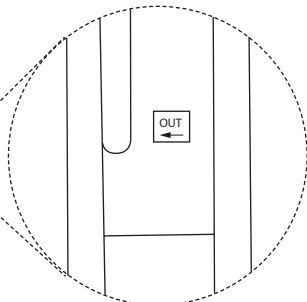

WINGBACK HEADBOARD ASSEMBLY

STEP 3 - ATTACHING ASSEMBLED HEADBOARD TO BED FRAME

3.1

Attach assembled headboard to your bed frame using (H4) bolts, (H2) washers and (H5) nuts. Tighten with a flat head screwdriver and wrench.

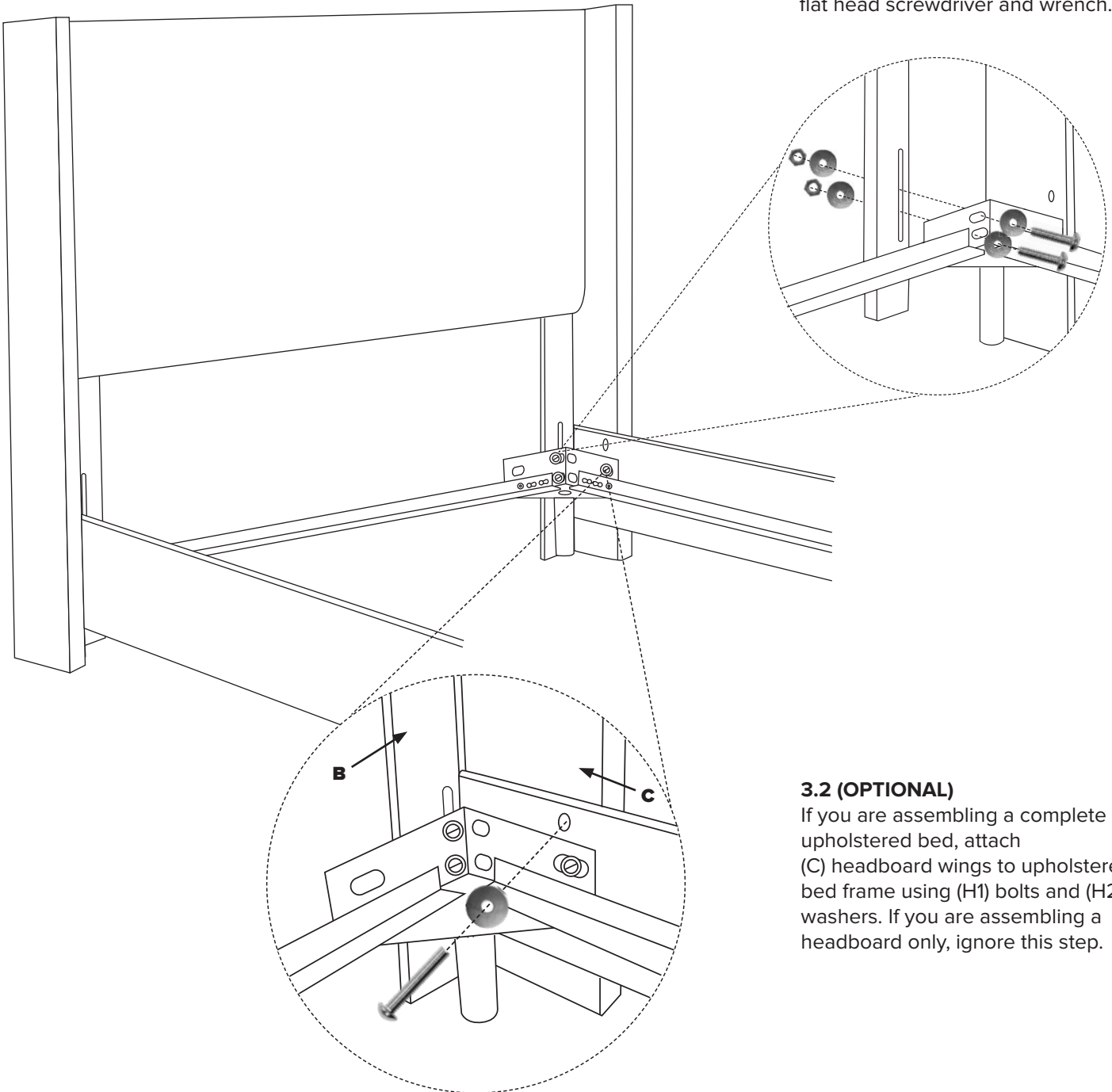

3.2 (OPTIONAL)

If you are assembling a complete upholstered bed, attach (C) headboard wings to upholstered bed frame using (H1) bolts and (H2) washers. If you are assembling a headboard only, ignore this step.