

ASSEMBLY INSTRUCTIONS

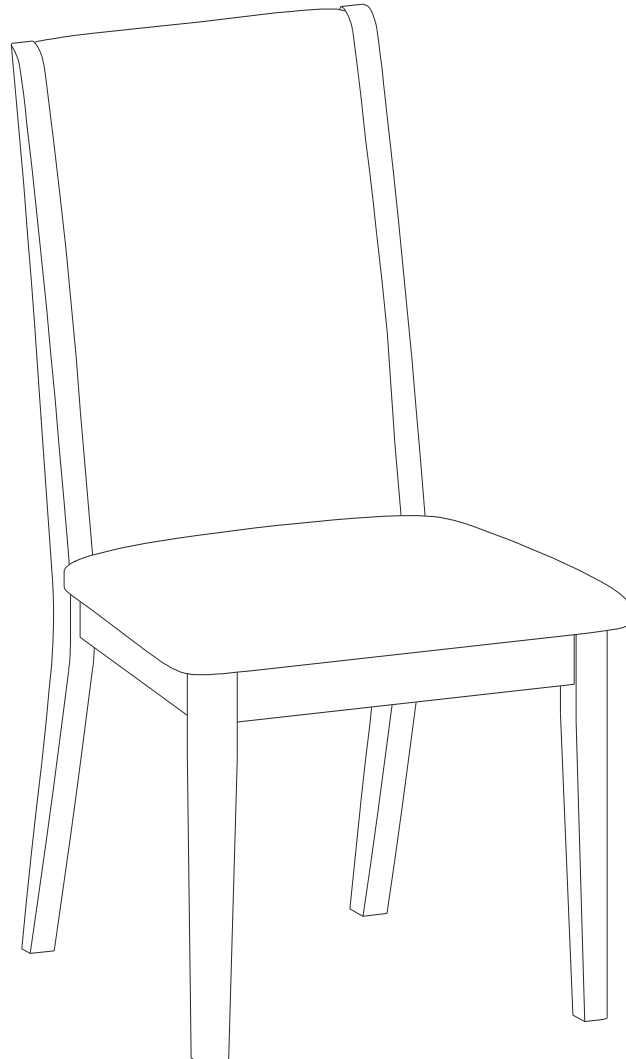

Description: DINING CHAIR Product

Dimension: 20"Wx22"Dx39"H

Cube Size : 40.9"x18.2"x14.9"

NW: 30.8 LBS

GW: 37.4 LBS

BEFORE ASSEMBLY

Thank you for purchasing our product. This product has been designed for easy assembly and long lasting use. Please take the time to read and follow the assembly instructions carefully.

Be sure to check all packing material carefully for small parts which may have come loose inside the carton during shipment. Please separate, identify, and count all parts and metal hardware. Compare with part list to be sure all parts are present. If hardware is missing or you have difficulty assembling this product, please call for us.

DINING CHAIR

IMPORTANT NOTE:

- Place all wooden parts on a clean and smooth surface such as a rug or carpet to avoid the parts from being scratched.
- Remove all wrapping material, including staples & packing straps before you start to assemble.
- DO NOT tighten all screws and bolts until completely assembled.
- Keep all hardware parts out of reach of children.







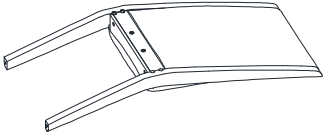
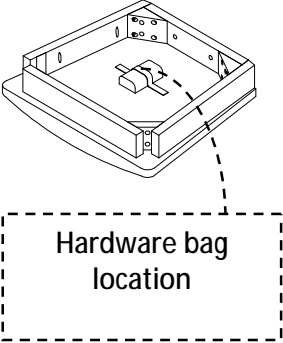
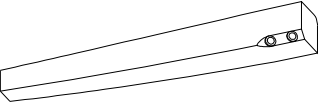

PART LIST

When unpacking, please be careful not to discard any parts with the packaging. Before continuing, please make sure you have the following parts:

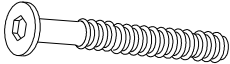
NO	Description	Qty	Sketch	NO	Description	Qty	Sketch
A	Chair back	1		B	Seat Frame	1	 <p style="text-align: center;">Hardware bag location</p>
C	Front Leg	2					

HARDWARE LIST

When unpacking, please be careful not to discard any parts with the packaging. Before continuing, please make sure you have all of the following hardware:

NO	Description	Qty	Sketch	NO	Description	Qty	Sketch
1	Long bolt (M6x80mm)	4		2	Medium bolt (M6x60mm)	4	
3	Short bolt (M6x40mm)	2		4	Lock Washer (Ø6.5X9)	10	
5	Flat Washer (Ø6.5x19)	10		6	Allen Key (4mm)	1	

STEP 1

Attach frame (B) to the back (A) by using bolts (3) and (1) and washers (4) and (5). Tighten **slightly** with Allen Key (6).

Note: **DO NOT fully tighten any bolt until the all chair components are put together.**

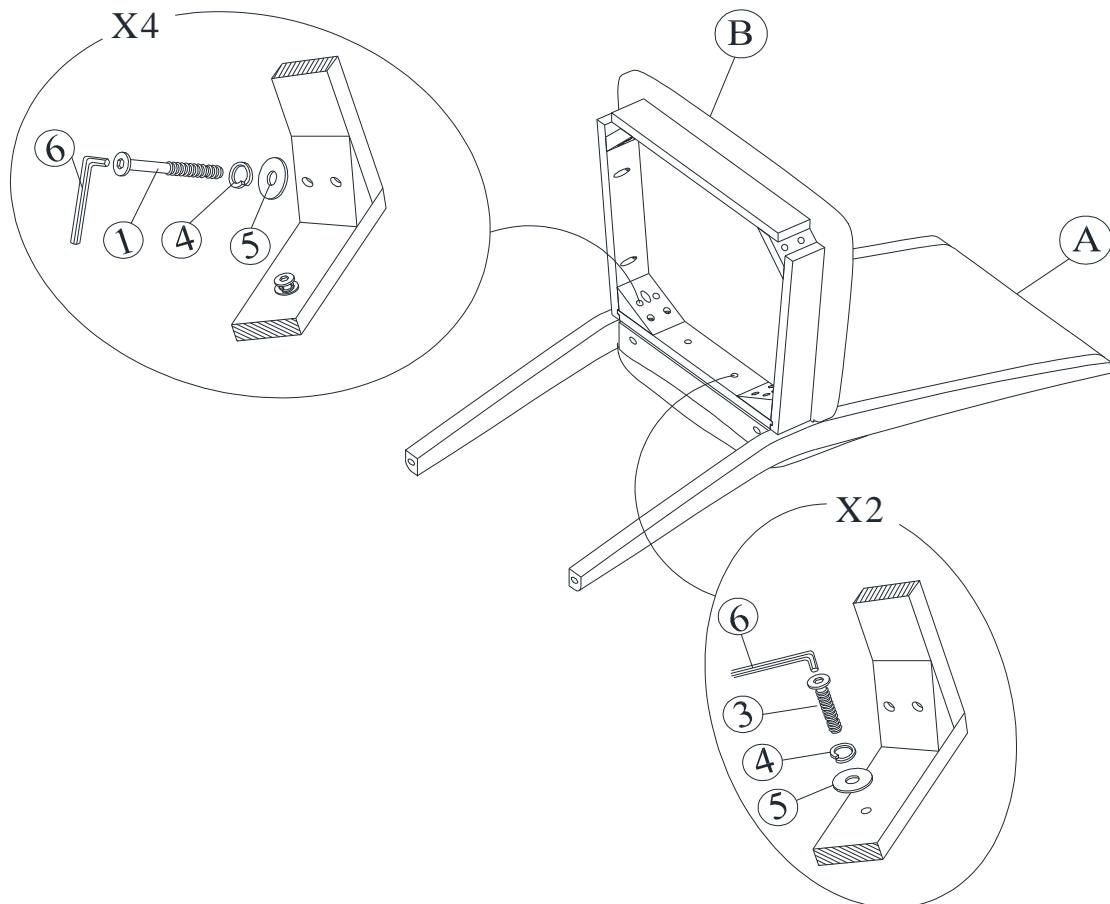

STEP 2

Attach front legs (C) to the seat frame using bolts (2), washers (4) and (5). Tighten slightly with Allen Key (6).

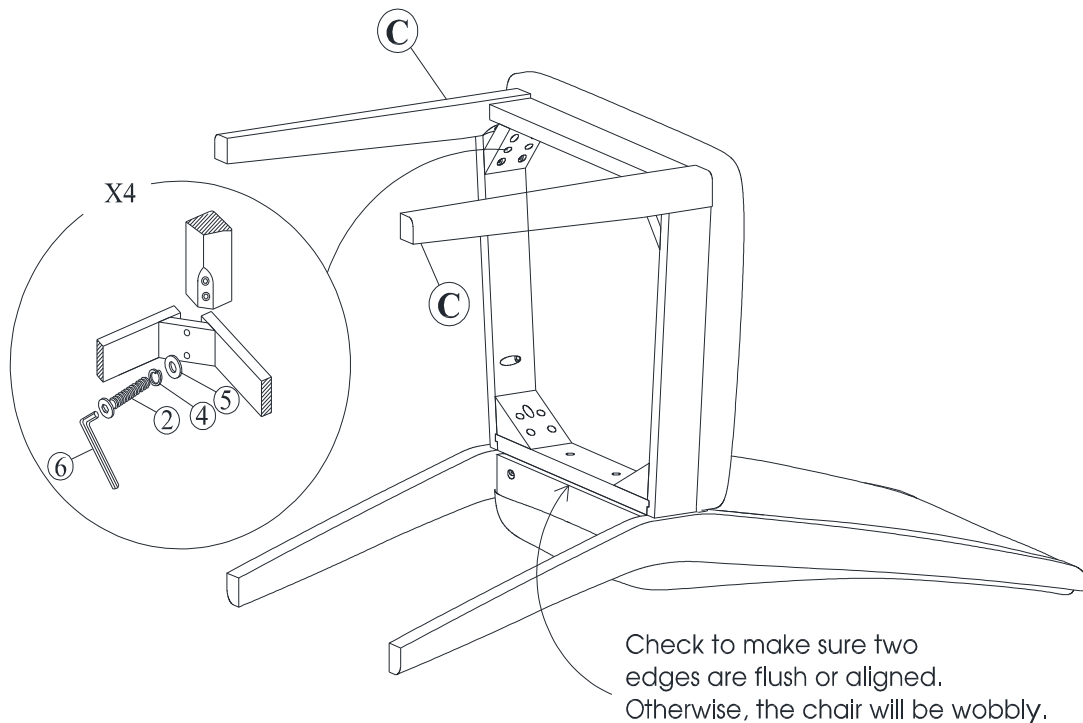

Place the chair on a flat level surface to make sure the chair is levelled and then tighten fully the all bolts.

STEP 3

