

ASSEMBLY INSTRUCTIONS

DINING BENCH

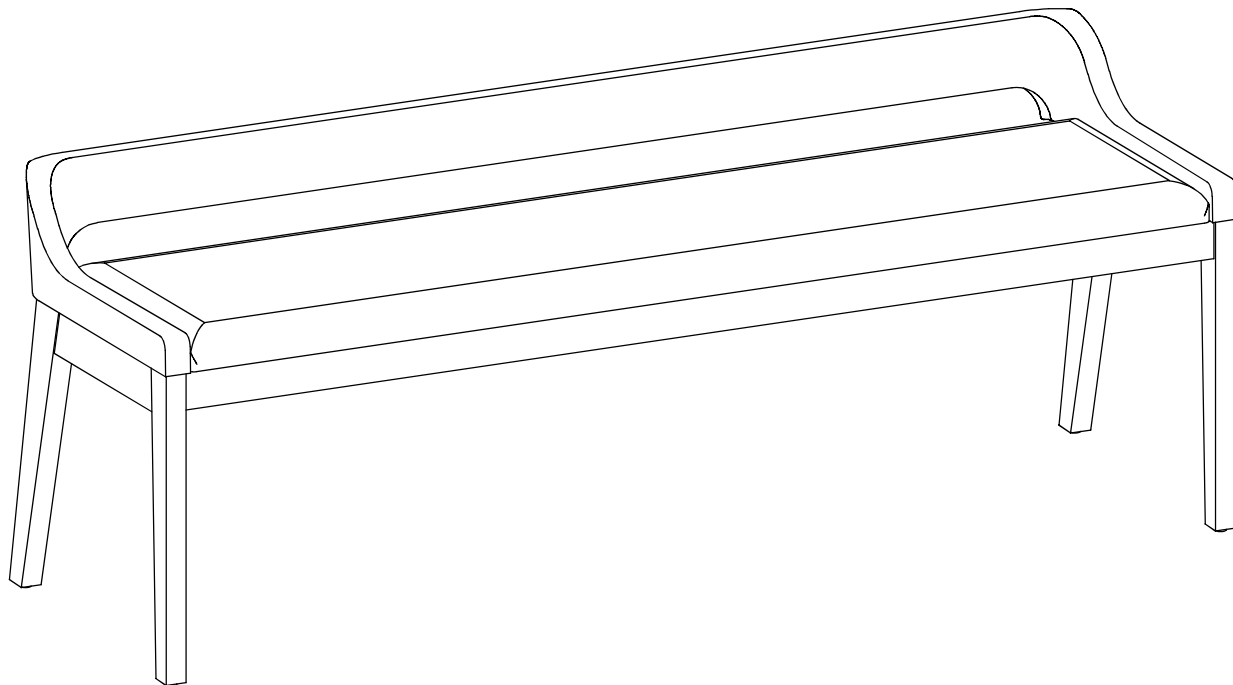



M8*10
8 PCS

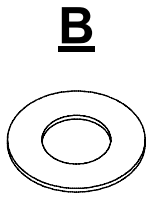

M8*16
8 PCS

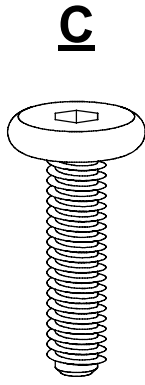

M8*45
8 PCS

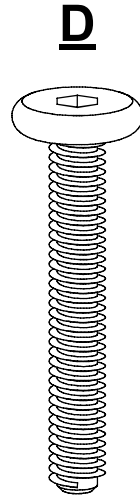

M8*50
2 PCS

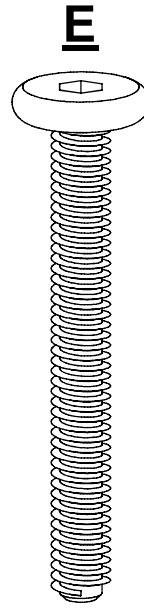

M8*70
4 PCS

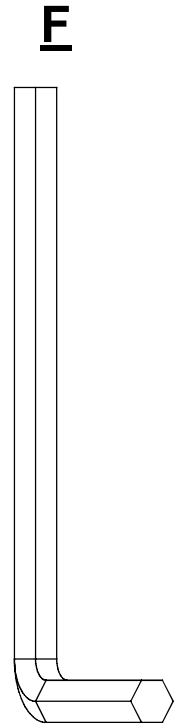

M4*110
1 PC

1

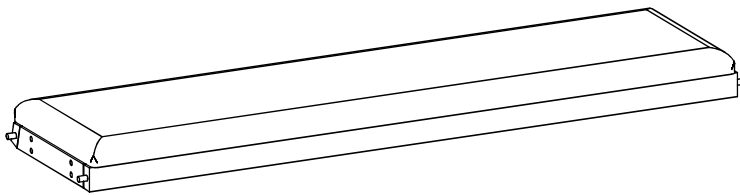

2

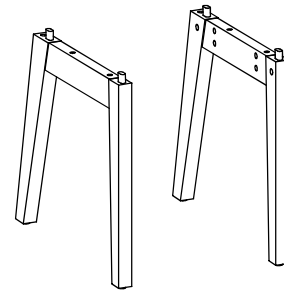

3

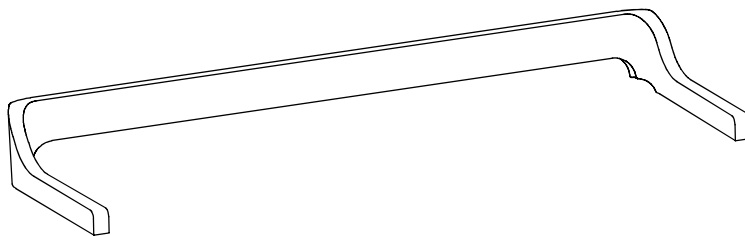

01

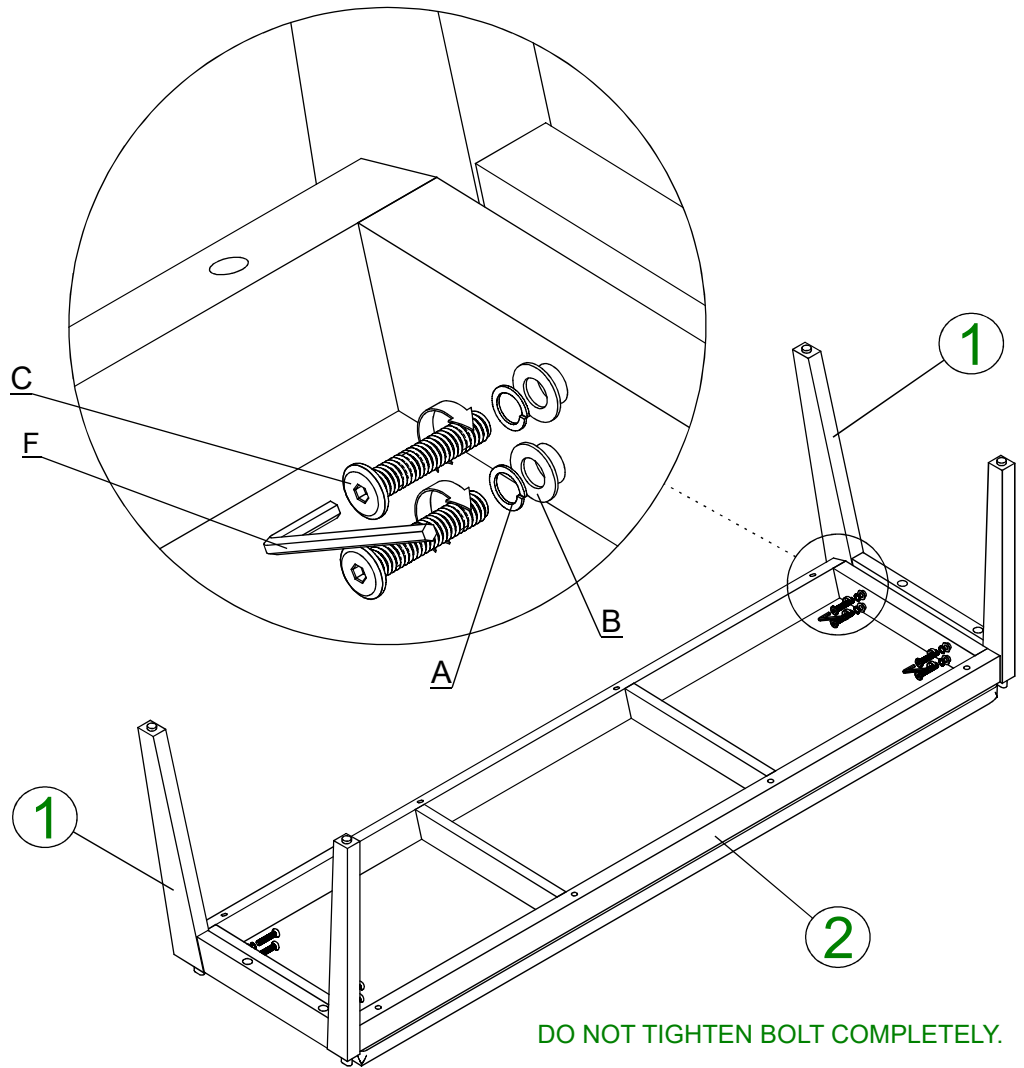
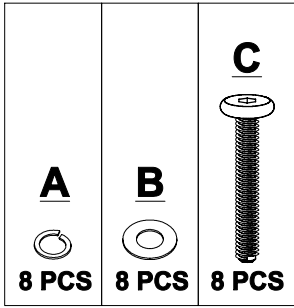

DO NOT TIGHTEN BOLT COMPLETELY.

02

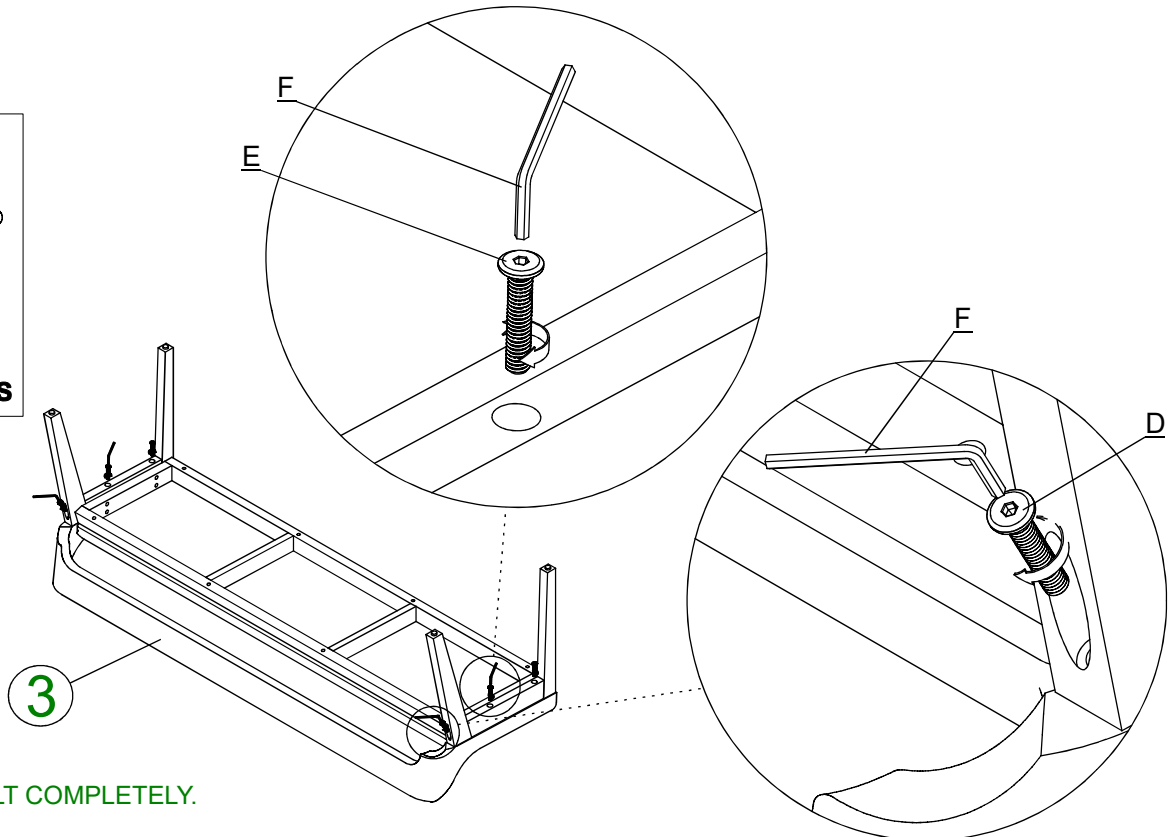
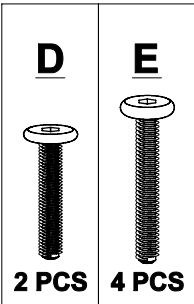

TIGHTEN BOLT COMPLETELY.

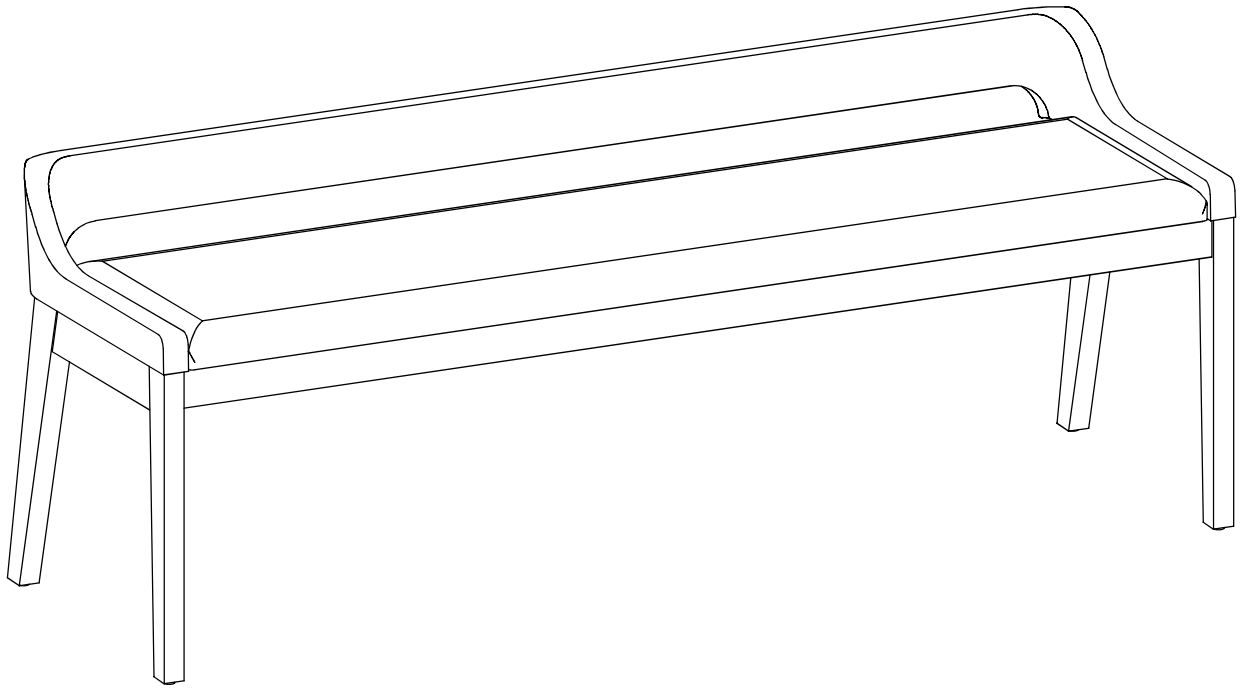

BE SURE TO CHECK ALL BOLTS ARE SECURELY
TIGHTENED PRIOR USING THIS STOOL.