

# PawHut® D32-002 Assembly Instructions

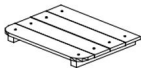

**A** 3.5\*60 18PCS



①X3



②X6



③X2

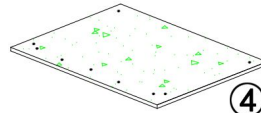

④X2

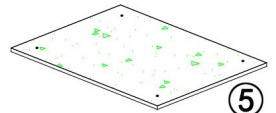

⑤

**B** 3.5\*40 24PCS

**C** 3.5\*35 20PCS

**D** 3.0\*22 12PCS



**M6\*55** 12PCS

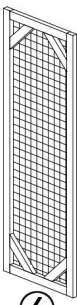

⑥

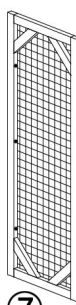

⑦

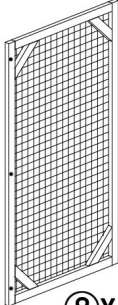

⑧X4

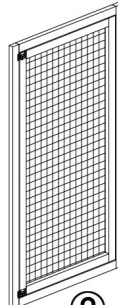

⑨

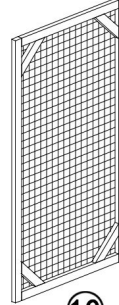

⑩

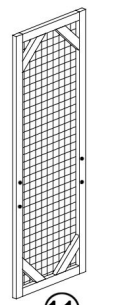

⑪

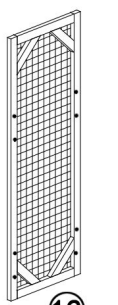

⑫

## Step1

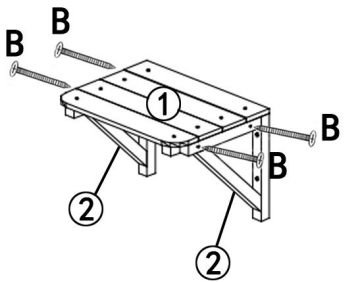

Repeat three times the first step

## Step2

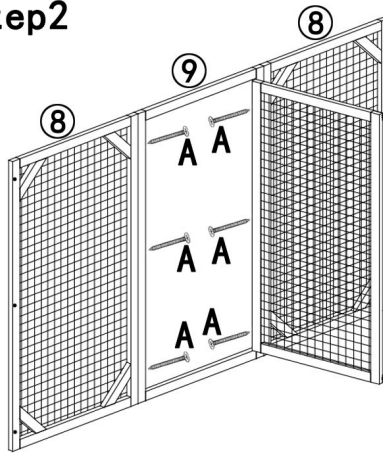

## Step3

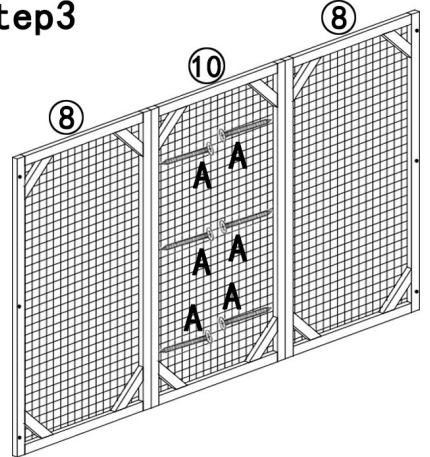

## Step4

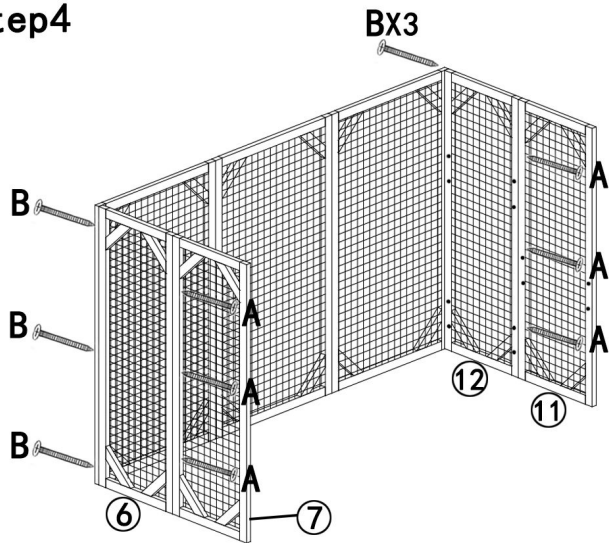

## Step5

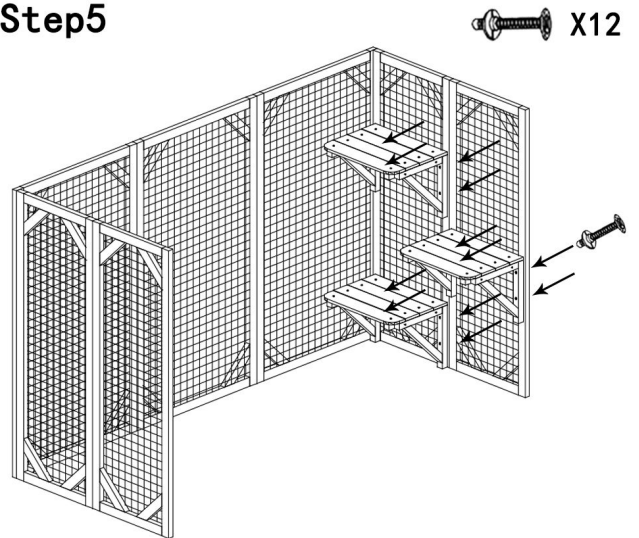

## Step6

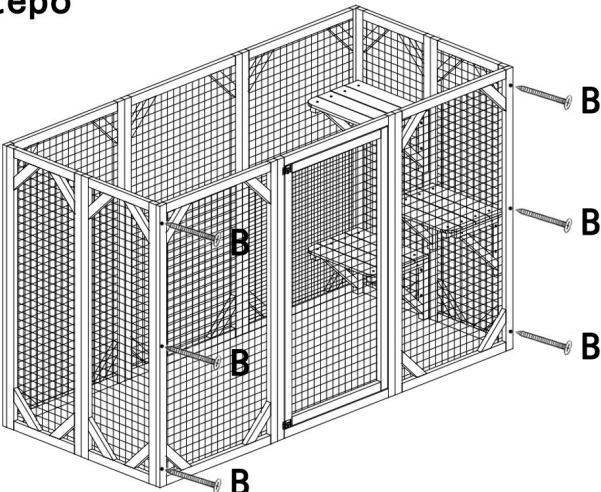

## Step7

