

# Assembly Instructions

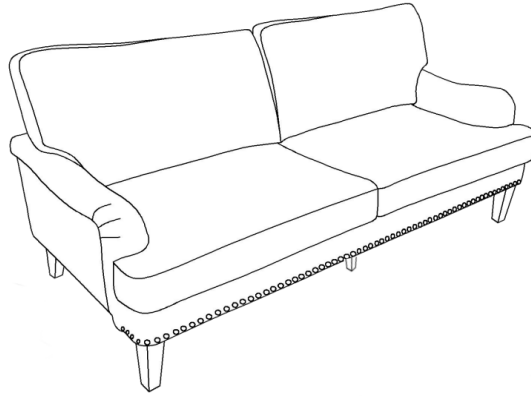

**Caution: You must read this before you proceed**

## Sofa

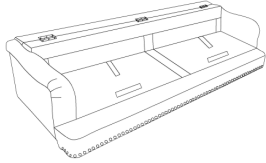
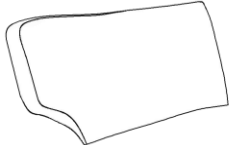
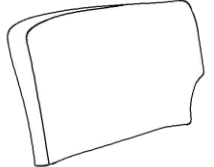
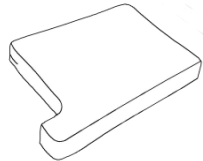
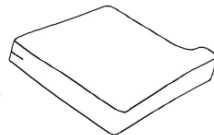

### Parts List

| Label | Picture   | Description        | QTY(pc) |
|-------|---|--------------------|---------|
| A     |  | Seat Base          | 1       |
| B     |  | Left Back Cushion  | 1       |
| C     |  | Right Back Cushion | 1       |
| D     |  | Left Seat Cushion  | 1       |
| E     |  | Right Seat Cushion | 1       |

|   |   |  |   |
|---|---|--|---|
| F |  | Hidden Leg with 1 Silicone Gasket and 1 Plastic Gasket | 2 |
| G |  | Front Leg with 1 Plastic Gasket                        | 2 |
| H |  | Middle Leg with 1 Plastic Gasket                       | 1 |

## Hardware List

| Label | Picture   | Description    | QTY |
|-------|---|----------------|-----|
| ①     |  | Plastic Gasket | 8   |

## Assembly Preparation

Before Beginning Assembly:

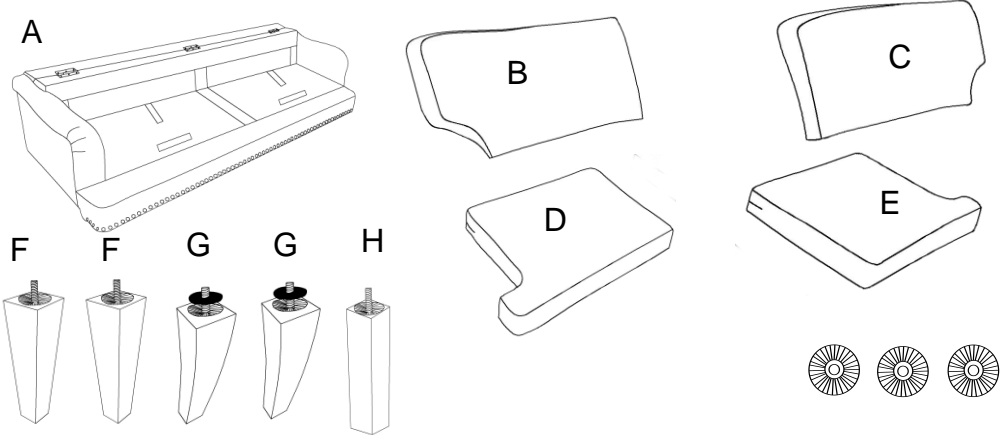

- Read instructions, cover to cover-



- Have 2 adults on hand for assembly-



- Do not assemble on flooring or carpet-



- Assemble on a clean non-marring surface (packing foam)-



- Save all packaging until finished-

# Assembly Steps

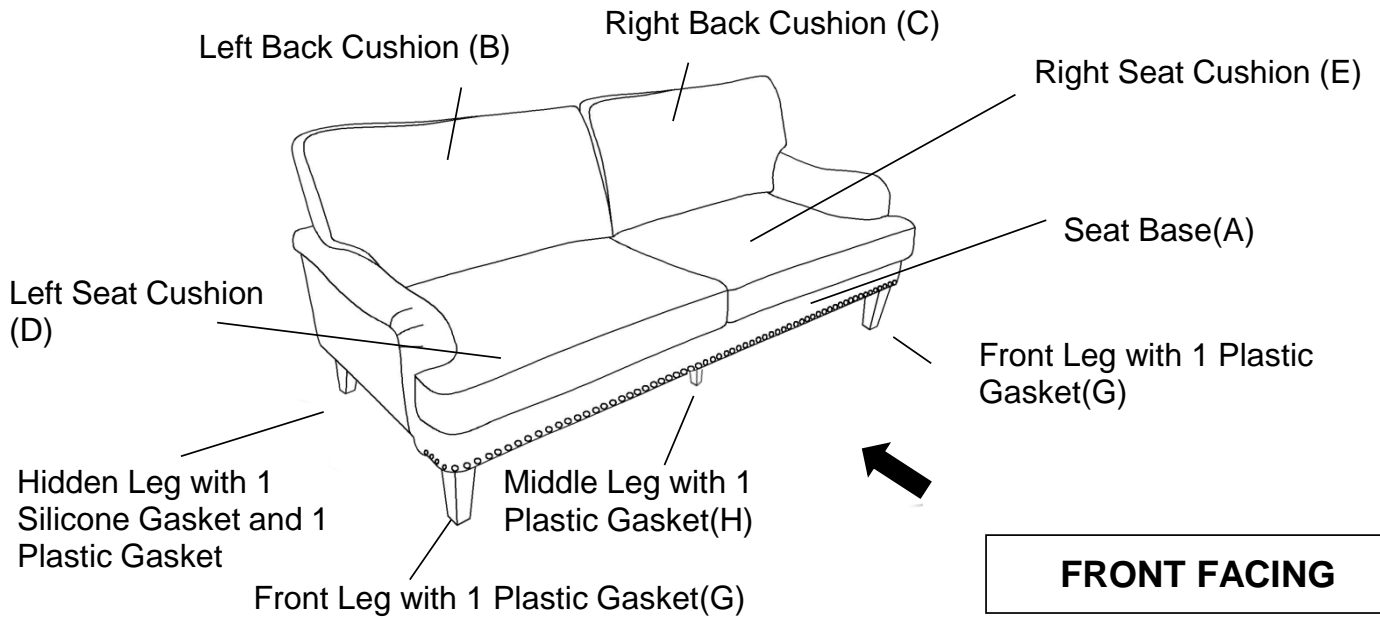

This Sofa has multiple parts and may require about 30 minutes to assemble. To give you an overview of the Sofa parts, the above picture is to help you put the various parts into perspective. Please read through the instructions below to familiarise yourself with the parts and steps before assembly.

## Step 1

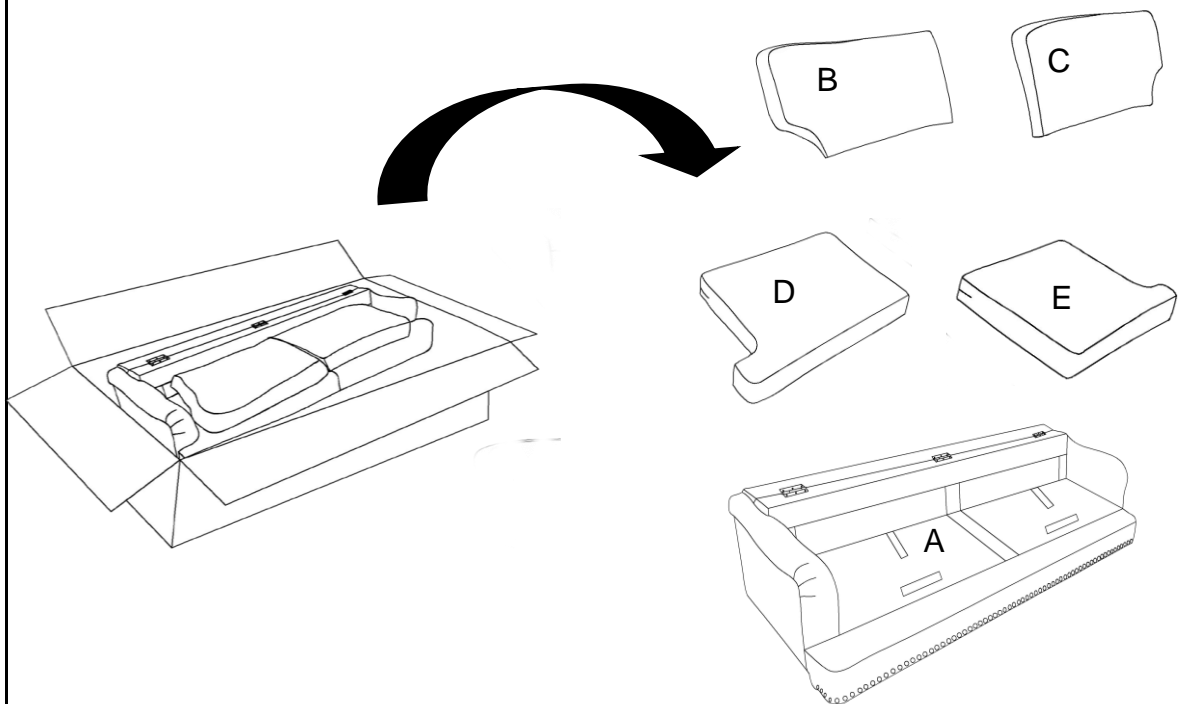

Take out the Seat Base (A), Left Back Cushion (B), Right Back Cushion (C), Left Seat cushion (D) and Right Seat Cushion (E), place them on a clean, non-marring surface.

## Step 2

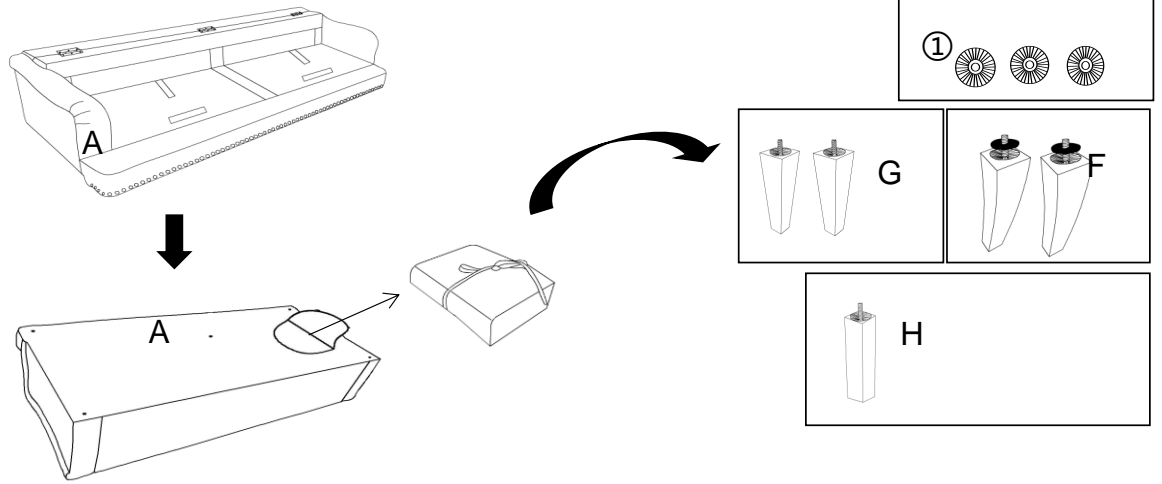

Unzip the non-woven pocket under the Seat Base(A) and take the small Carton Box out to Open it to take out the Plastic Gasket(①),Front Legs with 1 Plastic Gasket(G),Hidden Legs with 1 Silicone Gasket and 1 Plastic Gasket(F) and Middle Leg with 1 Plastic Gasket.

## Step 3

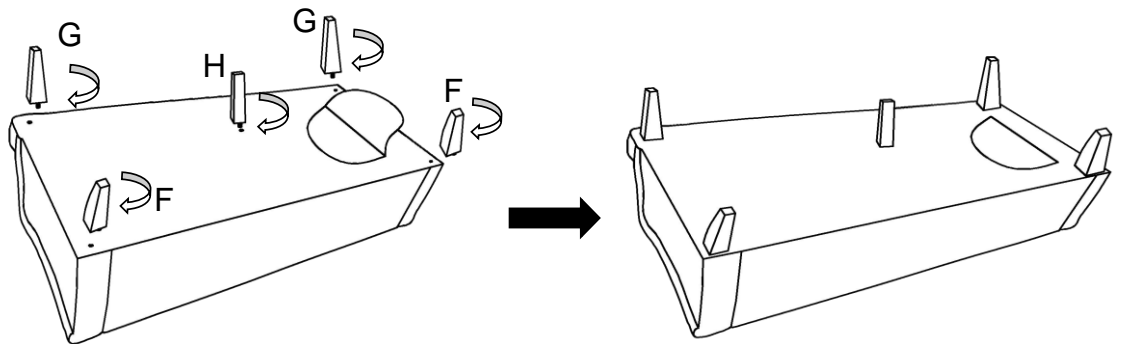

Carefully install the Front Legs with 1 Plastic Gasket(G), Hidden Legs with 1 Silicone Gasket and 1 Plastic Gasket(F) and Middle Leg with 1 Plastic Gasket at the bottom of Left Arm(C) and Right Arm(D) at the bottom of Seat Base(A).

Insert threaded stem into the mounting position at the corner and middle of the Seat Base(A). Tighten by turning the Legs clockwise.

Take care of the shape of the Legs and ensure they in the correct postions.

**Note:**The use of Gaskets are **OPTIONAL** and are especially useful to help alleviate slight wobbleness. Some Legs may need more than one gasket while some legs may not need anyny.

## Step 4

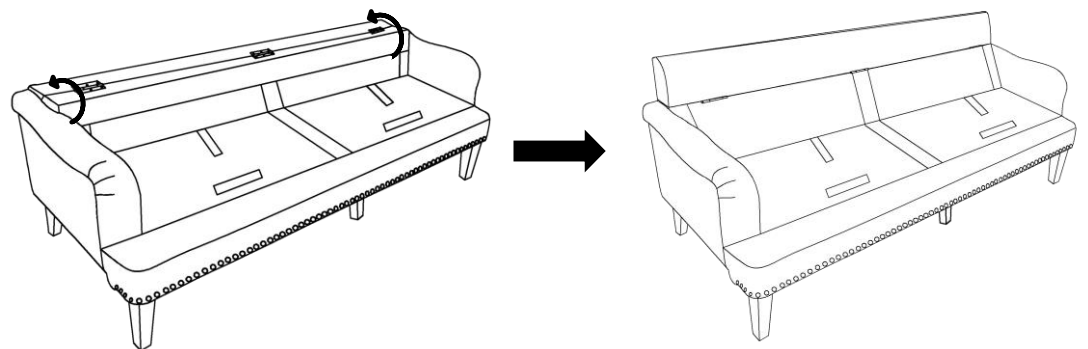

Turn the folding back up as pictured.

**Step 5**

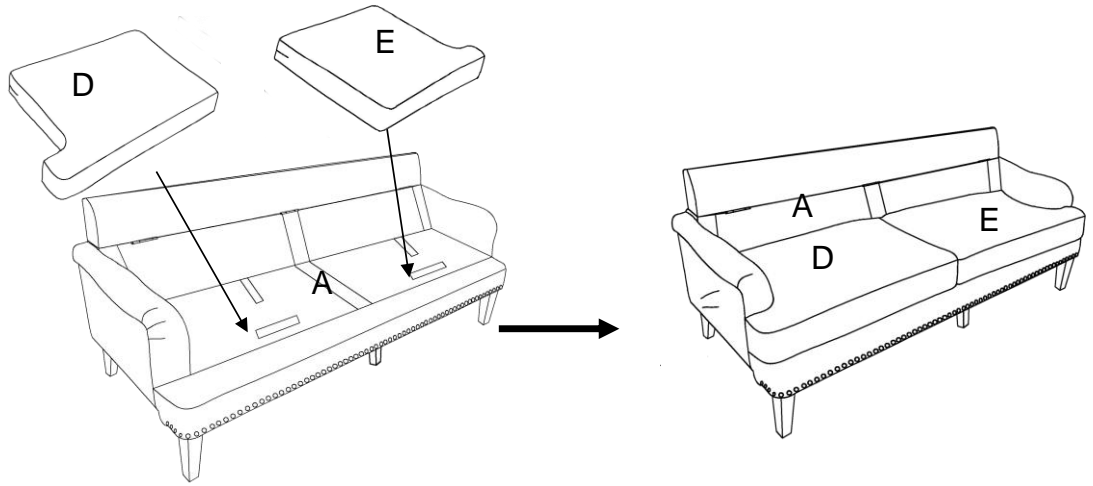

Put the Left Seat Cushion(D) and Right Seat Cushion(E) on the Seat Base (A).

**Step 6**

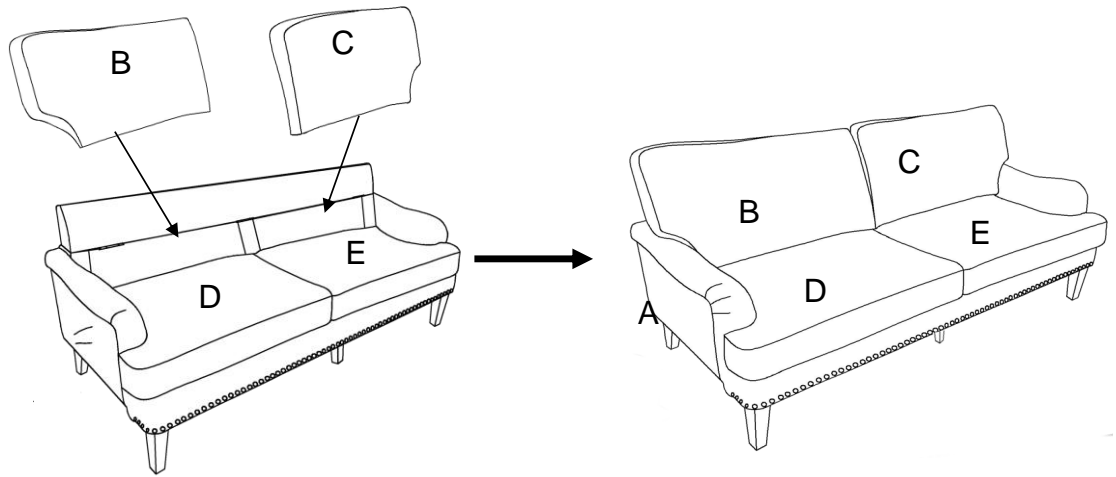





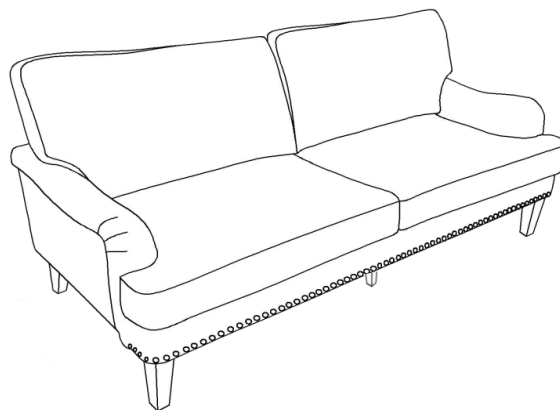





Put the Left Back Cushion(B) and Right Back Cushion(C) on the Seat Cushions against the back as pictured.

**Step 7**



Your Sofa is ready for use.  
This Sofa can only be used on a flat, level surface.

## Care & Maintenance

-  Do not put hot items directly on furniture surface
  -  Do not clean furniture with harsh cleansers or polish.
  -  Do not place furniture under direct sunlight.
  -  Do not place furniture near heating or cooling vents.
  -  Do not write on furniture without a padded barrier to protect the surface.
  -  Do not place furniture outside . For indoor use only .
  -  Not for commercial use. For residential use only .
  -  Stains may be removed with mild soap solution and damp cloth.
  -  Children should not climb or jump on the furniture.
- 
-  Dust and pick-up spills using a clean, non-colored, lint-free cloth .

### Questions & Answers about Proposition 65

#### • What is Proposition 65?

Proposition 65 requires businesses to provide warnings to Californians about significant exposures to chemicals that cause cancer, birth defects or other reproductive harm. These chemicals can be in the products that Californians purchase, in their homes or workplaces, or that are released into the environment. By requiring that this information be provided, Proposition 65 enables Californians to make informed decisions about their exposures to these chemicals.

Proposition 65 also prohibits California businesses from knowingly discharging significant amounts of listed chemicals into sources of drinking water.

Proposition 65 requires California to publish a list of chemicals known to cause cancer, birth defects or other reproductive harm. This list, which must be updated at least once a year, has grown to include approximately 900 chemicals since it was first published in 1987.

#### • What types of chemicals are on the Proposition 65 list?

The list contains a wide range of naturally occurring and synthetic chemicals that include additives or ingredients in pesticides, common household products, food, drugs, dyes, or solvents. Listed chemicals may also be used in manufacturing and construction, or they may be byproducts of chemical processes, such as motor vehicle exhaust.

#### • What does a warning mean?

If a warning is placed on a product label or posted or distributed at a workplace, a business, or in rental housing, the business issuing the warning is aware or believes that it is exposing individuals to one or more listed chemicals.

By law, a warning must be given for listed chemicals unless the exposure is low enough to pose no significant risk of cancer or is significantly below levels observed to cause birth defects or other reproductive harm.