

STEP 5

Attach Panel (B) to Panel (D) with Screw (1).

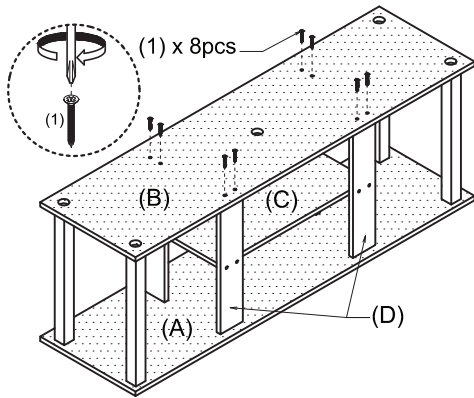

STEP 6

- 6.1 Tighten Pole (3) with Square Leg (5), as shown.
- 6.2 Fix Square Leg (5) at center of Panel (B) with Top Cap (6), as shown.

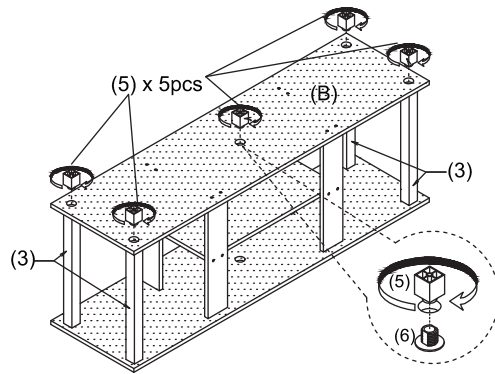

STEP 7

Upright the unit.
Unfold the Bins (7) and slide into the storage.
Cover the screw position with Screw Cap (9).

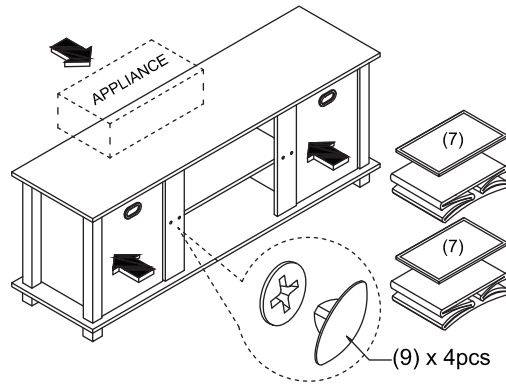

RECOMMENDED MAXIMUM WEIGHT

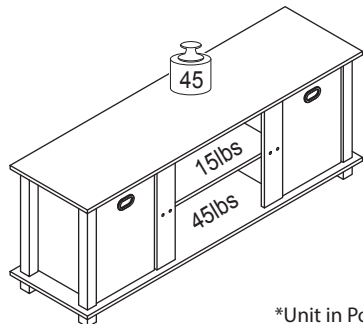

*Unit in Pound(lbs)

NOTE:

>This unit has been designed to support the maximum loads shown. Exceeding these load limits could cause sagging, instability, product collapse, and/or serious injury.

>DO NOT allow children to climb on unit.

>Put heavier items on lower shelves.

>Recommended to install the appliances from the back of unit.



Assembly Instruction

Furinno Econ Entertainment Center
w/Storage Bins

MODEL : 13054

DIMENSION : 41.7"(W) x 15.8"(H) x 11.7"(D)

00:20

Approx. 20 minutes



Recomm. 1 Person

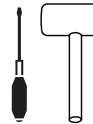

Tool Required

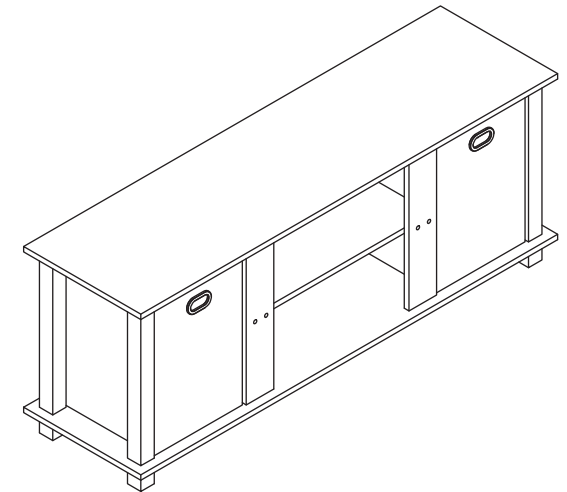

Customer Service

Tel/Fax: 281.500.9372











Toll Free: 773.299.8111 (Mon - Fri 9am - 5pm)



Email: support@furinno.com

www.furinno.com

Find us on
Facebook

Pinterest

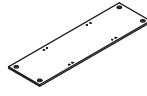
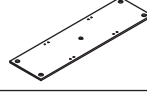
No	Hardware List	Qty
1	Screw M4x32mm 	16pcs
2	Dowel 	8pcs
3	Square Long Pole 	4pcs
4	Insert Cap 	4pcs
5	Square Leg 	5pcs
6	Top Cap 	1pc
7	Non-Wooven Bin 	2pcs
8	White Glue 	1pc
9	Screw Cap Cover 	4pcs
10	L-Bracket 	4pcs
11	Screw M3.5x10mm 	8pcs

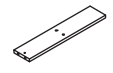
No	Parts List	Qty
A	Top Panel 	1pc
B	Bottom Panel 	1pc
C	Shelf Panel 	1pc
D	Leg Panel 	4pcs

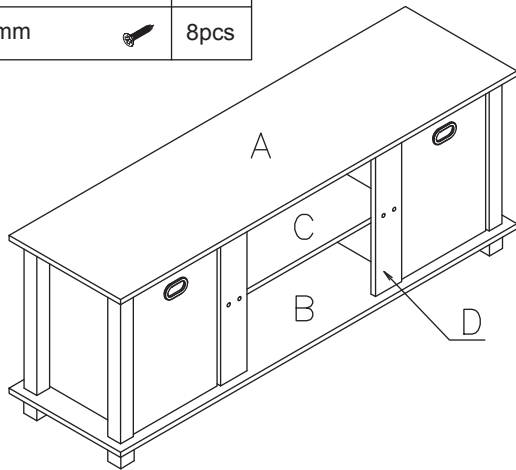

USEFUL HINTS BEFORE YOU START:

1. Read each step carefully before starting.
2. It is important that each step is performed in correct order to avoid difficulties.
3. Identify, sort and count the parts before assembly.
4. Assemble your furniture on packaging cardboard to prevent scratch or damage.
5. Clean the product with mild cleanser using soft damped cloth. Do not use harsh or abrasive cleanser.
6. Using incompatible hardware might cause damage to product.

STEP 1

Insert Dowel (2) to Panel (D) with Glue (8).
Tighten Bracket (10) to Panel (D) with Screw (11).

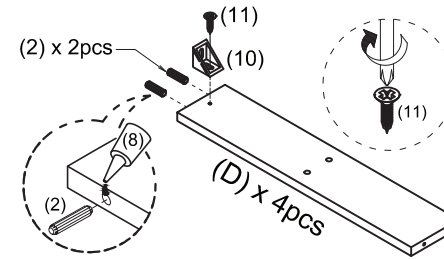

STEP 2

Install Insert Cap (4) to Panel (A) with hammer.

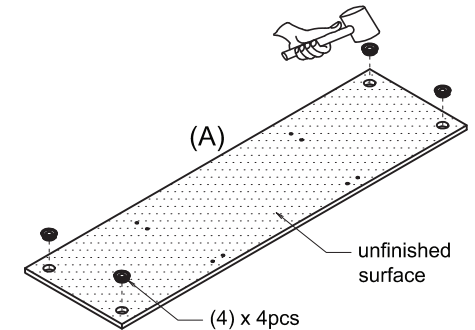

STEP 3

Attach Panel (D) to Panel (A) with Screw (11) & Glue (8), as shown.

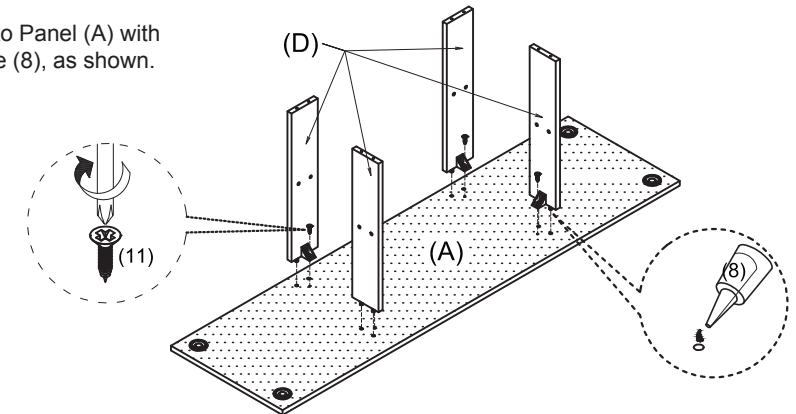

STEP 4

- 4.1 Attach Panel (C) to Panel (D) with Screw (1).
- 4.2 Tighten Poles (3) to Insert Cap (4).

