

WARNING

- * Switch off the main electrical supply from the main fuse box / circuit breaker before installation.
- * Inspect item carefully before attempting to install.
- * If there is any damages or obvious defects, do not install.
- * Item may not be returned once it has been installed.















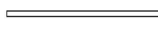

CARE AND MAINTENANCE

- * To clean the outside of the fixture, use a dry or slightly dampened clean cloth (use clean water, never a solvent) to wipe the surface of the fixture.
- * To clean the inside of the fixture, first disconnect power to the fixture by turning off the circuit breaker or by removing the fuse at the fuse box. Next, use a dry or slightly dampened clean cloth (use clean water, never a solvent) to wipe the interior surface of the fixture.
- * Do not use any cleaners with chemical, solvents or harsh abrasives. Use only a dry soft cloth to dust or wipe carefully.

NOTICE& IMPORTANT SAFETY INSTRUCTIONS

- ** WE RECOMMEND INSTALLATION OF THIS LIGHTING FIXTURE BE DONE BY A LICENSED ELECTRICIAN **
- * Please make sure that you have all parts indicated before you begin assembly of this item
- * This item should be assembled on a soft surface to prevent scratching the finish during assembly
- * To reduce the risk of fire, electrical shock or injury to persons or property, please follow the guideline below for safe use and installation
- *The external flexible cable or cord of this lamp cannot be replaced
If the cord is damaged, the lamp shall be destroyed

Part List and Hardware List

PIECE	DESCRIPTION	PICTURE	QUANTITY	PIECE	DESCRIPTION	PICTURE	QUANTITY
A	Wire Connector		3X	J	Fixture Loop		1X
B	Mounting Plate		1X	K	Cap		1X
C	Ground Screw		1X	L	Middle Box		1X
D	Mounting Screw		2X	M	Rod		3X
E	Hang Loop		1X	N	Steel Wire Frame		1X
F	Closable Link		7X	O	Connecting Rod		1X
G	Canopy		1X	P	Lamp Body		1X
H	Chain		1X	Q	Ball Screw		3X
I	Canopy Nut		1X	R	Bulb		6X

Product Dimensions: 26"L X 26"W X 33-92"H

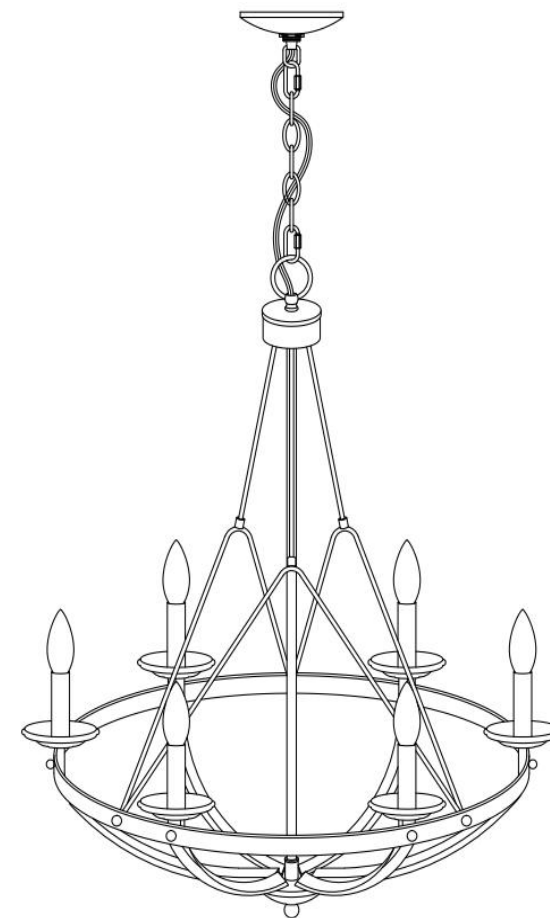

PREPARATION

- * Before beginning assembly of product, make sure all parts are present. Compare parts with package contents list and hardware contents list.
- * If any part is missing or damaged, do not attempt to assemble the product.
- * Estimated Assembly Time: 20 minutes.
- * Tools Required for Assembly (not included): Screwdriver, Junction box
- * If you are having difficulty, our friendly Customer Care team is always here to help.

NOTE: PLEASE USE TYPE"B" BULB MAX 40-WATT OR LED BULB MAX 4-WATT, THERE ARE 6PCS LED 4-WATT BULB IN THE BOX

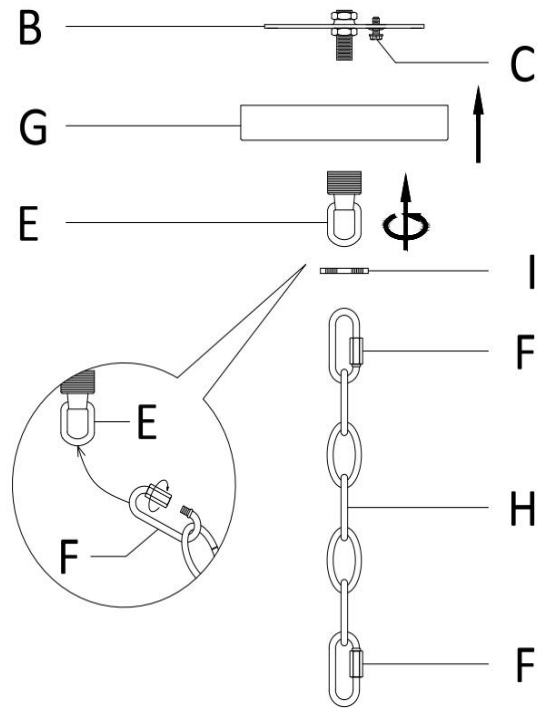

Step 1: Unpack all parts from cartons carefully. Place the Canopy (G) onto the Hanging Loop(E). Place the nipple of Mounting Plate (B) into the threaded portion of the Hanging Loop(D) and fix it by turing the Canopy Nut (I) clockwise till tight. Use Closable Link (F) attach the Chain (H) end onto the Hanging Loop (E).

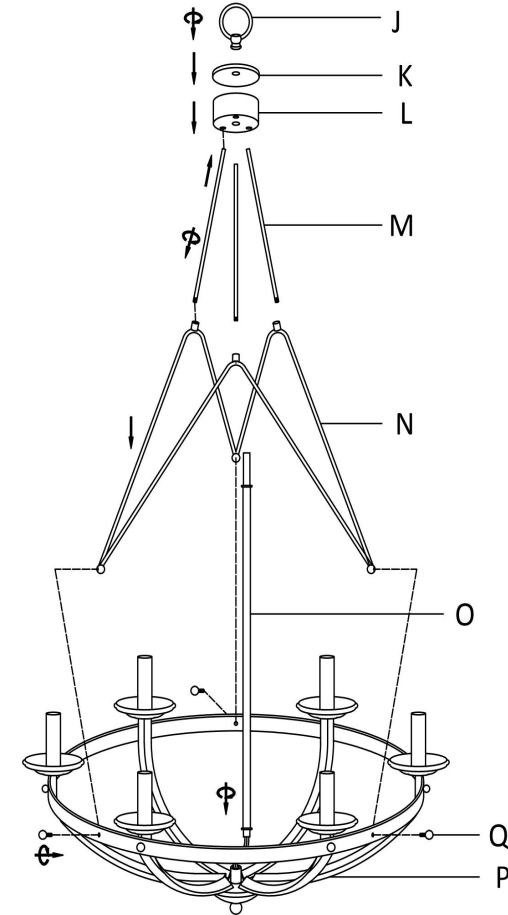

Step 2: Thread the Center Rod (O) to coupling of the Lamp Body (P). Place the Steel Wire Frame (N) to the steel ring of the Lamp Body (P), then secure with the Ball Screws (Q). Place the Middle Box (L) to the Center Rod (O), Insert Steel Rod (M) smooth end into Middle Box (I) and thread other end to the Steel Wire Frame. Insert Cap (K) over Middle Box (L), Then secure with the Fixture Loop (J).

PREPARATION

- * Before beginning assembly of product, make sure all parts are present. Compare parts with package contents list and hardware contents list.
- * If any part is missing or damaged, do not attempt to assemble the product.
- * Estimated Assembly Time: 20 minutes.
- * Tools Required for Assembly (not included): Screwdriver, Junction box
- * If you are having difficulty, our friendly Customer Care team is always here to help.

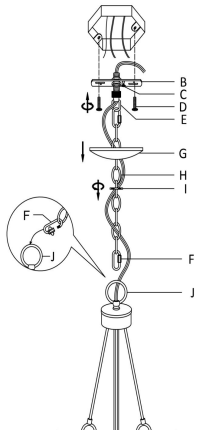

Step 3: Use Closable Link (F) attach the Chain (H) end onto the Fixture Loop (J). Separate the Mounting Plate (B) from the Canopy (G) by turning the Canopy Nut (I) anti-clockwise. Install the Mounting Plate (B) to the junction box with Mounting Screw (D). Gently cord and ground wire through Canopy Nut (I) and Canopy (G), then through Chain (H) about every third link. Next, carefully thread cord and ground wire through hole in Canopy Loop (E) and pull into Junction Box in preparation for electrical connection in next step. Permit cord and wire to hang freely next to Chain.

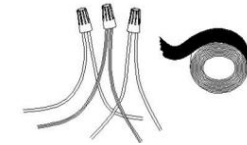
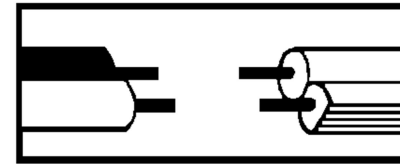

Step 4: Wire connection

Connect fixture neutral wire (ribbed) to the outlet box neutral wire (usually white) using a wire connector (A).

Connect fixture hot wire (smooth with markings) to the outlet box hot wire (usually black) using a wire connector (A).

CAUTION: Do not reverse the hot and neutral connections

Grounding Instructions:

Wrap ground wire from outlet box around green ground screw (C) on mounting bracket, no less than 2" from wire end. Tighten ground screw. If fixture is supplied with a ground wire, connect to outlet ground wire with a wire connector (A).

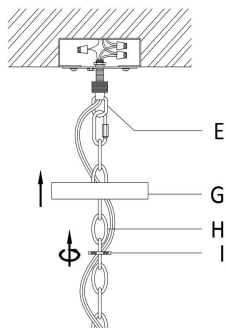

Step 5: Tuck wires inside junction box. Attach the Canopy (G) to the junction box and fix it by turning the Canopy Nut (I) clockwise.

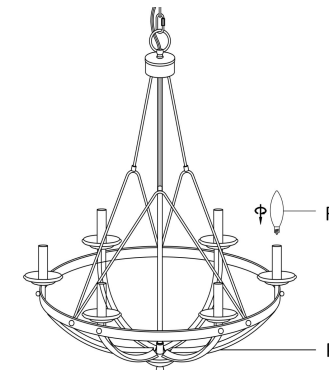

Step 6: Insert the Bulbs (R) into the socket.