

## CARE AND MAINTENANCE

Spot clean using a mild water-free solvent. Only a professional cleaner should undertake a complete overall cleaning.

The use of steam or water-based cleaners may cause excessive shrinking or staining.







## NOTICE

\* Please make sure that you have all parts indicated before you begin assembly of this item

\* This item should be assembled on a soft surface to prevent scratching the finish during assembly

\* This item may require periodic tightening

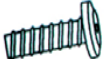
## Part List and Hardware List

PIECE	DESCRIPTION	PICTURE	QUANTITY
A	Seat ( Cushion)		1X
B	Legs		4X
C	Metal shelf		1X
D	Feet		4X
H1	Allen bolt		8X
H2	Allen key		1X

Product Dimensions: DIA 15.13" X 18.25"H

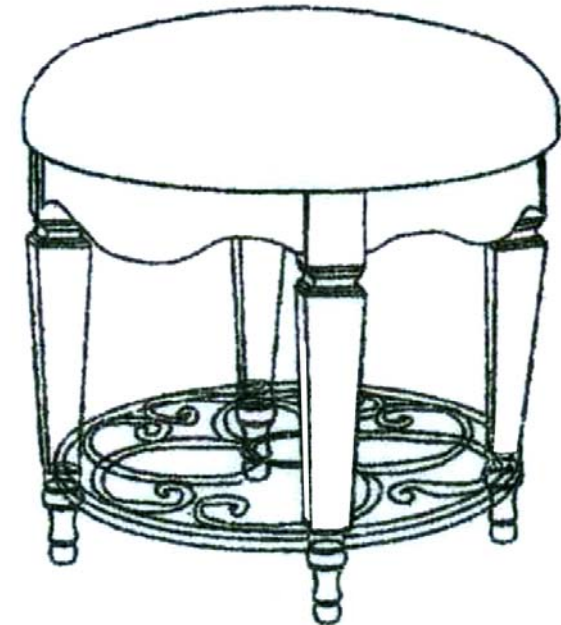

## PREPARATION

Before beginning assembly of product, make sure all parts are present. Compare parts with package contents list and hardware contents list.

If any part is missing or damaged, do not attempt to assemble the product.

Estimated Assembly Time: 10 minutes.

Tools Required for Assembly (included): Allen Key

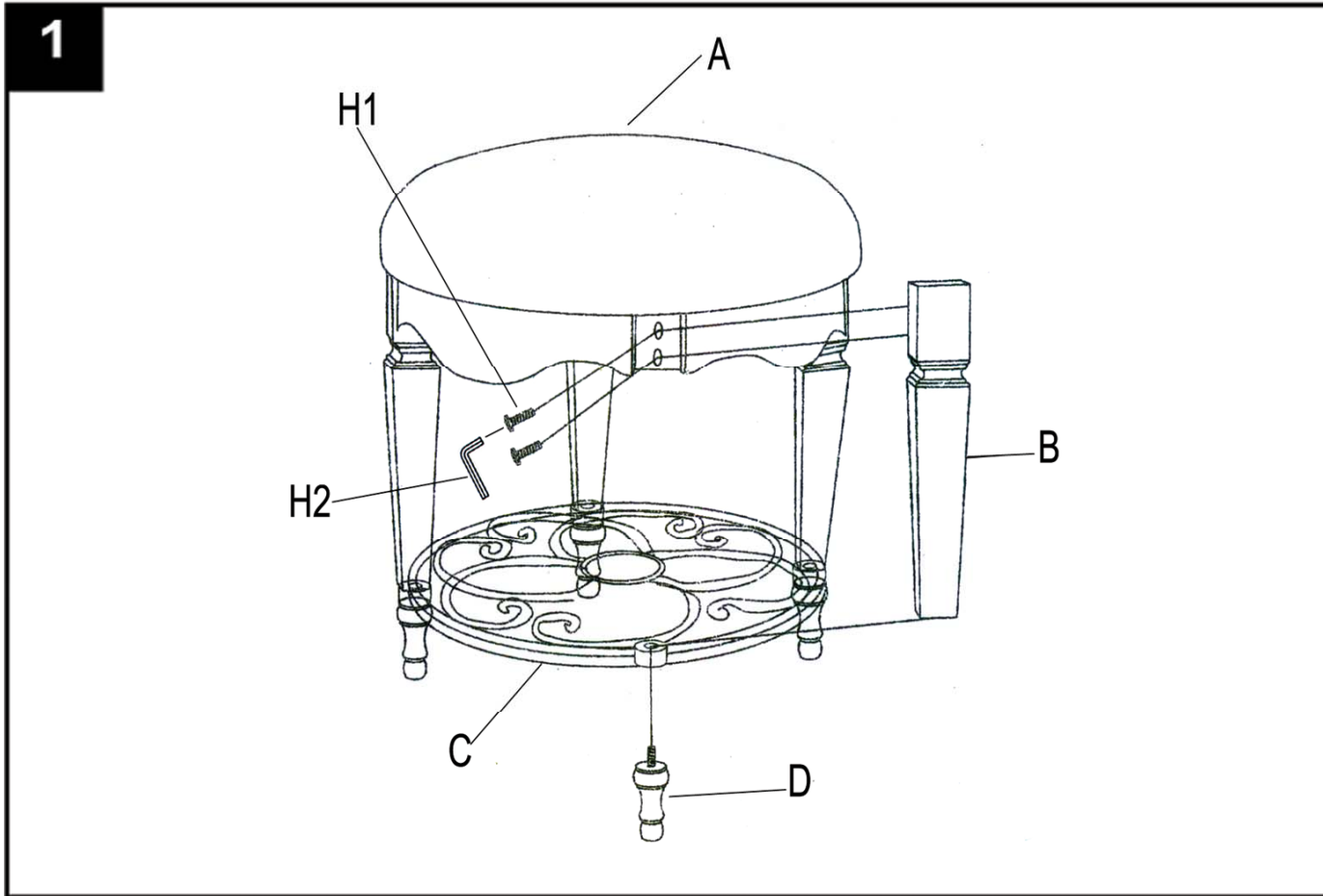

### Step 1

Put the legs (B) into the seat and put on the metal shelf©, use Allen key (H2) to tighten the bolts on the legs