

# USER'S MANUAL

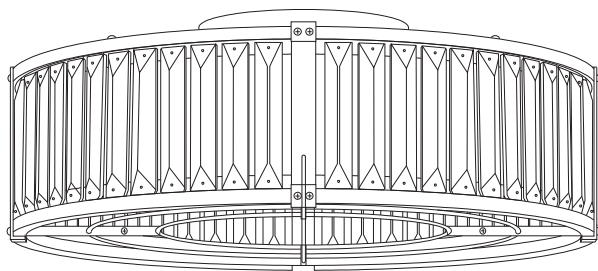

# WARNING!!!

**To avoid fire, shock and serious personal injury, follow these instructions.**

1. Read your user manual and safety information before installing your new fan. Review the accompanying assembly diagrams.
2. Before servicing or cleaning the unit, switch off the power at the service panel and lock it to prevent accidental power restoration. If the service disconnecting means cannot be locked, securely fasten a warning device, such as a tag, to the service panel.
3. Exercise caution around the fan and its blades when clearing, repairing, or working near it. Always turn off the power to the ceiling fan before performing any maintenance
4. Do not insert anything into the fan blades while the fan is in operation.
5. This appliance is not intended for use by young children or individuals with disabilities without supervision. Young children should be supervised to ensure they do not play with the appliance.
6. Before installing your ceiling fan, refer to the section on the proper method of wiring your fan. If you feel you lack sufficient wiring knowledge or experience, it is recommended to have your fan installed by a licensed electrician.

## Before Installation

- This manual is designed to make it as easy as possible for you to assemble, install operate and maintain your ceiling fan.

NOTE: Place the parts from the loose parts bags in a small container to keep them from being lost. If any parts are missing contact us.

### TOOLS REQUIRED



Step ladder

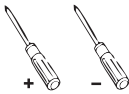

Phillips head screw drivers

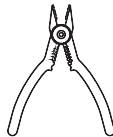

Wire strippers







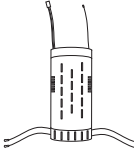
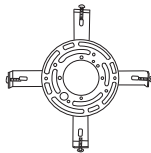

### MATERIALS

Wiring outlet box and box connectors must be of type required by the local code. The minimum wire would be a 3-conductor (2wire with ground) of the following size:

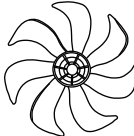
Installed wire length	Wire AWG
Up to 50 ft	14
50-100 ft	12

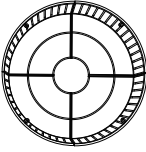

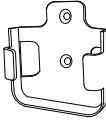





# Package Contents

● Check to see that you have received the following parts

<p>1 (aa)</p>  <p>Receiver (pre-installed)</p>	<p>1 (bb)</p>  <p>Ceiling plate (pre-installed)</p>	<p>1 (cc)</p>  <p>Fan motor host</p>
<p>1 (dd)</p>  <p>Fan blade</p>	<p>1 (ee)</p>  <p>Blade cap</p>	<p>4 (ff)</p>  <p>Connecting component</p>
<p>4 (gg)</p>  <p>Frame knockdown</p>	<p>1 (hh)</p>  <p>Remote controller</p>	<p>1 (ii)</p>  <p>Remote controller wall plate</p>
<p>3 spare (jj)</p>  <p>Crystal triangular strip</p>	<p>8 spare (kk)</p>  <p>Crystal retaining pin</p>	

# Accessories

● Check to see that you have received the following parts:

<p>3 (A)</p>  <p>Wire Nut</p>	<p>4 (B)</p>  <p>J-box Screw</p>	<p>4 (C)</p>  <p>Self-tapping Screw</p>	<p>4 (D)</p>  <p>Plasticex Pansion Tube</p>
<p>10 (E)</p>  <p>Nuts</p>	<p>(F) 30</p>  <p>Side and Bottom Screws</p>	<p>5 (G)</p>  <p>Frame Screw</p>	<p>4 (H)</p>  <p>Washer</p>

## Energy-Saving Usage

**Ceiling fan performance and energy savings rely heavily on the proper installation and use of the ceiling fan. Here are a few tips to ensure efficient product performance.**

### Choosing the Appropriate Mounting Location

Ceiling fans should be installed or mounted in the middle of the room and positioned at least 7 feet above the floor and 18 inches away from the walls.

If the ceiling height allows, it is recommended to install the fan 7~9 feet above the floor to achieve optimal airflow.

### Turn Off When Not in the Room

If the room is unoccupied, turn off the ceiling fan to conserve energy.

### Using the Ceiling Fan Year Round

**Summer Season:** Use the ceiling fan in the counterclockwise direction. The airflow created by the ceiling fan produces a wind-chill effect, making you feel cooler. Select a fan speed that provides a comfortable breeze; lower speeds consume less energy.

**Winter Season:** Reverse the motor and operate the ceiling fan at a low speed in the clockwise direction. This produces a gentle updraft, which pushes the warm air near the ceiling down into the occupied space. Remember to adjust your thermostat when using your ceiling fan. This simple step can lead to additional energy and cost savings.

# Electrical and Structural Requirements

Your new ceiling fan will require a grounded electrical supply line of AC 110-130V/60Hz and a 15 Amp circuit. According to electrical codes, it is necessary to use a fan-rated outlet box to support the additional weight and motion associated with a ceiling fan. A fan-rated box will be clearly labeled as such and is typically designed to support ceiling fans weighing up to 70 pounds. Fan-rated outlet boxes are available in various ratings and designs. It is essential to ensure that the rating of your ceiling fan outlet box meets the requirements for the specific ceiling fan you are installing. Please refer to the figures below for different structural configurations that can be used for mounting the outlet box.

## Low-profile use (Figure 1)

A 1/2-inch deep pancake box is meant to be screwed to a joist or block. It is used if only one cable is coming into the box. It is also available in a saddle-mount configuration.

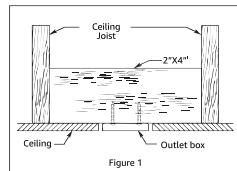

## Deep-profile use (Figure 2)

A 2-1/4" deep box can be attached to blocking between joists and is roomy enough to handle more than one cable.

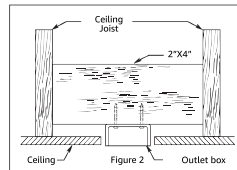

## Brace Use (Figure 3)

Paired with a deep box, this hanger is meant to span between two joists and takes the place of wooden blocking.

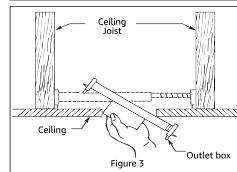

If your fan is to replace an existing light fixture, turn power off at the main fuse box and remove the existing light fixture.

## WARNING

To ensure safety and prevent potential electrical shock, it is not sufficient to simply turn off the wall switch. Prior to wiring, make sure to turn off the electricity at the main fuse box. All wiring should be done in accordance with national and local electrical codes. Additionally, it is important to properly ground the ceiling fan as a precautionary measure against possible electrical shock. Following these guidelines will help ensure the safe installation and operation of your ceiling fan.

Do not use a variable (rheostat) wall controller or dimmer switch to operate this fan. Doing so can cause damage to the ceiling fan's remote control unit. It is recommended to only use the provided remote control.

# Installation

1

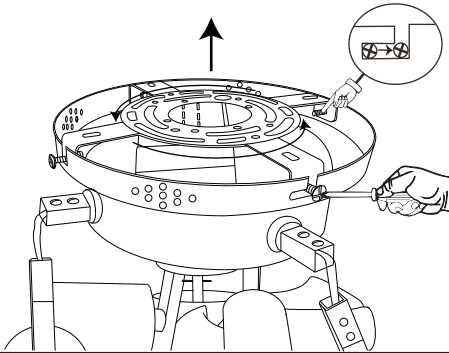

2

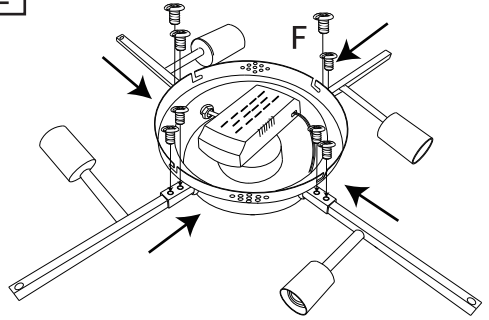

- Loosen the four canopy screws (don't take off) and then twist counterclockwise to remove the mounting plate.
- Insert the rod on lamp socket side into the reserved rod on the canopy, and then secure with 2 screws.

3

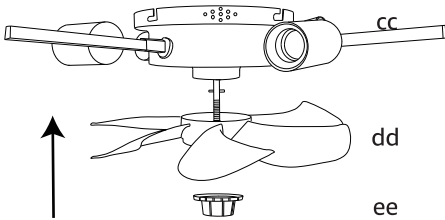

4

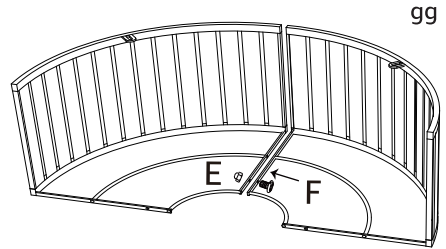

- Put the fan blade onto the motor core, and then use cap to fix counterclockwise.
- Put the frames together and tighten with screws and nuts from bottom. (mid place)

5

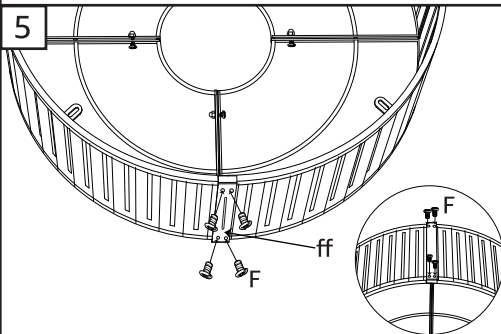

6

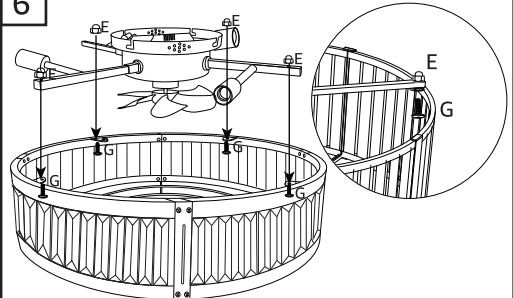

- Attach the connecting component to the frame's connecting part ff, then assemble the lamp frame using four side screws.
- Fix the fan motor host and the frame with 4 screws and nuts.

# Installation

7

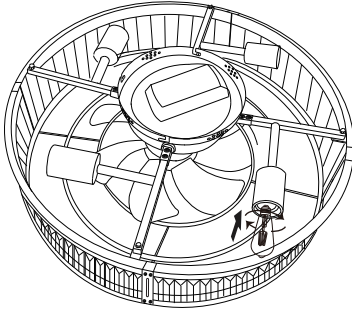

8

Junction box

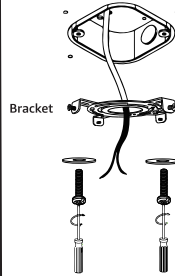

Cement ceiling

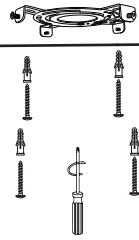

- Screw bulbs to the sockets from back. (Bulbs not included)  
Instructions: Only suitable for E12 LED light bulb 10W MAX/BULB.
- According to the user's ceiling situation, choose the corresponding installation method.  
**Junction box:** Use J-box screws and washers to secure the bracket to the ceiling.  
**Cement ceiling:** Drill holes into the cement ceiling, then use expansion tubes and self-tapping screws for fixation.

9

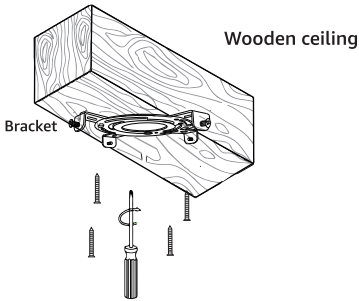

10

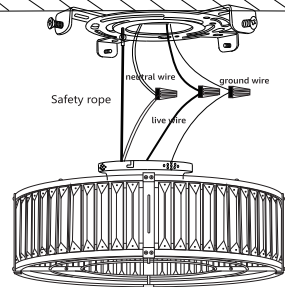

- **Wooden ceiling:** Drive self-tapping screws directly into the wooden ceiling.
- **Tip:** To facilitate wiring, you can use a safety rope to hang the lamp body. Connect the "Neutral wire" (white wire) from the ceiling to the white wire of the ceiling fan. Connect the "Live wire" (black wire) from the ceiling to the black wire of the ceiling fan. Connect the "Ground wire" (green or yellow/green or bare) from the ceiling to the wire from the ceiling fan.

11

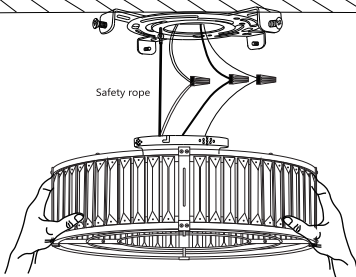

12

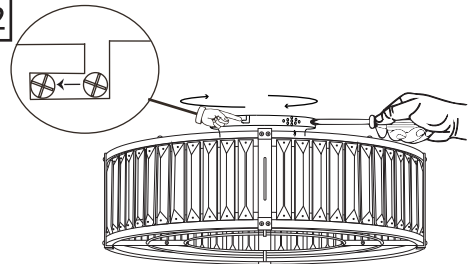

- Align the grooves on the canopy with the screws on the bracket, and then push the fixture upwards.
- Rotate the ceiling fan to align with the grooves, then tighten all 4 screws.

# Operate Your Ceiling Fan

## **WARNING**

To prevent serious injury or death, disconnect power at the circuit breaker before beginning installation.

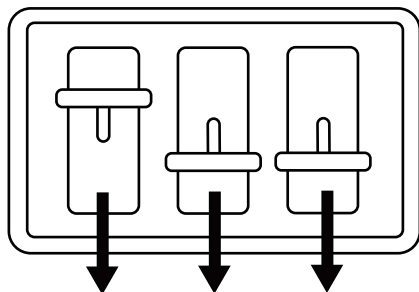

**OFF**

## **IMPORTANT**

To prevent malfunction or damage, do not connect this device to any dimmer switch or variable-speed fan controller.

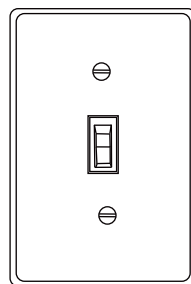
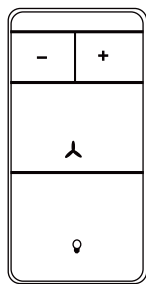
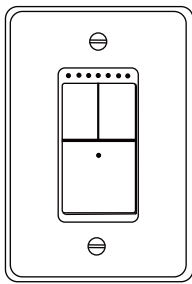
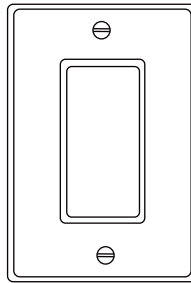
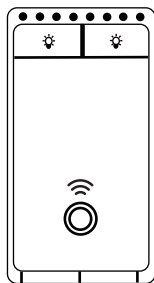
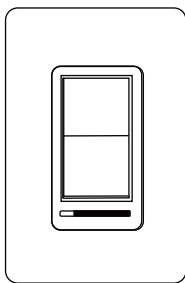
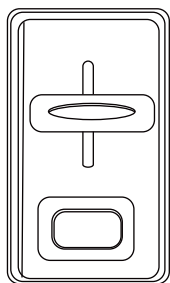

# Remote Control

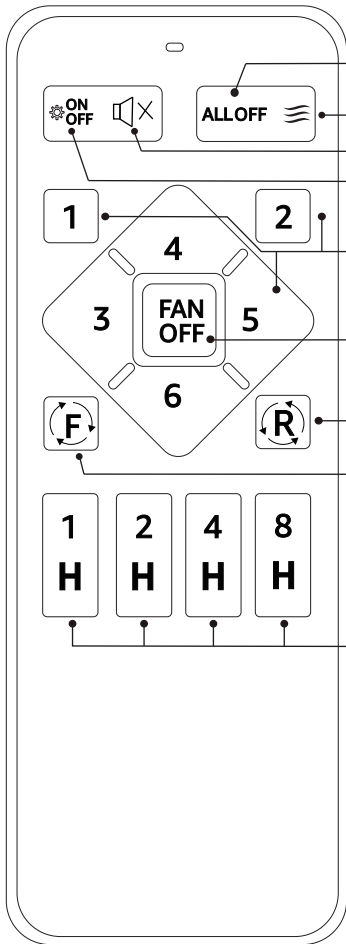

Light & fan all off

Natural wind

Remote controller mute

Light on/off

Fan speed (L1-L6)

Fan off (Long-press within 5s after wall switch on to pair)

Reverse

Forward

Fan stop & light off after 1,2,4,8 hours.

Attach wall plate using the two screws provided.

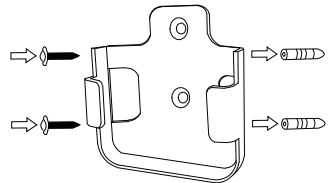

To operate the fan, please install 2 AAA batteries (included) in the handheld remote transmitter. If not used for extended periods of time, remove the batteries to prevent damage to the transmitter. Store the remote away from excessive temperatures and humidity.

Pairing method: (single/multiple fans)

The remote control transmitter can be used to control multiple receivers.

1. For the ceiling fan you want to pair, turn the main power switch off for at least 60 seconds.

2. Turn on the main power switch of the ceiling fan, then immediately press and hold  button for 5 seconds until hear a beep.

3. Wait for the receiver to emit a beep sound, then release the button, and the pairing process is complete.

If the pairing process is unsuccessful, repeat steps 1 through 3 after turning off wall switch 1 minute.

# APP Control

**NOTE: Please enable Bluetooth and pair the fan with app to control it!**



1. Ensure Bluetooth is enabled on your mobile device.

2. Make sure you allow this app to access Bluetooth. (For iPhone users, Android users can ignore this step.)  
 Method 1: Click "Allow" when opening the app for the first time.  
 Method 2: Go to your phone's settings, find the app, and enable Bluetooth access.

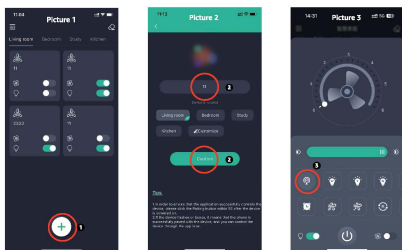

Picture 1

3. Enter the app page and click the plus sign below (Add group).

Picture 2

4. Enter any name, then click Confirm.

Picture 3

5. Turn on the fan's power wall switch, once the light is on, press the pairing button within 5s. The fan light will flash twice to indicate successful pairing.

	Turn on the fan's power wall switch, once the light is on, press the pairing button within 5s. When the fan light flashes twice, it indicates that the fan has been successfully paired with the phone and can now be controlled through the phone.
	Slide to change the fan speed
	Slide to change the brightness of the light
	Quick switch for "Natural" light color
	Quick switch for "Yellow" light color
	Quick switch for "White" light color
	Not available for this model
	Timer the fan
	Natural wind: fan speed will change automatically when use this function
	Sleeping wind
	Night light (10% brightness in neutral white)
	Not available for this model
	Fan moves forwards
	Fan moves reversely
	Oscillating Funtion (Not available for this model)
	Light off/on
	Fan off/on

# Troubleshooting

PROBLEM	SUGGESTED REMEDY
If Fan Does Not Start	<ol style="list-style-type: none"><li>1. Check the main and branch circuit fuses or circuit breakers.</li><li>2. Ensure that the wall control is turned "ON", do not use dimmer switch.</li><li>3. Check the line wire connections to the fan and switch wire connections in the switch housing.</li></ol> <p>CAUTION: Make sure to turn off the main power before making any electrical connections.</p>
If The Fan Sounds Noisy	<ol style="list-style-type: none"><li>1. Make sure all screws in the motor housing are snug (not over tightened).</li><li>2. Check that wire connectors in the switch housing are not rattling against each other or the interior wall of the switch housing. CAUTION: Turn off the main power before entering the switch housing.</li><li>3. Ensure that the securing screws are tight. Make sure the light bulb is tight in the socket and not touching the lamp frame or blades.</li><li>4. Note that some fan motors are sensitive to signals from solid-state variable speed controls. DO NOT USE a solid-state variable speed control.</li><li>5. Allow a "break-in" period of 24 hours. Most noises associated with a new fan will disappear after this period.</li><li>6. Check if the fan blades are in contact with the light bulb. If so, adjust the angle of the light arm and tighten it again.</li></ol>
If Fan Wobbles	<ol style="list-style-type: none"><li>1. Make sure that the canopy and mounting plate are tightened securely to the ceiling junction box, and the junction box is mounted firmly to the ceiling joist.</li><li>2. Check if the fan blades are in contact with the light bulb. If so, adjust the angle of the light arm and tighten it again.</li></ol>
If Light Does Not Work	<ol style="list-style-type: none"><li>1. Check the black wiring of motor to receiver, and receiver to AC input.</li><li>2. Check for loose or disconnected wires in the fan switch housing.</li><li>3. Check for loose for light bulbs.</li><li>4. Check for faulty light bulbs, make sure the light bulb is AC120V and E26 medium base.</li></ol> <p>CAUTION: Make sure the main circuit is turned off before entering the switch housing.</p>
Remote Does Not Work	<ol style="list-style-type: none"><li>1. Battery out of power or not installed correctly; change new AAA battery and ensure well installed.</li><li>2. Re-pairing the remotor by Long-pressing "FAN OFF" within 5s after wall switch on to pair.</li></ol>

# Customer Service

## 30-Days Full Refund Guarantee

If you are not completely satisfied or the item isn't what you expected, just tell us within 30 days. We will give you a full refund unconditionally.

## Friendly Reminder

It's better to contact us than leaving a negative shopping experience. Nothing is more important than your satisfaction, and we will do our best to serve you.

## Quick Response within 12 Hours

You can contact us without any hesitation at any time of the day, and we will reply to you within 12 hours. ( It would be appreciated if you could provide us with a video or pictures, if available)

## 2-year Warranty

Your fan light comes with a two-year warranty. If a malfunction occurs due to product quality issues, we will assist in diagnosing the problem and provide replacement parts free of charge to ensure your fan light resumes normal operation.